



Risk Management Series

Design Guide

for Improving Hospital Safety
in Earthquakes, Floods, and High Winds

FEMA 577 / June 2007



FEMA

About the Cover

Olive View Hospital Replacement Fares Well In 1994 Quake

The new Olive View hospital building shown on the cover performed well during the 1994 Northridge earthquake. This quake, of the same magnitude as the 1971 San Fernando Earthquake that nearly collapsed the original building, caused no serious damage. Built in 1970, the Medical Treatment and Care Building of the Olive View Hospital complex was designed to meet the earthquake provisions of building codes in place at that time. The hospital incurred heavy damage (at left) during the 1971 earthquake and was subsequently rebuilt to stricter design and construction standards.



Olive View Hospital After the 1971 Magnitude 6.7 San Fernando Earthquake

PHOTO CREDIT: E.V. LEYENDECKER, U.S. GEOLOGICAL SURVEY

RISK MANAGEMENT SERIES

Design Guide *for*
Improving Hospital Safety
in Earthquakes, Floods,
and High Winds

PROVIDING PROTECTION TO PEOPLE AND BUILDINGS



FEMA

Any opinions, findings, conclusions, or recommendations expressed in this publication do not necessarily reflect the views of FEMA. Additionally, neither FEMA nor any of its employees makes any warranty, expressed or implied, or assumes any legal liability or responsibility for the accuracy, completeness, or usefulness of any information, product, or process included in this publication. Users of information from this publication assume all liability arising from such use.

BACKGROUND

The United States is currently in the middle of the biggest hospital construction boom in more than 50 years. According to data from the U.S. Census Bureau, spending for construction of new hospitals and other medical facilities increased 65 percent between 2000 and 2006. New scientific and technological innovations, as well as advancements in medical practice and the organization of health care, demand a physical environment different from the hospitals of the past. This demand is being met by the increasing use of evidence-based design, which relies on a combination of scientifically proven research and the evaluation of completed projects to make design and construction decisions that improve the safety and functionality of hospital buildings.

Architects and engineers now look at credible research related not just to structural and mechanical engineering, but also to clinical outcomes, behavioral science, the environment, and technology. New building designs are now seen as important components that can improve medical outcomes, patient safety, employee satisfaction, and even financial performance. The effective use of evidence-based design requires continuous and timely updates of the information that affects hospital design. As part of this effort, the Federal Emergency Management Agency (FEMA) has developed this Design Guide to provide the designers of new hospitals and retrofits to existing ones with the latest information and research results on the best practices to reduce the risks from natural hazards.

This publication is the latest addition to FEMA's Risk Management Series, which provides guidelines for mitigating the risks associated with multiple hazards. The series emphasizes mitigation best practices for specific

building uses and occupancies, such as schools, critical facilities, commercial buildings, and multi-family dwellings.

OBJECTIVE AND SCOPE

The objective of the “*Design Guide for Improving Hospital Safety in Earthquakes, Floods, and High Winds*” is to inform and assist design professionals, hospital administrators, and facility managers in implementing sound mitigation measures that will decrease the vulnerability of hospitals to disruptions caused by natural hazard events. The intent of the Design Guide is to provide its audience with state-of-the-art knowledge on the variety of vulnerabilities faced by hospitals exposed to earthquakes, flooding, and high-winds risks, as well as the best ways to mitigate the risk of damage and disruption of hospital operations caused by these events.

The information presented in this publication provides an exhaustive review of mitigation measures and design solutions that can improve the safety of hospitals in natural hazard events. However, this publication is not intended to be a comprehensive mitigation design manual that the reader can use to develop actual plans and specifications. It is intended as an introduction to the fundamental principles of natural hazard risk reduction, with an emphasis on mitigation planning and the design of hospital buildings. The information presented here is intended to help design professionals, hospital administrators, and facility managers understand the broad aspects of risk reduction methods and strategies, and integrate them into hospital designs.

ORGANIZATION AND CONTENT

The Design Guide is organized around three specific natural hazards: earthquakes, floods, and high winds. It comprises four main chapters.

Chapter 1 presents an overview of the principal considerations determining hospital design, from standard industry requirements to new developments that are transforming both hospital operations and organization of the physical environment. It highlights the known vulnerabilities of hospitals and the repercussions of damage caused by natural hazard events that frequently interfere with the operation of these facilities. The chapter concludes with a look at the multi-hazard approach to hospital design, and provides basic guidelines on the interaction between the responses of building components to various natural hazard risks.

Chapter 2 examines potential earthquake damage to hospitals, and how these facilities can most efficiently improve their performance. The

chapter opens with an introductory discussion on the nature and probability of earthquakes, and procedures for determining seismic risk to specific locations. Typical seismic damages, and the possible resulting effects on building functions or risk to occupants, are described and related to the standard damage states currently used in performance-based earthquake engineering design. The chapter ends with a review of the best practices in seismic design and seismic retrofit of hospital facilities.

Chapter 3 discusses the nature of flood forces and their effects on buildings. It outlines the procedures for risk assessment and describes the current mitigation measures for reducing flood damage. It emphasizes the benefits of avoiding construction of new hospitals in high-risk areas, describes regulatory design requirements that help reduce the exposure of hospitals that must be located in flood hazard areas, and encourages the application of appropriate mitigation measures to existing hospitals at risk of flooding.

Chapter 4 discusses the effects of wind forces on hospitals' structural and nonstructural building components. By reviewing numerous examples of wind-induced damage to these facilities, this chapter highlights the best mitigation practices for new hospital design and construction, and for the rehabilitation of existing facilities. It concentrates on the building components that are the most critical for maintaining uninterrupted operation of hospitals, and provides detailed guidelines for improving their design and construction.

At the end are Appendix A, which contains a list of acronyms, and Appendix B, which contains a glossary of terms that appear in the Design Guide.

ACKNOWLEDGMENTS

Principal Authors:

Christopher Arnold, Building Systems Development, Inc.

William B. Holmes, Rutherford and Chekene

Rebecca C. Quinn, RCQuinn Consulting, Inc.

Thomas L. Smith, TlSmith Consulting

Bogdan Srdanovic, URS Corporation

Wilbur Tussler, Consultant

Contributors:

Milagros Nanita Kennett, FEMA, Project Officer, Risk Management Series Publications

Eric Letvin, URS Corporation, Project Manager

Susan Patton, URS Corporation

Rob Fernandez, URS Corporation

Ivy Porpotage, URS Corporation

Wanda Rizer, design4impact

Project Advisory Panel:

Amar Chaker (AEI), American Society of Civil Engineers (ASCE)

Ken Dickerman, AIA Academy of Architecture and Health

Skip Gregory, Florida Agency for Health Care Administration

Mike Kuechenmeister, American Society of Healthcare Engineering

Jim Rossberg (SEI), American Society of Civil Engineers (ASCE)

John Sullivan, Portland Cement Association

This manual will be revised periodically, and FEMA welcomes comments and suggestions for improvements in future editions. Please send your comments and suggestions via e-mail to:

RiskManagementSeriesPubs@dhs.gov

TABLE OF CONTENTS

FOREWORD AND ACKNOWLEDGMENTS i

 Background i

 Objective and Scope ii

 Organization and Contents ii

 Acknowledgements iii

1 HOSPITAL DESIGN CONSIDERATIONS 1-1

1.1 Introduction 1-1

1.2 Health Care Industry 1-3

 1.2.1 Ambulatory Care 1-3

 1.2.2 Patient Volume 1-4

 1.2.3 Aging Facilities 1-5

 1.2.4 Healing Environments 1-5

 1.2.5 Technological Advances 1-6

1.3 Hazard Mitigation 1-8

 1.3.1 Assessing Risk 1-9

 1.3.2 Evacuation Considerations 1-10

 1.3.3 Potential Vulnerabilities 1-11

1.3.3.1	Structural Vulnerability.....	1-12
1.3.3.2	Nonstructural Vulnerability.....	1-12
1.3.3.3	Spatial and Other Organizational Vulnerabilities.....	1-15
1.4	Hospital Design and Construction.....	1-17
1.4.1	Building Codes.....	1-18
1.5	Multi-Hazard Design Considerations.....	1-20
1.5.1	The Need for a Multi-Hazard Approach.....	1-21
1.5.2	Multi-Hazard Design Matrix.....	1-22
1.6	References.....	1-32
2	MAKING HOSPITALS SAFE FROM EARTHQUAKES.....	2-1
2.1	Introduction.....	2-1
2.1.1	The Nature and Probability of Earthquakes.....	2-1
2.1.2	Earthquake Effects.....	2-2
2.1.3	Measuring Earthquake Effects.....	2-3
2.1.3.1	Measuring Seismic Ground Motion.....	2-5
2.1.3.2	Measuring Potential for Liquefaction.....	2-7
2.1.3.3	Measuring Potential for Landslide.....	2-7
2.1.3.4	Measuring Potential for Tsunami and Seiche.....	2-8
2.1.4	Earthquakes: A National Problem.....	2-8
2.2	Seismic Building Design.....	2-11
2.2.1	The Equivalent Lateral Force (ELF) Analysis Methodology.....	2-12
2.2.1.1	Acceleration.....	2-13
2.2.1.2	Amplification and Soil Type.....	2-14
2.2.1.3	Building Period.....	2-15
2.2.2	Critical Building Characteristics.....	2-16
2.2.2.1	Period and Resonance.....	2-16
2.2.2.2	Damping.....	2-16
2.2.2.3	Nonlinear Behavior.....	2-17

2.2.2.4	Ductility	2-17
2.2.2.5	Strength and Stiffness	2-18
2.2.2.6	Drift	2-19
2.2.2.7	Configuration: Size and Shape	2-20
2.2.2.8	Stress Concentrations.....	2-20
2.2.2.9	Torsional Forces.....	2-21
2.2.3	Specifications for Performance-Based Seismic Design	2-24
2.2.3.1	Performance Levels.....	2-24
2.2.3.2	New Developments in Performance-Based Design.....	2-27
2.3	Earthquake Damage to Hospitals	2-29
2.3.1	Types of Structural Damage	2-31
2.3.1.1	The Case of the Olive View Medical Center.....	2-32
2.3.2	Nonstructural Damage	2-35
2.3.2.1	The Case of New Olive View Medical Center	2-39
2.3.2.2	The Case of Kona Community Hospital, Hawaii	2-42
2.3.3	Consequences of Building Damage	2-48
2.3.4	Seismic Vulnerability of Hospitals	2-49
2.3.4.1	Seismic Vulnerability of Hospitals Based on Historical Performance in California.....	2-50
2.3.4.2	Vulnerability Assessment of Hospital Buildings	2-52
2.3.4.3	Comparability of Hospital Buildings.....	2-53
2.4	Risk Reduction Measures	2-57
2.4.1	Site Selection Basics.....	2-57
2.4.2	Seismic Design Basics	2-58
2.4.3	Structural Systems.....	2-59
2.4.3.1	Basic Types of Lateral Force Resisting Systems	2-59
2.4.3.2	Innovative Structural Systems.....	2-62
2.4.3.3	Structural Systems Selection	2-63
2.4.4	Nonstructural Components and Systems.....	2-64
2.4.4.1	Code Regulated Nonstructural Systems.....	2-65
2.4.4.2	Interstitial Space for Utility Installations	2-67

2.4.5	Mitigation Measures for New Buildings	2-68
2.4.5.1	The Case of Loma Linda Veterans Hospital.....	2-68
2.4.6	Mitigation Measures for Existing Buildings.....	2-72
2.4.6.1	Procedures and Design Strategies for Rehabilitation of Structural Systems	2-72
2.4.6.2	The Case of Naval Hospital Bremerton	2-73
2.4.6.3	Procedures and Design Strategies for Rehabilitation of Nonstructural Systems	2-77
2.4.6.4	Summary of Risk Reduction Measures for Existing Buildings	2-77
2.5	Checklist for Seismic Vulnerability of Hospitals	2-80
2.6	References and Sources of Additional Information	2-84
3	MAKING HOSPITALS SAFE FROM FLOODING	3-1
3.1	General Design Considerations	3-1
3.1.1	The Nature of Flooding	3-1
3.1.2	Probability of Occurrence or Frequency	3-4
3.1.3	Flood Characteristics and Loads.....	3-7
3.1.3.1	Hydrostatic Loads.....	3-9
3.1.3.2	Hydrodynamic Loads	3-10
3.1.3.3	Debris Impact Loads	3-12
3.1.3.4	Erosion and Local Scour	3-13
3.1.4	Design Parameters.....	3-14
3.1.4.1	Flood Depth	3-14
3.1.4.2	Design Flood Elevation	3-17
3.1.4.3	Flood Velocity—Riverine	3-17
3.1.4.4	Flood Velocity—Coastal	3-18
3.1.5	Flood Hazard Maps and Zones.....	3-19
3.1.5.1	NFIP Flood Maps.....	3-20
3.1.5.2	NFIP Flood Zones.....	3-21
3.1.5.3	Coastal A Zones	3-24

3.1.6	Floodplain Management Requirements and Building Codes	3-26
3.1.6.1	Overview of the NFIP	3-26
3.1.6.2	Summary of the NFIP Minimum Requirements	3-28
3.1.6.3	Executive Order 11988 and Critical Facilities	3-29
3.1.6.4	Scope of Model Building Codes and Standards	3-30
3.2	Hospitals Exposed to Flooding	3-33
3.2.1	Identifying Flood Hazards at Existing Hospitals	3-33
3.2.2	Vulnerability: What Flooding Can Do to Existing Hospitals	3-33
3.2.2.1	Site Damage	3-34
3.2.2.2	Structural Damage.....	3-36
3.2.2.3	Nonstructural Damage.....	3-38
3.2.2.4	Medical Equipment.....	3-41
3.2.2.5	Utility System Damage.....	3-41
3.2.2.6	Contents Damage	3-44
3.3	Requirements and Best Practices in Flood Hazard Areas	3-47
3.3.1	Evaluating Risk and Avoiding Flood Hazards.....	3-47
3.3.2	Benefits and Costs: Determining Acceptable Risk	3-48
3.3.3	Site Modifications	3-50
3.3.4	Elevation Considerations	3-53
3.3.4.1	The Case of Boulder Community Foothills Hospital, Boulder, Colorado	3-58
3.3.5	Dry Floodproofing Considerations	3-63
3.3.6	Flood-Resistant Materials	3-66
3.3.7	Access Roads	3-68
3.3.8	Utility Installations	3-69
3.3.9	Potable Water and Wastewater Systems.....	3-71
3.3.10	Storage Tank Installations	3-71
3.3.11	Accessory Structures	3-72
3.4	Risk Reduction for Existing Hospitals	3-73
3.4.1	Introduction.....	3-73

3.4.2	Site Modifications	3-73
3.4.3	Additions	3-75
3.4.4	Repairs, Renovations, and Upgrades.....	3-77
3.4.5	Retrofit Dry Floodproofing	3-78
	3.4.5.1 The Case of Pungo District Hospital, Belhaven, North Carolina.....	3-79
3.4.6	Utility Installations	3-84
3.4.7	Potable Water and Wastewater Systems.....	3-86
3.4.8	Other Damage Reduction Measures	3-87
3.4.9	Emergency Measures.....	3-88
3.5	Checklist for Building Vulnerability of Flood-Prone Hospitals.....	3-90
3.6	References and Sources of Additional Information	3-98
4	MAKING HOSPITALS SAFE FROM HIGH WIND	4-1
4.1	General Design Considerations	4-1
4.1.1	Nature of High Winds	4-3
4.1.2	Probability of Occurrence.....	4-3
4.1.3	Wind/Building Interactions	4-5
4.1.4	Building Codes.....	4-9
	4.1.4.1 Scope of Building Codes.....	4-9
	4.1.4.2 Effectiveness and Limitations of Building Codes.....	4-10
4.2	Hospitals Exposed to High Winds	4-13
4.2.1	Vulnerability: What High Winds Can Do to Hospitals.....	4-13
	4.2.1.1 Types of Building Damage.....	4-13
	4.2.1.2 Ramifications of Damage	4-16
	4.2.1.3 The Case of West Florida Hospital, Pensacola, Florida	4-17
4.2.2	Evaluating Hospitals for Risk From High Winds.....	4-24
	4.2.2.1 New Buildings	4-24
	4.2.2.2 Existing Buildings.....	4-25

4.3	Requirements and Best Practices In High-Wind Regions	4-26
4.3.1	General Hospital Design Considerations.....	4-26
4.3.1.1	Site	4-28
4.3.1.2	Building Design	4-29
4.3.1.3	Construction Contract Administration.....	4-34
4.3.1.4	Post-Occupancy Inspections, Periodic Maintenance, Repair, and Replacement.....	4-35
4.3.1.5	Site and General Design Considerations in Hurricane-Prone Regions	4-36
4.3.2	Structural Systems	4-37
4.3.2.1	Structural Systems in Hurricane-Prone Regions.....	4-41
4.3.3	Building Envelope	4-42
4.3.3.1	Exterior Doors	4-42
4.3.3.2	Exterior Doors in Hurricane-Prone Regions.....	4-46
4.3.3.3	Windows and Skylights.....	4-47
4.3.3.4	Windows and Skylights in Hurricane-Prone Regions	4-49
4.3.3.5	Non-Load-Bearing Walls, Wall Coverings, and Soffits	4-52
4.3.3.6	Non-Load-Bearing Walls, Wall Coverings, and Soffits in Hurricane-Prone Regions	4-64
4.3.3.7	Roof Systems	4-65
4.3.3.8	Roof Systems in Hurricane-Prone Regions.....	4-74
4.3.3.9	The Case of DeSoto Memorial Hospital, Arcadia, Florida	4-81
4.3.4	Nonstructural Systems And Equipment.....	4-85
4.3.4.1	Exterior-Mounted Mechanical Equipment	4-86
4.3.4.2	Nonstructural Systems and Mechanical Equipment in Hurricane-Prone Regions.....	4-94
4.3.4.3	Exterior-Mounted Electrical and Communications Equipment	4-94
4.3.4.4	Lightning Protection Systems (LPS) in Hurricane- Prone Regions.....	4-97
4.3.4.5	The Case of Martin Memorial Medical Center, Stuart, Florida	4-102

4.3.5	Municipal Utilities in Hurricane-prone Regions.....	4-104
4.3.5.1	Electrical Power	4-104
4.3.5.2	Water Service	4-105
4.3.5.3	Sewer Service	4-106
4.3.6	Post-design Considerations In Hurricane-Prone Regions	4-106
4.3.6.1	Construction Contract Administration	4-106
4.3.6.2	Periodic Inspections, Maintenance, and Repair	4-106
4.4	Remedial Work on Existing Facilities	4-107
4.4.1	Structural Systems.....	4-109
4.4.2	Building Envelope	4-111
4.4.2.1	Sectional and Rolling Doors.....	4-111
4.4.2.2	Windows and Skylights.....	4-112
4.4.2.3	Roof Coverings	4-115
4.4.3	Exterior-Mounted Equipment	4-117
4.4.3.1	Antenna (Communications Mast)	4-117
4.4.3.2	Lightning Protection Systems.....	4-118
4.4.4	The Case of Baptist Hospital, Pensacola, Florida.....	4-118
4.5	Best Practices in Tornado-Prone Regions.....	4-122
4.5.1	The case of Kiowa County Memorial Hospital, Greensburg, Kansas	4-126
4.5.2	The case of Sumter Regional Hospital, Americus, Georgia	4-135
4.6	Checklist for Building Vulnerability of Hospitals Exposed to High Winds	4-141
4.7	References and Sources of Additional Information	4-147

APPENDICES

Appendix A	Acronyms.....	A-1
Appendix B	Glossary of Terms	B-1

1.1 INTRODUCTION

Most Americans are accustomed to receiving sophisticated and prompt medical attention after an injury or a medical problem occurs, anytime and anywhere in the country, without traveling great distances. Such expectations are even greater during mass emergencies that require immediate care for a large number of casualties. In circumstances in which hospital operations are disrupted or completely disabled, the adverse effects of such disasters can be quickly compounded, frequently with catastrophic results. A recent report from the Congressional Research Service (CRS), *Hurricane Katrina: the Public Health and Medical Response*, examined the performance of the public health system during this devastating event. According to the CRS report, Hurricane Katrina pushed some of the most critical health care delivery systems to their limits, for the first time in recent memory (Lister, 2005). Therefore, the importance of uninterrupted hospital operations and ready access to, and availability of, immediate medical care cannot be exaggerated.

The intent of this publication is to provide guidelines for planning, design, and construction of new hospitals and rehabilitation of existing ones, for the purpose of improving their performance during, and in the immediate aftermath of, seismic, flooding, and high-wind events. It is important to acknowledge that there are no universal design guidelines to protect buildings from all such events. Different natural phenomena present different challenges, and each hazard requires a different approach and a different set of recommendations. When communities face more than one of these hazards, the design team must select the mitigation measures most appropriate for achieving the desired performance level, regardless of the immediate cause for the potential losses.

For instance, flooding is a more site-specific hazard than others. The preferred approach for new facilities is to select a site that is not subject to flooding. When that is not feasible, site modifications or other site-specific building design features that mitigate anticipated flood hazard will reduce the potential for damage. When it comes to seismic and high-wind events, however, in addition to carefully selecting the site, it is necessary to design the buildings to be resistant to the variety of forces associated with these phenomena. The protection against seismic forces requires that both structural and non-structural building components have sufficient resistance. For high winds, protection efforts focus mainly on the exposed building components and systems.

This chapter addresses the general issues that influence the operations and hospital building designs. Typically, the design of hospital facilities is driven by their function and the type of services they provide to the community. These services are constantly evolving in response to trends in the health care industry and changing expectations of health care customers. Some of these health care trends have been the logical result of advances in medical science and technology, while the others, driven by social and economic conditions, represent new approaches to management of medical care. Additionally, hospital design has been greatly influenced by the recognition that physical environment has a measurable influence on human well-being. A growing body of evidence has been accumulated that shows how appropriate hospital designs can create the healing environments that improve patient treatment outcomes and patient care in general. Increasingly, hospital designers are expected to use this new evidence-based design approach when designing new hospitals.

In order to design effective medical facilities for the future, designers must be familiar with the latest industry developments, building requirements stemming from these trends, and the latest research findings on the impact of building designs on hospital operations, staff and patient morale, and patient care. It is the purpose of this Design Guide to add to these general considerations the issues of buildings' resistance to natural hazards and recommended hazard mitigation measures for risk reduction.

1.2 HEALTH CARE INDUSTRY

1.2.1 AMBULATORY CARE

In the last 30 years or so, the health care industry has increasingly been moving toward greater emphasis on ambulatory care. The increasing availability of procedures that can be successfully completed without an overnight stay in the hospital has led to a proliferation of freestanding ambulatory care centers. Many of these centers are performing sophisticated surgeries and complicated diagnostic procedures. Frequently, these centers are not affiliated, or are only loosely affiliated with, other hospitals in the community.

The emphasis on the ambulatory care had a profound effect on the healthcare industry, leading to the reduction in the number of hospital beds and, in many cases, closing of hospitals because of the reduced demand for overnight stays. At the same time, hospitals had to increase their own role in ambulatory care to remain competitive. As the freestanding ambulatory facilities took an ever-increasing market share, many hospitals had to downsize, and in some cases, scale back even their surgical capacity. In many respects, this development has diminished the capacity of medical facilities to care for the casualties in the event of a disaster, because most of the freestanding ambulatory care centers are not suitable for post-disaster emergency care. There are several reasons for this:

- They do not have dedicated emergency departments or adequate facilities and equipment to deal with trauma patients.
- They are not available or staffed on a 24-hour, 7 days-a-week basis.
- They are not adequately equipped with emergency communications systems.
- The staff is not experienced or well trained to care for the types of patients and injuries expected in post-disaster emergencies.

- These facilities are not considered essential and are sometimes built to a lower building code standard than hospitals, which makes them more vulnerable to disruption resulting from building damage.

On the other hand, hospital-based ambulatory care (outpatient) departments can easily be converted for post-disaster care during an emergency, assuming the hospital itself remains operational. Hospital-based ambulatory surgeries are often contiguous to surgery for inpatients. Clinic space can be used for triage or emergency treatment rooms, and the ambulatory diagnostic equipment is suitable for use in an emergency. The key to having hospital-based ambulatory capacity available in the aftermath of major disasters is thoughtful planning, so that the emergency department can remain the command center, coordinating other areas of the hospital where post-disaster patients might be transferred and treated.

1.2.2 PATIENT VOLUME

Hospital emergency rooms have become the primary source of medical care for millions of people. Unlike other medical facilities, hospitals are required to treat anyone who walks in, or is brought in, irrespective of their insurance status or ability to pay. This trend puts an enormous pressure on emergency departments, not only because it increases the patient load, but also because it expands their functions beyond the treatment of emergency and trauma cases.

As a result, many hospitals have enlarged and better equipped their emergency departments to accommodate the ever-increasing patient load, which had a positive influence on their capacity to deal with disaster-related emergencies. Additionally, hospital emergency departments are well trained in triage that involves prioritization of cases according to the level of medical urgency. Patients who are most in need of immediate treatment are treated first, while the others who can wait without harm are treated later. Emergency department staff members also go through extensive disaster drills, and in most cases are well trained to respond to mass emergencies.

Despite current hospital construction boom, the trend towards reduced inpatient capacity in the past decades has adversely affected hospitals' readiness for emergencies. In 1990, the national average was 372 hospital beds per 100,000 people, whereas in 2004 there were only 275 beds. The number of hospitals in the country¹ dropped from 5,384 in 1990 to 4,919 in 2004. This has reduced the number of hospital beds in many commu-

¹ Data from Trendwatch Chartbook 2006, by the American Hospital Association and the Lewin Group.

nities to the point where some rural communities were left without any acute inpatient capacity.

As a result of hospital closures and inpatient capacity reduction, occupancy rates in the remaining hospitals have increased. The increase means that most hospitals are operating at near-maximum inpatient capacity on a regular basis, making it difficult to accommodate a potential influx of casualties in a disaster emergency. Some reports, especially those that analyzed the response to Hurricane Katrina, singled out the limited surge capacity for health care emergencies as one of the most pressing problems of the Nation's health care system (see Lister, 2005).

1.2.3 AGING FACILITIES

Renovation and replacement of health facilities have been at record highs in recent years. Still, a majority of hospital buildings throughout the country are of considerable age. A great many of them were built in the 1950s and 1960s, particularly in rural areas, with Federal funding assistance provided by the Hill-Burton Act passed by Congress following World War II. In the 1960s and 1970s, this grant program was also used for replacement and renovation of urban hospitals. As a consequence, a large number of hospitals were built in a short period of time. Many of these hospitals are now nearing the end of their useful life. Even with periodic renovations, there are limits to the value of continued investment in older facilities to be used for acute care.

Hospitals are constantly renovating, whether they are just adding electrical outlets or communications cables, or engaging in more complex projects that involve moving functions and building additions to the existing structures. This kind of change is a result of many factors: changing personnel, new technologies, and competitive pressure. Some changes, however, may affect the use of spaces or facilities originally planned and built for emergency operations. For instance, renovation may inadvertently upset bracing for piping and communications conduits, making them more vulnerable to hazards like earthquakes or high winds. Similarly, functional reorganization of a hospital that makes some critical functions and services more accessible by placing them on the ground floor increases the risks from flooding to these facilities.

1.2.4 HEALING ENVIRONMENTS

Since the advent of the hospital "birthing unit" in the late 1970s, the health industry has shown an increasing interest in the ability of the physical environment to contribute to healing. The growing evidence in-

dicates that a pleasant and comfortable environment reduces stress and provides a sense of well-being, both of which are important preconditions for successful recovery. Additionally, patient satisfaction with hospital services today extends beyond medical care and encompasses a whole hospital experience. To be able to compete successfully with the increasing number of outpatient and other alternative healthcare providers, hospitals have started to pay greater attention to providing a “hospitable” and “healing environment,” in addition to medical expertise, new technology, and advanced procedures.

This trend manifests itself in building designs that introduce the spirit of nature into the hospital environment: more natural light, views of nature and direct access to the outdoors from many more areas of the hospital, and increased use of courtyards and gardens. Hospital gardens have been found to provide not only the restorative and calming nature views, but also help reduce stress by providing opportunities for escape from clinical settings, and by fostering greater social interaction among patients and staff. The social aspect is particularly important for patients who might feel isolated in a sterile hospital environment without the support of their families and friends. Considering the significance of social support for patients’ successful recovery, hospitals are planning for greater involvement of the family in the care of their patients by requiring single-bed rooms for all newly built acute care hospitals. Additionally, hospitals are providing more public spaces that facilitate social interaction, such as lounges, atria, and interior streets with shops and restaurants that were not part of the traditional hospital environment.

The advent of new hospital architecture, especially the new physical arrangements designed to assist in healing have, in many respects, increased the exposure of hospital buildings to natural hazards. The emphasis on natural light, the use of single-patient rooms, and a greater variety of public spaces usually produces complex building designs with greater exterior perimeter and a greater number of doors and windows that frequently increase building’s vulnerability to wind and windborne debris damage.

1.2.5 TECHNOLOGICAL ADVANCES

New and emerging technologies ranging from new electronic devices, such as nanoscale sensors, to new wireless communication networks are rapidly changing patient treatment practices as well as the organization of hospitals. These innovative medical technologies help empower the physicians, nurses, and patients with tools that enable faster diagnosis and better treatment of diseases. Most diagnostic practices and procedural functions in clinics and surgeries are dependent on modern instruments,

tools, and laboratory equipment. Today's hospitals are in the process of replacing all analog-based instruments with digital ones. New hospital organization is now based on an IT architecture that maximizes the flow of diagnostic and monitoring data from these instruments through new communications networks and makes them available to hospital staff in making treatment decisions.

Digitized X-rays and other images are being transmitted electronically to all parts of the hospital and to doctors' offices. Clinical laboratory test results, prescriptions, and most forms of medical data are now instantly available to medical practitioners. There is a national movement to adopt a universal electronic medical record, which would make patient's medical history and other information almost instantly available to the treating physician.

These technological innovations substantially changed not only the medical practice, but also turned this new electronic and IT infrastructure into an essential and indispensable backbone of all hospital operations. Therein lays the grave vulnerability of hospitals in cases where this sensitive infrastructure can be disrupted, as was seen in many hospitals affected by Hurricane Katrina. When a disaster, such as Hurricane Katrina, disables or impairs the functioning of electronic equipment and data transmission systems, or even the hospital voice communications systems, the ability of the medical staff to care for their patients is significantly reduced.

Emergency power systems, therefore, become the critical component for maintaining hospital's functions. The dependence on electrical power generators is increasing as the hospitals rely more and more on energy-intensive equipment and procedures. Even if the hospital is designed to continue to care for patients after a disaster, its ability to function is limited by the emergency power supply capacity, the extent of coverage by emergency power systems, and the ability to remain operational for extended periods of time.

A U.S. Department of Energy (DOE) 2002 report ranked healthcare facilities second only to food-service facilities in the intensity of energy use, defined as the amount of energy consumed per square foot of space.

1.3 HAZARD MITIGATION

Mitigation is defined as any sustained action taken to reduce or eliminate long-term risk to life and property from hazard events. The goal is to save lives and reduce property damage in ways that are cost-effective and environmentally sound. Hazard mitigation measures should be integrated into the process of planning and design because they reduce casualties and damage resulting from building failures during hazard events. The effects of a disaster on a hospital, however, are never restricted to the physical damage or the distress among the staff and patients as a result of such damage. Consequences frequently include partial or total loss of the ability to provide services and meet the demand for health care when it is most needed. Incorporating mitigation measures in the design of hospitals is therefore especially important because they minimize the disruption of hospital operations and protect the uninterrupted provision of critical health services.

Advances in building science and technology, and changes in design philosophy and quality assurance techniques for the construction and maintenance of medical infrastructure, now make it possible to limit the damage during seismic, flooding, and high-wind events. The advent of performance-based design allows the use of different levels of protection for different types of infrastructure and operations that frequently exceed the minimum requirements of currently applicable codes. However, it is not always possible to achieve the protection levels one might desire, owing to a variety of factors. Natural or technical barriers may exist, or the funding may be insufficient. Even though financial resources may be limited, and other circumstances may impose technical barriers to the fulfillment of performance objectives, a detailed assessment is still required in order to ensure the optimal utilization of available resources.

The starting point for such an assessment should be a general review of the existing hospital network in the area—its operational characteristics, geographical distribution, the degree to which it is able to meet health

care needs and expectations, the epidemiological and demographic profile of the population served, and the natural hazards that threaten the provision of medical services. The effective functional capacity of all existing hospitals should be taken into account, considering as fully as possible all factual information on the natural hazards they face and their current level of vulnerability. Once the actual characteristics of this network and the potential hazards have been identified, and the need to build a new hospital in a specific location has been established, it is still necessary to define the role that the new facility will play, both in normal times and during emergencies of various kinds and intensities. Based on all this information, the level of overall functional performance should be set for the new facility. The process of determination of the performance level must address the questions of the importance of continued and uninterrupted operation of the facility, as well as the feasibility and cost-effectiveness of such a performance objective.

All this will be influenced by the characteristics of the site, the specifics of the infrastructure to be built, and the basic services it can realistically be expected to provide based on different disaster scenarios. In considering disaster mitigation, the goal should be to provide the community with access to health care in a reasonable period of time, within reasonable travel distances, and to have essential services available to treat patients who sustained injuries as a result of the disaster. At the same time, a hospital needs to continue to care for their pre-disaster patients and ensure that no harm comes to them.

Much of the procedure for a new building described above can apply to hazard mitigation in an existing building as well, with obvious limitations.

1.3.1 ASSESSING RISK

Beyond the building codes in existence at the time a hospital is designed or slated for renovation, the leadership of the facility and the design consultants must address key questions to establish the adequacy of the building's performance in the event of a disaster. Hospitals are under enormous financial pressure. Any funds invested in making a hospital facility safer for patients and staff, more resistant to damage, or capable of continued operations in a post-disaster situation must consider the following questions:

- What types and magnitudes of hazard events are anticipated at the site?
- What are the vulnerabilities of the site or existing building to natural hazards?

- What are the anticipated frequencies of hazard events?
- What level of loss/damage/injury/death, if any, is acceptable?
- What might be the financial impact of extended downtime on the institution?
- What is the impact to the community if the hospital cannot maintain operations in the aftermath of a disaster?

It is not possible to protect against every conceivable event, or to be 100 percent safe and free of damage in a major disaster. The level of acceptable risk must be decided on an individual facility basis by those responsible for the institution and its mission.

1.3.2 EVACUATION CONSIDERATIONS

In anticipation of high winds or flooding, timely evacuation of some or all of the hospital patients to facilities out of the disaster area may sometimes be a prudent choice for patient welfare. The risks of transferring acutely ill patients must be taken into consideration, as pointed out by the General Accounting Office (GAO) report to Congress dated February 16, 2006, titled, *Disaster Preparedness: Preliminary Observations on the Evacuation of Hospitals and Nursing Homes Due to Hurricanes*. It stated: “Administrators consider several issues when deciding to evacuate or to shelter in place, including the availability of adequate resources to shelter in place, the risks to patients in deciding when to evacuate, the availability of transportation to move patients and of receiving facilities to accept patients, and the destruction of the facility’s or community’s infrastructure.”

Many patients have limited mobility and some are on critical life support, oxygen or other medical gasses, ventilators, or IV pumps. Moving these patients to evacuate the hospital is difficult and requires highly trained staff.

In each geographical area, acute care facility managers must evaluate the likely time that they would need to hold patients, how many additional patients might arrive seeking care, and what services would be needed and for what period of time. In the case of Hurricane Katrina, some hospitals evacuated their Neonatal Intensive Care Unit, bariatric patients, and dialysis patients before the storm landfall, which proved both prudent and beneficial. For hospitals planning to retain their dialysis patients, it is essential to assure a constant supply of electricity to power the equipment needed for these patients.

Most hospitals plan to “shelter in place” and weather the storms, rather than evacuate. In order to do this, they must take care of their existing patients, many of whom are critically ill, and in addition, be prepared to accommodate the casualties as well as the increased number of outpatients. In order to accomplish this, there are a wide variety of services that must remain functional. Often municipal utility services will be cut off during a disaster, so alternative power, water, and waste disposal services need to be provided onsite whenever possible. Communication systems are often cut off, so redundancy is a key factor in maintaining links to the outside world as well as internal communications within the hospital. FEMA publications 361 and 543 both address the specific needs of structures to be used as disaster shelters. Sheltering in place can be challenging, but in most cases it is the preferred option for most acutely ill patients.

If there is a plan to evacuate patients, or a probability that patients will need to be evacuated, regional planning with other hospitals in the area and coordination of resources is essential. Agreements and appropriate provisions need to be put in place so that space and staff are available to accommodate evacuated patients. The State of Florida has put in place an evacuation tracking system for all evacuated patients. This might be a useful model for other States to follow.

1.3.3 POTENTIAL VULNERABILITIES

Hospitals provide services that are essential for protecting and safeguarding the health and well-being of a community. The continued provision of these services is even more critical during and in the immediate aftermath of disasters. Considering the complexity of hospital operations, even the smallest breakdown in one of its building or equipment systems can cause serious disruption of hospital functions. This makes the hospitals extremely vulnerable to a variety of natural hazards.

Hospitals usually have high levels of occupancy, with patients, staff, and many visitors present 24 hours a day. Many patients require constant attention, and in many cases continuous specialized care and the use of sophisticated medical instruments or other equipment. Hospital operations also depend on a steady supply of medical and other types of material, as well as public services or lifelines. In addition, hospital vulnerability is aggravated by the presence of hazardous substances that may be spilled or released in a hazard event.

Given the importance of hospital services for response and recovery following emergencies, and the need for uninterrupted operation of these facilities, hospital administrators and designers must consider all aspects

of their vulnerability. Three main aspects of hospital vulnerability must be taken into account:

- Structural
- Nonstructural
- Organizational

1.3.3.1 Structural Vulnerability

Structural vulnerability is related to potential damage to structural components of a building. They include foundations, bearing walls, columns and beams, staircases, floors and roof decks, or other types of structural components that help support the building. The level of vulnerability of these components depends on the following factors:

- The level to which the design of the structural system has addressed the hazard forces
- The quality of building materials, construction, and maintenance
- The architectural and structural form or configuration of a building

The aspects of adequate design and construction in most hazard-prone areas are regulated by building codes and other regulations. The main purpose of these regulations is to protect the safety of occupants. They are usually prescriptive in nature, i.e. they establish minimum requirements that are occasionally updated based on newly acquired knowledge. The building regulations alone, however, cannot guarantee uninterrupted operation of a hospital, because a great many other factors affect hospital functions.

1.3.3.2 Nonstructural Vulnerability

The experience of hospital evacuations and other types of disruption during recent hazard events (many of which are described in greater detail in later chapters) has heightened the awareness that hospital functions could be seriously impaired or interrupted, even when the facilities did not sustain significant structural damage. The effects of damage to nonstructural building components and equipment, as well as the effects of breakdowns in public services (lifelines), transportation, re-supply, or other organizational aspects of hospital operations, can be as disruptive, and as dangerous for the safety of patients, as any structural damage.

Architectural Components

Nonstructural vulnerabilities that can affect hospital functions and the safety of occupants include the potential failures of architectural components, both on the exterior and the interior of buildings.

Damage to roof coverings, facades, or windows can make way for water penetration that can damage sensitive equipment and shut down many hospital functions. When roofing material is disturbed by wind, the roof may start to leak and the moisture can knock out vital equipment, disrupt patient care, and penetrate walls and other concealed spaces, allowing mold to build up over time. Window breakage resulting from high winds, earthquakes, and even flooding frequently requires patient evacuation from affected areas. Patients in critical care and acute care units are particularly vulnerable because the move separates them from medical gas outlets, monitors, lighting, and other essential support services.

Non-load bearing and partition walls and ceilings, for instance, are rarely designed and constructed to the same standards of hazard resistance as the structural elements. Collapse of these components has caused a number of evacuations and closures of hospitals following a hazard event.

Installations

Hospitals are extremely complex building systems that depend on an extensive network of mechanical, electrical, and piping installations. The air and ventilation system is one of the most important ones because it is responsible for maintaining an appropriate environment in different parts of the hospital. Isolation rooms usually have negative pressure so that harmful airborne organisms do not migrate outside the patient's room and infect others. Likewise, wards housing patients with immune system deficiencies require a positive pressure differential, so that harmful organisms do not enter the patient room and needlessly infect them. The malfunction in any one part of this ventilation system could create a risk of infection to patients and staff. This system is extremely vulnerable to disruption as a result of indirect building damage. Winds habitually overturn improperly attached roof-mounted ventilation and air-conditioning equipment, while the ductwork is very susceptible to collapse in earthquakes. Additionally, strong winds may change the airflow from ventilation exhaust outlets, potentially causing harmful discharges from patient care areas and the clinical laboratory to be sucked back into the fresh air intakes. Airborne debris from windstorms could quickly clog the air filtration systems, making them inoperable or impaired.

Hospitals depend on several essential piping systems. Medical gasses are among the most important, along with water, steam, and fire sprinkler systems. Physicians and nurses depend on oxygen and other gasses required for patient care. Unless properly secured and braced, these installations can be easily dislodged or broken, causing dangerous leakage and potential additional damage.

In floods and earthquakes particularly, sewers are apt to overflow, back up, or break down. Waste disposal is essential for any hospital, because when the toilets back up, or sterilizers, dishwashers, and other automated cleaning equipment cannot be discharged, patient care is immediately affected. Retention ponds or holding tanks coupled with backflow and diversion valves can be employed to solve this problem; however, in many hospitals, this issue has not been adequately addressed.

Elevator service is vulnerable not only to power outage, but also to direct damage to elevator installations. Wind and windborne debris can damage elevator penthouses, opening a path for water penetration that can disable elevator motors and controls, as has happened in numerous hurricanes in recent years. In the event of an earthquake, elevator shafts and other equipment can be damaged or dislodged, effectively shutting down the building. Flooding of elevator pits was a common problem during Hurricane Katrina, and responsible for the loss of elevator service.

The emergency power supply system is probably the most critical element in this group. Together with fuel supply and storage facilities, this system enables all the other hospital installations and equipment that have not sustained direct physical damage to function normally in any disaster. However, uninterrupted operation of a hospital during a power outage is possible only if adequate electrical wiring is installed in all the areas that require uninterrupted power supply. Since extra wiring and additional circuits for emergency power increase the initial construction costs of the building, the decision on the emergency power coverage requires a thorough evaluation of the relative vulnerability of various functions to power outage. As patients become more critically ill and the nature of diagnosis and treatment becomes more dependent on computers, monitors, and other electrical equipment, the need for emergency power will continue to grow.

The experience of Hurricane Katrina has demonstrated the need for emergency power coverage even for services that typically have not been regarded as critical, such as climate control and air-conditioning systems. Extreme heat caused a number of hospitals to evacuate their patients and staff when the conditions became unbearable.

Equipment and Furnishings

There are many types of internal hazards that might occur as the result of a disaster. In the past, bottles in clinical laboratories have fallen and started fires. Earthquakes have catapulted filing cabinet drawers and ventilators across rooms at high speed, with the potential of causing considerable injury to personnel. Any wheeled equipment is vulnerable to displacement and has the potential to cause injury.

Electronic communication systems

Hospitals use and depend on many types of communication systems. For communications with emergency vehicles or first response agencies, hospitals depend on radio equipment that is frequently mounted on roofs and exposed to high winds and windborne debris impact. Satellite dishes, communication masts, antennae, and other equipment can be blown off the roof or be severely damaged, leaving the hospital without this vital service at a critical time.

1.3.3.3 Spatial and Other Organizational Vulnerabilities

Most hospitals have disaster mitigation or emergency operation plans, but not all of them provide organizational alternatives in the event of disruption of the normal movement of staff, patients, equipment, and supplies that characterizes everyday hospital operations. The critical nature and interdependence of these processes represent a separate category of vulnerabilities that need careful attention. Spatial distribution of hospital functions and their inter-relationship determines the extent hospital operations are affected when normal movement and communication of people, materials, and waste are disrupted. The disruption by natural hazard events of administrative services such as contracting, procurement, maintenance, as well as allocation of resources, can impair hospital functions almost as much as any physical damage.

Just-in-time delivery: Many hospitals have currently eliminated, or greatly reduced, onsite storage for linen, supplies, food, and other materials essential to normal operations. Any prolonged isolation or blockage of streets serving the hospital could lead to a need to ration supplies and triage patients for treatment, due to the limited supplies stored on site. During Hurricane Katrina, many hospitals were isolated by floodwaters for 5 or more days and, in many cases, could not replenish critical supplies, which in some instances contributed to the decision to evacuate the facility.

Evacuation: Evacuation of patients is a measure of last resort, but occasionally necessary, especially in extreme situations. Many different conditions or vulnerabilities mentioned above can cause the evacuation of a hospital, but the process of evacuation itself can also be vulnerable to disruption that can seriously aggravate the health and safety of patients. Frequently, a flood, earthquake, or a windstorm can cause blockage of access roads, cutting off a hospital from normal evacuation routes, as happened during Hurricane Katrina. Surface escape routes were under water and unusable, and even air evacuation was impaired because many ground level helicopter landing pads were under water. Elevated helipads located on roof tops or elevated parking structures proved invaluable features in this type of an emergency. The spatial relationship to the hospital building was another aspect that greatly influenced the evacuation and reduced the risk of aggravating patients' condition. Helipads physically connected to the hospital were most useful, because patients could be transported directly and very rapidly from the upper levels of the hospital to the helipad without interference from other hospital functions.

1.4 HOSPITAL DESIGN AND CONSTRUCTION

Permanent high occupancy and the need for uninterrupted operation are the most important characteristics of hospital facilities. They determine most of the building design requirements and pose the greatest challenge in the design of mitigation measures. Contemporary hospitals must accommodate both critically ill patients and a high volume of ambulatory patients. Length of stay for inpatients may be as short as one day, but usually averages around 5 to 6 days in most hospitals. Acute care patients often have visitors on a daily basis, while emergency departments are routinely crowded with patients and their families, particularly at peak times during the day.

It is not uncommon that some building designs that are otherwise suitable for the complex requirements of hospital operations can impair these operations in emergency conditions. This is particularly true of many older hospitals that were not designed to maintain their performance level in all conditions. Older emergency departments are generally not large enough and are often overcrowded. Many of the older hospitals would not have been designed to adjust their operations and their physical space to the conditions of mass post-disaster care.

Similarly, larger hospitals typically have greater flexibility to cope with the emergencies and large numbers of casualties than smaller hospitals. This, however, can be a liability, especially in dense urban areas where hospital buildings are frequently 10 or more stories high. Large, tall hospital buildings, with greater than usual floor-to-floor height, are almost completely dependent on elevators for vertical communication, which exposes them to serious disruption in case of electrical or mechanical failures common during hazard events. Such difficulties are further compounded if an evacuation is necessary. When the elevators are rendered inoperable, the patients must be carried up or down long stairwells, which can be an overwhelming task for the staff of any large hospital.

Since the development of effective ventilation systems, most hospitals were designed as “thick” buildings, where many areas do not have natural light and depend on mechanical ventilation to be usable. Generally, the larger the hospital, the more functions and areas depend on mechanical ventilation and artificial light. This is another important aspect of hospital vulnerability in situations where normal power supply is disrupted. Hospital closures and evacuations caused by nonfunctioning air-conditioning systems in the wake of Hurricane Katrina stand as stark examples of the need to protect these systems much more effectively.

Hospitals usually do not occupy just one building. In most cases a hospital is located on campus that comprises a number of different buildings, each housing a separate function. In addition to an acute care hospital, which might be composed of several wings of varying ages, there might also be a separate power plant, medical office building, ambulatory surgery and procedures building, behavioral health building, fitness center, dialysis center, or cancer center. Since all of these buildings have a different type and level of occupancy, from the perspective of patient safety and that of uninterrupted hospital operations, they do not need the same level of disaster-resistant construction.

1.4.1 BUILDING CODES

Most States have adopted one of the model building codes, frequently with modifications and local additions. Building codes address minimum requirements for building resistance to major hazards based on historical experience. Recent disaster experience, however, indicates that current code requirements are not always adequate, especially not for essential facilities such as hospitals. To make things worse, many existing hospitals were built to older codes that frequently did not have any provisions for protection against natural hazards.

Most essential facilities require special attention, in addition to compliance with building code requirements, in order to be able to sustain their operations after a major disaster. Some States, like Florida or California, for example, have amended their codes to address the need for adequate protection of hospitals and other critical facilities from prevailing local hazards. California has adopted legislation for seismic design based on the principle that hospitals should be able to function at least at a basic level after an earthquake of moderate to large magnitude. This new standard has resulted in the closure of many hospitals that could not comply with the new requirements in a cost-effective manner. The implementation of this standard was significant because it established the new criterion for post-disaster functionality that should serve as a model for hazard-prone regions. This and similar standards have expanded the narrow, prescrip-

tive nature of most building codes, by defining the performance goals that hospitals must achieve. This Design Guide fully supports the trend toward performance-based codes for design and construction of hospitals.

In addition to local building codes, various organizations and agencies, like the U.S. Department of Veterans Affairs (VA), have developed their internal building design and construction regulations to address the three major hazards: flood, wind and earthquake. The VA standard “*Natural Disasters Non-Structural Resistive Design (formerly CD-54)*” together with this publication, is a valuable resource for information on new hospital construction and renovation of existing hospitals.

1.5 MULTI-HAZARD DESIGN CONSIDERATIONS

A comprehensive hazard risk reduction design strategy that considers all the risks to which a facility may be subject is an evolving concept that is still in its infancy. Multi-hazard design is an approach that aims to integrate risk reduction with the building design process, rather than pursuing a traditional tendency towards fragmented risk reduction efforts.

Chapters 2, 3, and 4 outline the characteristics of the three natural hazards that are the subject of this publication, in terms of their geographical locations, intensity, and frequency. In addition, methods used to mitigate the risks and issues relating to building codes and regulations are also discussed. However, each hazard is discussed separately, without reference to the others. Many building locations are vulnerable to more than one hazard, requiring the application of appropriate design solutions that would mitigate each relevant hazard.

This section looks at the interaction between various building design features and mitigation measures used to protect buildings against specific hazards, by comparing their effects for each individual hazard. The similarities and differences in the ways that hazards affect buildings, and how to guard against them, demand an integrated approach to building design that would be resistant to natural hazards. This, in turn, must be pursued as part of a larger, integrated approach to the whole building design process.

Of the many hazards that can endanger a hospital and impair the services it provides to a community, fire is the most prevalent. Every hospital is at risk from fire, which makes this hazard much more pervasive than any of the natural hazards noted above. However, fire protection measures have been present in building codes for a long time, in the form of approved materials, fire-resistant assemblies, exiting requirements, the minimum number and capacity of emergency exit routes, and many other specifications. For that reason, fire hazards are not addressed in this publication as

a stand-alone hazard. However, the mitigation measures used to protect the buildings against high winds, floods, and earthquakes may interact favorably or unfavorably with the need for fire protection. For this reason, fire is included as a hazard in the table of system interactions at the end of this chapter.

1.5.1 THE NEED FOR A MULTI-HAZARD APPROACH

The need to embrace a multi-hazard approach when designing or retrofitting a hospital is essential for their protection, especially when they are located in areas that are exposed to a variety of natural and man-made hazards. A multi-hazard approach can help identify potentially conflicting effects of certain mitigation measures and help to avoid aggravating the vulnerability of many hospital building components and systems. A comprehensive evaluation and application of hazard mitigation in building design serves to improve the overall effectiveness of mitigation measures that protect the continuity of hospital functions and operations. The importance of this practice has become increasingly evident following the catastrophic disasters that have occurred in the recent past.

The aim should be to anticipate and coordinate how the building and its systems interact, how mitigation of the risk from one hazard can influence the building's vulnerability to others, and how undesirable conditions and conflicts may be avoided or resolved. Through the application of a multi-hazard and multi-disciplinary approach, cost savings, efficiency, and better performance can be achieved in programming and planning new buildings and retrofitting existing ones.

A multi-hazard risk reduction approach requires a multidisciplinary design team. This ensures that the project design benefits from an appropriate professional expertise and a thorough discussion of project issues from start to finish.

The design team should be able to take an all-hazard viewpoint, and understand how the structure and systems interact under extreme conditions imposed by natural hazards. Thus, an important aspect of multi-hazard design should be to investigate the extent to which the methods used for mitigation of one hazard may reinforce or conflict with design elements necessary for protection against other possible hazards. When the design methods reinforce one another, the costs of multi-hazard design may be reduced and the performance improved, but where they conflict, costs may be increased in order to satisfy the requirements for resistance to all relevant hazards.

1.5.2 MULTI-HAZARD DESIGN MATRIX

The Multi-hazard Design System Interaction Matrix highlights the interaction between a particular hazard and a building design component or system. Table 1-1 presents this system interaction matrix in a graphic form by adding small illustrations for each site or building characteristic listed. For each entry the matrix provides a description; a sample illustration; positive, negative, or neutral characterization of the interaction; and an explanation of the nature of interaction.

The explanations are general statements intended more to provoke thought and further analysis towards design integration, rather than to provide definite restrictions or recommendations. It is possible to overcome conflicts by sound, coordinated design between the consultants, starting at the inception of design. General cautions, such as the relationship between building weight and seismic forces, for example, are intended only as reminders of basic physical facts.

In order to facilitate comparison between hazards, the following convention has been used in Table 1-1.

✓	Indicates a desirable condition or beneficial interaction between the designated component/system and a given hazard
✗	Indicates an undesirable condition or the increased vulnerability of a designated component/system to a given hazard
0	Indicates little or no significant interaction between the designated component/system and a given hazard

Table 1-1: Multi-hazard Design Matrix

System ID	Site and Building Characteristics	Examples of Site and Building Characteristics	THE HAZARDS				Explanation of Interaction
			Seismic	Flood	Wind	Fire	
1	SITE						
1A	Site-specific and building specific all-hazard analysis.		✓	✓	✓	✓	Beneficial for all hazards.
1B	Two or more means of access to the site		✓	✓	✓	✓	Beneficial for all hazards.
1C	Site modification to elevate building on engineered fill.		✗	✓	0	0	Highly beneficial for flood, needs very careful site engineering for earthquakes. Not significant for fire. Probably not significant for wind but depends on topography.
2	ARCHITECTURAL						
2A	CONFIGURATION						
	2A-1 Re-entrant corner plan forms		✗	0	✗	0	May cause stress concentrations and torsional forces in earthquakes, and contribute to localized high-wind pressures.
	2A-2 Enclosed courtyard plan forms		✗	0	0	0	May cause stress concentrations and torsional forces in earthquakes.

Table 1-1: Multi-hazard Design Matrix (continued)



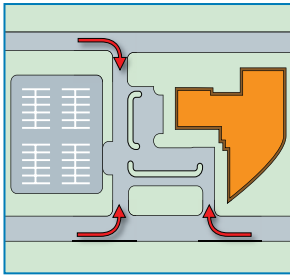
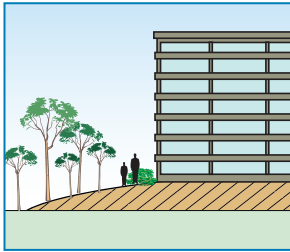
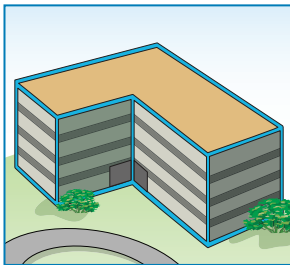
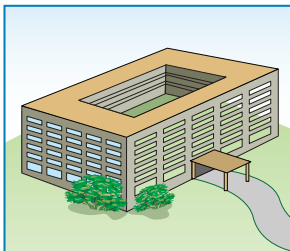

System ID	Site and Building Characteristics	Examples of Site and Building Characteristics	THE HAZARDS				Explanation of Interaction
			Seismic	Flood	Wind	Fire	
2	ARCHITECTURAL (continued)						
2A	CONFIGURATION (continued)						
	2A-3 Very irregular three-dimensional building forms		x	0	x	x	May create indirect load paths, stress concentrations, and torsional forces in earthquakes. May contribute to localized high wind pressures, and aggravate evacuation during fire emergencies.
	2A-4 Large roof overhangs		x	0	x	0	Vulnerable to vertical earthquake and wind forces, needs careful engineering.
2B	CEILINGS						
	2B-1 Hung ceilings		✓	0	0	✓	If properly attached to structural components using diagonal braces, reduce damage from earthquakes.
2C	PARTITIONS						
	2C-1 Unreinforced CMU or hollow clay tile, used as partitions or infill between structural framing		x	x	x	✓	High vulnerability to seismic and wind forces, but desirable against fire if not in seismic zone. If exposed, vulnerable to flood forces.

Table 1-1: Multi-hazard Design Matrix (continued)

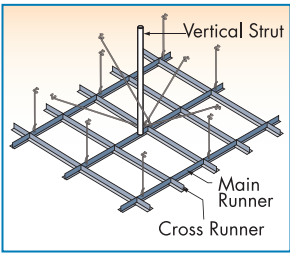

System ID	Site and Building Characteristics	Examples of Site and Building Characteristics	THE HAZARDS				Explanation of Interaction
			Seismic	Flood	Wind	Fire	
2	ARCHITECTURAL (continued)						
2C	PARTITIONS (continued)						
	2C-2 Non-rigid (ductile) connections for attachment of interior non-load-bearing walls to structures including extra-high and -heavy gypsum board walls		✓	0	0	✗	Beneficial for earthquakes but gaps between components may threaten fire resistance. Not significant for flood and wind.
	2C-3 Gypsum wall board partitions		✓	✗	0	✓	Gypsum partitions properly braced to structure beneficial in seismic zones. Susceptible to flood damage, but good for fire if proper resistance is specified. Not significant for wind.
2D	OTHER ELEMENTS						
	2D-1 Tile roofs		✗	0	✗	✓	Undesirable in seismic zones unless properly attached. On light structures, may cause poor seismic response. Good fire protection against external fire (wildfires) but undesirable in hurricane- and tornado-prone regions.
	2D-2 Parapets		✓	0	0	✓	Properly engineered parapet beneficial in seismic zones, but unbraced URM very dangerous in earthquake and wind. High parapets (>3 ft.) beneficial for wind. May assist in reducing fire spread to adjacent buildings.

Table 1-1: Multi-hazard Design Matrix (continued)



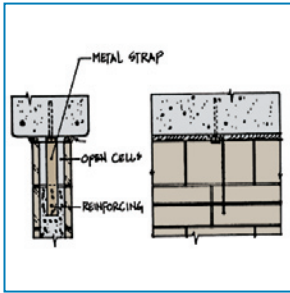
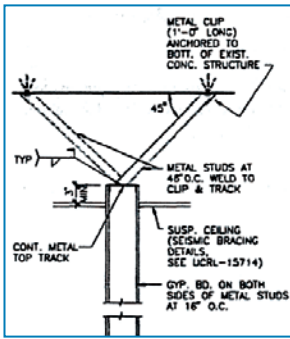

System ID	Site and Building Characteristics	Examples of Site and Building Characteristics	THE HAZARDS				Explanation of Interaction
			Seismic	Flood	Wind	Fire	
3	STRUCTURAL SYSTEM						
	3-1 Base isolation and/or energy dissipating dampers		✓	✗	0	0	Beneficial for earthquake, but base isolation in basement should be dry floodproofed to reduce vulnerability to flood damage. Not significant for wind and fire.
	3-2 Wood frame structure, used for small hospitals and ancillary and service buildings		✓	✗	0	0	Light weight beneficial in seismic zones provided adequate connections and shear walls are used. Lightness and lack of moisture resistance a disadvantage in floods.
	3-3 Heavy structure with concrete floors, reinforced concrete moment frame, or frame with reinforced concrete or masonry shear walls.		✓	✓	✓	✓	Although weight increases seismic forces it is not a design problem. Requires special non-ductile detailing for large building frames. Generally beneficial for all other hazards.
	3-4 Reinforced concrete or reinforced CMU structural walls with concrete floors and roof deck		✓	✓	✓	✓	Very beneficial for wind, good performance for earthquake, flood, and fire when correctly designed and constructed.
	3-5 Steel structural frame		✓	✓	✓	✗	Lighter than concrete, needs properly detailed moment frame, steel braces, or shear walls in seismic and high-wind zones. Good in flood with proper detailing, especially for elevated structure. Vulnerable to fire.

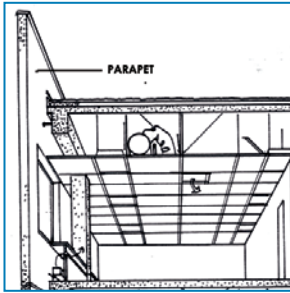
Table 1-1: Multi-hazard Design Matrix (continued)



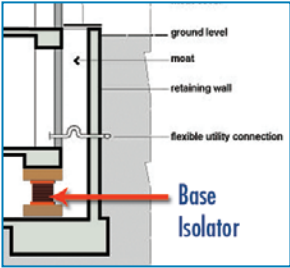

System ID	Site and Building Characteristics	Examples of Site and Building Characteristics	THE HAZARDS				Explanation of Interaction
			Seismic	Flood	Wind	Fire	
3 STRUCTURAL SYSTEM (continued)							
	3-6 Unreinforced masonry load-bearing walls		x	x	x	0	Very poor performance in earthquakes and high winds. Undesirable for all hazards because of possibility of collapse.
	3-7 Steel or concrete frame structure with open first floor		0	✓	0	0	Very beneficial for flood. Requires careful design for earthquake, wind, and fire.
	3-8 Indirect vertical load path	 Discontinuity at third floor	x	0	x	x	Undesirable for seismic and wind hazards because poor structural integrity increases likelihood of collapse. Fire may further weaken structure.
	3-9 Large seismic separation joints in structure		✓	0	x	x	Improves seismic response, but creates possible path for toxic gases during fire. (Cause of deaths in Las Vegas MGM Grand fire.) Needs careful protection against wind-driven rain.
	3-10 Ductile detailing of steel and RC structure and connections		✓	0	✓	0	Provides better nonlinear response and a structure that is more resistant to collapse.

Table 1-1: Multi-hazard Design Matrix (continued)

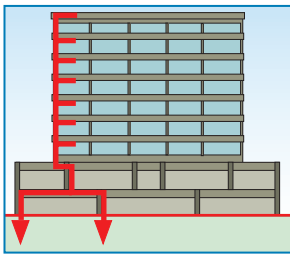

System ID	Site and Building Characteristics	Examples of Site and Building Characteristics	THE HAZARDS				Explanation of Interaction
			Seismic	Flood	Wind	Fire	
3 STRUCTURAL SYSTEM (continued)							
	3-11 Reinforced concrete or reinforced CMU around exit ways and exit stairs		✘	0	✔	✔	<p>Properly designed, will preserve evacuation routes in event of fire.</p> <p>May create torsional response and stress concentrations in earthquakes unless isolated. If fully encloses staircases beneficial as wind shelter.</p>
4 BUILDING ENVELOPE							
4A EXTERIOR WALL CLADDING							
	4A-1 Brick veneer on exterior walls		✘	✘	✘	0	In earthquakes, winds, and floods material may detach and cause costly damage and injury. Careful detailing and quality control necessary for good performance.
	4A-2 Lightweight insulated cladding and EIFS		✔	0	✘	0	Light weight reduces structural response in earthquakes, but needs very careful engineering and application to prevent leakage and detachment in winds. Vulnerable to windborne debris impact. Not significant in floods or fire.
	4A-3 Precast concrete panels		✘	0	✔	0	<p>Requires special detailing with ductile connections to structure in high seismic zones.</p> <p>Good for winds if well attached and joints are protected against wind-driven rain.</p>

Table 1-1: Multi-hazard Design Matrix (continued)

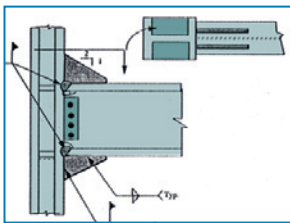

System ID	Site and Building Characteristics	Examples of Site and Building Characteristics	THE HAZARDS				Explanation of Interaction
			Seismic	Flood	Wind	Fire	
4	BUILDING ENVELOPE (continued)						
4B	GLAZING						
	4B-1 Metal/glass curtain wall		✓	0	✗	✗	Light weight reduces seismic forces, but needs special design and installation to prevent failure in earthquakes. Fire can spread upward behind curtain wall if not properly fireproofed. Vulnerable to windborne debris.
	4B-2 Impact-resistant glazing		0	0	✓	✗	Can cause problems during fire rescue operations, limiting smoke ventilation and access. Good against wind-borne debris but not significant for earthquake or flood.
5	UTILITIES						
	5-1 Anchorage/ bracing of system components	 Chiller Support	✓	✓	✓	0	Essential for earthquake and wind (especially exterior mounted), beneficial for flood, not significant for fire.
	5-2 Location of system components above flood level		✗	✓	0	0	Very beneficial for flood, if in upper floors may be subject to greater forces in earthquake, not significant for wind or fire.

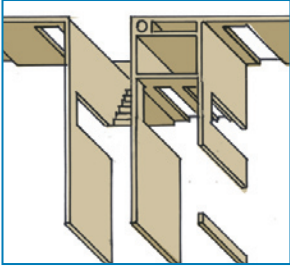
Table 1-1: Multi-hazard Design Matrix (continued)

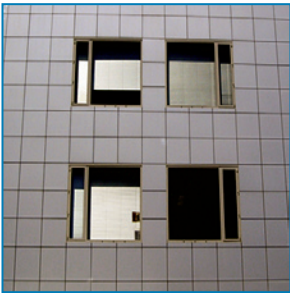
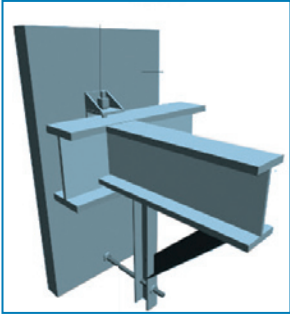

System ID	Site and Building Characteristics	Examples of Site and Building Characteristics	THE HAZARDS				Explanation of Interaction
			Seismic	Flood	Wind	Fire	
6 MECHANICAL							
6-1	Anchorage/bracing of system components		✓	✓	✓	0	Essential for earthquake and wind (exterior-mounted), beneficial for flood.
6-2	Vibration-isolated equipment designed for seismic and wind forces: snubbers prevent equipment from falling off isolators	 Isolators with "snubbers" and provisions for wind uplift	✓	0	0	0	Very beneficial for earthquake, not significant for flood or fire. If not designed to resist uplift inadequate for wind.
6-3	Anchorage of rooftop equipment		✓	0	✓	0	Very beneficial for wind and earthquake (with seismic designed isolators where necessary), not significant for floods and fire.
7 PLUMBING							
7-1	Anchorage/bracing of system components	 Pipe Support	✓	0	✓	✓	Essential for earthquake and wind (for exterior-mounted systems), beneficial for fire.

Table 1-1: Multi-hazard Design Matrix (continued)

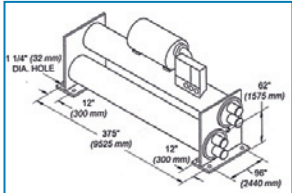
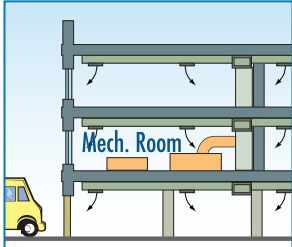
System ID	Site and Building Characteristics	Examples of Site and Building Characteristics	THE HAZARDS				Explanation of Interaction
			Seismic	Flood	Wind	Fire	
8 ELECTRICAL AND COMMUNICATIONS SYSTEM							
	8-1 Anchorage/ bracing of system components	 <p>Unbraced electrical cabinets</p>	✓	0	✓	✓	Essential for earthquake and wind (for exterior-mounted systems), beneficial for fire.
	8-2 Emergency power supply adequate for essential services and equipment securely braced	 <p>Braced emergency batteries</p>	✓	✓	✓	✓	Essential for seismic, flood, wind, and fire.

1.6 REFERENCES

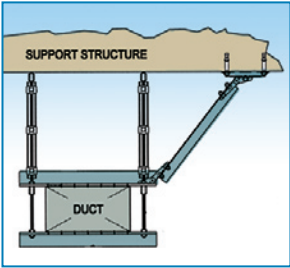
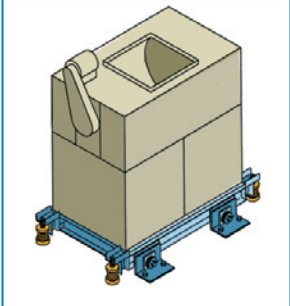
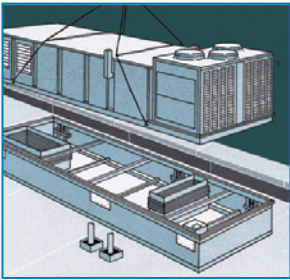
S. A. Lister, “*Hurricane Katrina: The Public Health and Medical Response*,” Congressional Research Service, 21 September 2005.

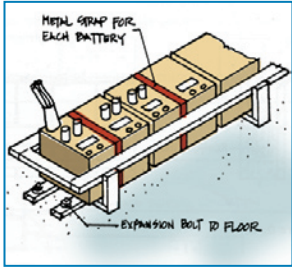
US Department of Energy (DOE). 2002. *Buildings for the 21st Century*. Office of Building Technology, State and Community Programs Newsletter. Washington, DC. DOE/GO-102002-1518. Winter 2002.

World Health Organization. 2006. *Health Facility Seismic Vulnerability Evaluation*. World Health Organization Regional Office of Europe, Copenhagen, Denmark.

2.1 INTRODUCTION

This chapter examines potential earthquake damage to hospitals and how these facilities can most efficiently improve their expected performance. An explanation of the nature and probability of earthquakes is provided, together with procedures for determining the approximate earthquake threat to specific locations. Typical seismic damages and the possible resulting effects on building function or risk to occupants are described and related to standard damage states currently used in performance-based earthquake engineering design.

The enhanced performance normally expected from hospitals is discussed, specifically as it relates to protection of inpatients and provision of care for the injured and other outpatients. Since many older buildings may not have been designed for seismic forces, particularly for enhanced performance, estimation of the actual expected performance is critical for adequate emergency planning.

The case studies in this chapter illustrate the performance of hospital buildings in earthquakes, and look at the enhancements made in the existing seismic protection of the structural and nonstructural systems to improve performance. The chapter ends with a review of best practices in seismic design and seismic retrofit of hospital facilities.

2.1.1 THE NATURE AND PROBABILITY OF EARTHQUAKES

Although earthquakes cannot be prevented, modern science and engineering provide tools that can be used to reduce their effects.

Firstly, science can now identify where earthquakes are likely to occur, at what magnitude, and determine the relative likelihood of a range of ground shaking levels. This information is readily available to architects, engineers, code writers, planners, and to the general public. Secondly, seismic researchers and structural engineers with experience in seismic design have sufficient understanding of the effects of earthquake shaking on buildings to create designs that will be safe for various intensities of shaking. Modern building codes incorporate all of this information and require buildings to have seismic designs appropriate for each region.

However, earthquakes are complex phenomena, and the exact nature of ground shaking, and a building's response to that shaking, are still shrouded in considerable uncertainty. The primary intent of the seismic provisions of building codes is to provide buildings that will be safe in the expected earthquake. Current buildings designed to modern codes are extremely unlikely to sustain serious structural damage or partial collapse in a design earthquake. However, subtle changes in shaking from site to site, the wide range of building types and configurations, and the variation in skill and thoroughness with which any one building is designed and constructed can result in a wide range of damage levels in any given earthquake. Perhaps more importantly, many older hospital buildings were designed and built without seismic design features, or at best outdated ones. These buildings cannot be expected to perform well enough to serve their intended roles after an earthquake event. Lastly, it is now well known that the nonstructural systems of essential buildings are extremely important in maintaining post-earthquake functionality. Until very recently these systems, in general, have not been designed and installed with adequate seismic protection.

2.1.2 EARTHQUAKE EFFECTS

Fractures and movements within the earth's crust generate earthquake ground motion by sending waves through the rocks and soil outward from the source. Most commonly, these sources are known faults, defined as cracks or weakened planes in the earth's crust most likely to "break" as a result of global tectonic movements. The propagation of the waves through the crust produces movement of the earth's surface. Any one location on the surface will move in every direction simultaneously, back and forth, side to side, and up and down, creating the shaking effect that is both strange and frightening. The shaking effect, or *seismic ground motion*, is felt in all directions from the *epicenter*—the location where the fracture started—and diminishes with distance from the epicenter. Buildings, bridges, transmission towers, and other structures supported by, and attached to, the ground will also be shaken. If the intensity of shaking is high, most structures will sustain some damage. The criteria used to de-

termine the capacity of the ground motion to inflict damage on the built environment are somewhat intuitive: large displacements of the ground (3 feet versus 3 inches), rapid changes in the movement (measured in units of *acceleration*), or the duration of shaking.

Although seismic ground motion is most often identified with earthquakes, it is not the only phenomenon that causes damage. Earthquakes involve movements of large portions of the earth's crust, and the resulting shaking can produce other geologic hazards:

Surface Fault Rupture affects a small strip at the ground when the movement on a fault deep within the earth breaks through to the surface. The relative displacement of the ground on each side of the rupture may be several feet or more, and structures straddling this zone are likely to be severely damaged.

Liquefaction occurs when the behavior of loose granular soils and sand in the presence of water changes temporarily from that of a solid to that of a liquid material when subjected to ground shaking. This condition occurs mainly at sites located near rivers, lakes, and bays.

Landslides occur when the top layers of soil and rock slip on sloping ground, triggered by earthquake ground motion.

Tsunamis are earthquake-caused wave movements in the ocean that travel at high speed and may result in large coastal waves of 30 feet or more. They are sometimes, and incorrectly, called tidal waves.

Seiches are waves similar to tsunamis. They can be triggered by earthquakes and generated by sloshing in closed lakes or bays; they have the potential to cause serious damage, although such occurrences are very rare.

2.1.3 MEASURING EARTHQUAKE EFFECTS

Earthquakes vary in many respects, but the resulting shaking depends mainly on the magnitude of the earthquake and the distance from the epicenter. The potential risk to manmade structures is determined on the basis of frequency of occurrence of earthquakes at a given site, and measurements of a number of physical characteristics of ground shaking. The following section discusses the measurements used for this purpose, and their role as damage parameters.

Perhaps the most familiar measure of earthquakes is the Richter Magnitude, devised by Professor Charles Richter of the California Institute of Technology in 1935. Richter's scale is based on the maximum ampli-

tude of certain seismic waves recorded on a standard seismograph at a distance of 100 kilometers (km) from the earthquake epicenter. Because the instruments are unlikely to be exactly 100 km from the source, Richter devised a method to allow for the diminishing of wave amplitude with increased distance. The Richter scale is logarithmic, and each unit of magnitude indicates a ten-fold increase in wave amplitude. The energy level is multiplied approximately by 31 for a unit increase in Richter magnitude scale. The scale is open-ended, but a magnitude of about 9.5 represents the largest earthquake scientists now expect within the current understanding of movement in the earth's crust.

Among scientists, Richter Magnitude has been replaced by Moment Magnitude, a similar measure of energy that is based on the physical characteristics of the fault rupture, which is a more useful measure for large events. The Moment Magnitude scale has been set to produce values similar to the Richter scale, and for damaging earthquakes, values are normally in the 5.5 to 8.0 range, although magnitudes over 9.0 also occur.

The level of damage is often measured by intensity scales, and the most common scale used in the United States is the Modified Mercalli Intensity (MMI) scale, reported in Roman Numerals from I to XII. MMI is often incorrectly used to measure the size of an earthquake. In fact, the MMI is assigned to small areas, like zip codes, based on the local damage to structures or movements of soil. Many MMIs can be associated with a single earthquake because the shaking, and therefore the damage, diminishes as the distance to the epicenter increases. Although the MMI is useful for the purpose of comparing damage from one event to another (particularly events for which little or no instrumental measurements are available), it is very subjective, and scientists and engineers prefer instrumental measurements of the ground shaking to measure intensity.

It is important to understand that magnitude is not a measure of damage, but a physical characteristic of an earthquake. An earthquake with magnitude 6.7 that occurs in a remote area may cause no damage to manmade structures, but one with the same magnitude can cause considerable damage if it occurs close to an urban area.

Scientists and engineers need measures of the damaging characteristics of earthquakes to compare the inherent risk at different locations, and to develop design solutions to limit damage to acceptable levels. The universal characteristic of earthquakes, and the one that can be measured most precisely, is the ground motion. Extensive networks of instruments are now employed on the ground and in manmade structures to record continuously the motions during an earthquake. The ever-growing database of earthquake recordings can be analyzed in various ways to develop appropriate measures of intensity that best predict potential damage to buildings and other structures, and the possibility of liquefaction and landslides. Tsunamis and seiches are normally not caused by the traveling

seismic waves, but by large, single movements of land under water as part of the fault movement or resulting large landslides.

2.1.3.1 Measuring Seismic Ground Motion

Acceleration is a measure of velocity changes over time, and is commonly experienced when our heads snap back when a car starts off rapidly. Similarly, acceleration causes a building to “snap back” as a result of sudden large ground movement. This movement within the building or other structure, which becomes very complex when caused by 20 seconds or more of ongoing, rapidly changing accelerations, is what causes direct shaking damage. Consequently, it is common to describe earthquake motion using the largest acceleration that occurred during the event, or *peak ground acceleration* (PGA).

Although PGA is useful as a simple way to measure and compare ground motions, it is not the most comprehensive one. From studies of ground motions and structural responses to ground motions, engineers and researchers have developed parameters that consider the characteristics of the entire motion, rather than the one instant when the PGA occurs. This characterization of the ground motion is called a *response spectrum* and measures the extent of shaking different structures will experience, based on their natural period of vibration, when subjected to a given ground motion (see section 2.2.2.1). The maximum response to a specific ground motion of a structure with a given period is called the *spectral ordinate*. The full response spectrum simply represents the suite of spectral ordinates for a wide range of structures—from periods of about 0.2 seconds (short, very stiff buildings) to periods of about 4.0 seconds (tall, very flexible buildings).

Response spectra can be calculated for the entire database of recorded ground motions, and trends analyzed. For example, it has been determined that the response spectrum for most earthquake shaking has a similar shape, and that this shape has subtle changes based on the soil on which it was recorded. Figure 2-1 shows the typical shape of earthquake ground motion spectra and the variations that will be caused, on average, by different site soils. Like PGA, higher spectral ordinates typically mean more intense and potentially damaging motions. By studying the location of potential earthquake sources and the probability of them generating an earthquake in any given time period, scientists can develop a response spectrum for earthquake shaking likely to occur at that site. This has been done by the U.S. Geological Survey (USGS) for the entire United States, and is the basis for seismic design requirements in building codes. This information is presented on maps. For simplicity, only two spectral ordinates are mapped, for periods of 0.2 second and 1.0 second. Exam-

ples of these maps are shown in Figure 2-2. Rules in the building codes allow engineers to calculate the appropriate spectral ordinate for all periods, as shown in Figure 2-1, based on the mapped values. Site classes in the figure are also defined in the building codes, Class A being hard rock, and Class E being a very soft site with potential soil failure.

Figure 2-1:
Representative shapes of building code (or design) response spectra for different soils

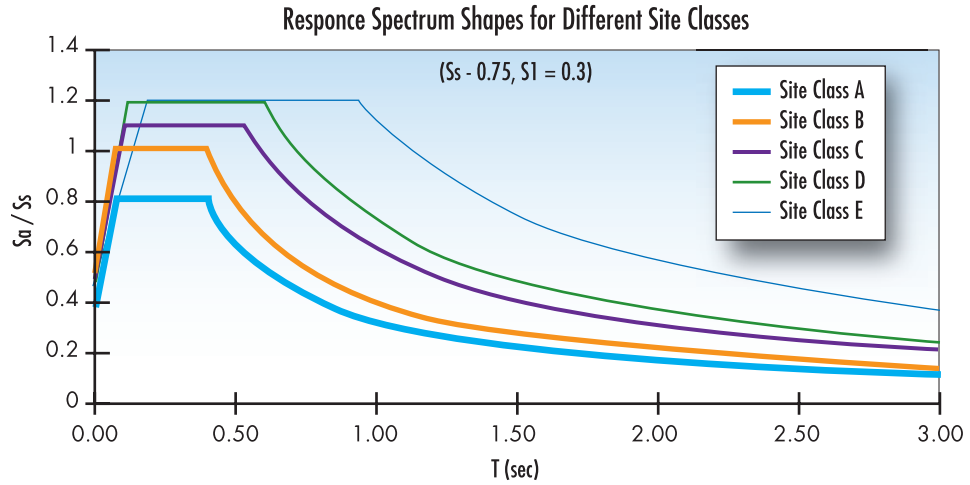

1.0 sec Spectral Acceleration (%g) with 2% Probability of Exceedance in 50 Years

site: NEHRP B-C boundary

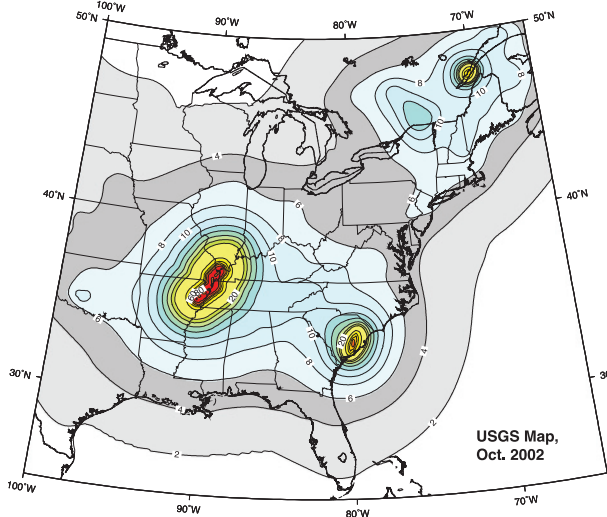

0.2 sec Spectral Acceleration (%g) with 2% Probability of Exceedance in 50 Years

site: NEHRP B-C boundary

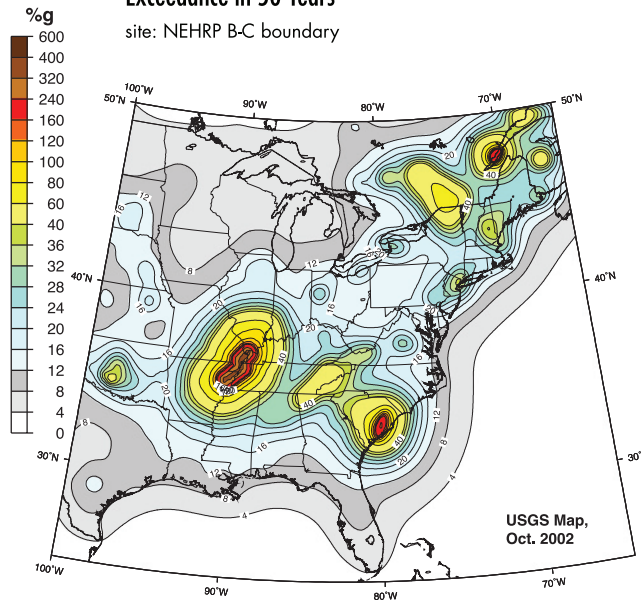

Figure 2-2: Example of national seismic hazard maps

2.1.3.2 Measuring Potential for Liquefaction

Soils that are loose, not well graded, and saturated with water are prone to liquefaction. These conditions often occur near waterways, but not always. In addition to the soil type, the probability of liquefaction also depends on the depth from the surface to the layer, and the intensity of ground motion. Further, the results of liquefaction can vary from a small, uniform settlement across a site, to loss of foundation bearing, resulting in extreme settlement and horizontal movement of tens of feet (called lateral spreading). Lastly, the risk of liquefaction is directly dependent on the earthquake risk. Due to this complex set of conditions, damage potential from liquefaction is difficult to map. For all but the smallest projects, many building jurisdictions in seismic areas require identification of liquefaction potential in the geotechnical report, particularly in areas of known potential vulnerability. On sites where liquefaction is more than a remote possibility, the likely results of liquefaction at the ground surface or at the building foundations will also be estimated. Small settlements may be tolerated without mitigation. Larger potential settlements can be prevented by site remediation measures, if economically justified. In some cases of potential massive liquefaction and lateral spreading, using the site for structures may not be cost effective. Officials in some regions of high seismicity have developed maps of local areas that are potentially susceptible to liquefaction and require site-specific investigation.

2.1.3.3 Measuring Potential for Landslide

The shaking from earthquakes can also cause landslides, depending on the slope, type, and configuration of soil stratum. Landslides can cause damage to improvements built within the slide area or near the top of the slide, ranging from complete destruction to distortion from relatively small vertical or lateral movements. Sites can also be threatened by landslides occurring uphill, sometimes completely offsite and quite a distance away. Similar to liquefaction, accurate probability of land sliding is difficult to map on a regional or national scale, and this threat is normally identified in site-specific geologic hazard studies. Also similar to liquefaction, the largest portion of the risk may be a triggering event. In some cases, it is possible and cost effective to stabilize small areas at risk of potential landslides. Stabilizing larger areas at risk of landslides may not be feasible. Some regions of high seismicity have developed maps of the areas susceptible to landslides based on average slopes, geologic soil types, and the past history of sliding. Sites within these susceptible zones require site-specific investigation.

2.1.3.4 Measuring Potential for Tsunami and Seiche

Researchers have studied tsunamis and seiches for many years, but the tragic tsunami in the Indian Ocean in December 2004 highlighted the need for better measurement of the threat in terms of magnitude and location. Obviously, only sites near large bodies of water are susceptible, and normally at elevations 50 feet or less above the water surface, although bays and narrow canyons can amplify the wave height. Although similar to storm surge, the height and the potential velocity of a tsunami wave represent a separate risk and must be mapped separately. In addition to dependence on local conditions, quantification of the risk from tsunamis and seiches is made more difficult because not every earthquake generates such a wave. Studies are required that consider the individual characteristics of the site and the facility, to establish the risk and identify possible mitigating measures.

2.1.4 EARTHQUAKES: A NATIONAL PROBLEM

Most people now know that although most frequent in California and Alaska, earthquakes are not restricted to just a few areas in the United States. In fact, two of the greatest earthquakes in U.S. history occurred not

The U.S. Congress recognized earthquakes as a national problem by passing legislation authorizing the National Earthquake Hazards Reduction Program (NEHRP) in 1977. NEHRP has since supported numerous research and hazard mitigation efforts.

in California, but near New Madrid, MO, in 1811 and 1812. In the International Building Code (IBC), the most common model building code in use in the United States and its territories, buildings on sites with a low enough seismic risk that specific design for seismic forces is not required are classified as Seismic Design Category (SDC) A. As shown in Figure 2-3, 37 of 50 States have regions with sufficient seismic risk to require designs more stringent than SDC A. The likelihood of a damaging

earthquake occurring west of the Rocky Mountains—and particularly in California, Alaska, Oregon, Washington, and Utah—is much greater than it is in the East, Midwest, or South. However, the New Madrid and Charleston, SC, regions are subject to potentially more severe earthquakes, although with a lower probability, than most regions of the western United States. According to the IBC design maps and the USGS hazard maps upon which they are based, other locations should also plan for intermediate ground motions.

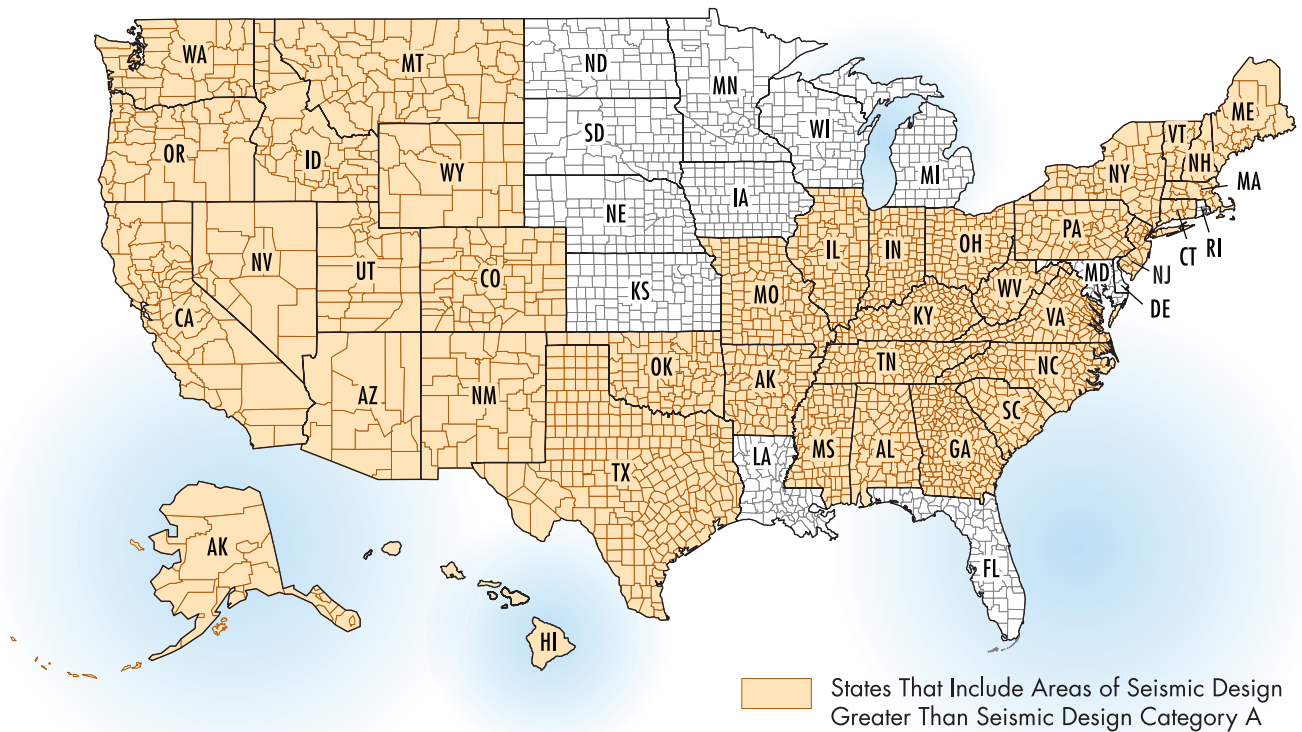

Figure 2-3: States with seismic risk

Records show that some seismic zones in the United States experience potentially damaging earthquakes approximately every 50 to 70 years, while other areas have “recurrence intervals” for the same size earthquake of about 200 to 400 years. These frequencies of occurrence are simply statistical probabilities, and one or several earthquakes could occur in a much shorter than average period. With current knowledge, there is no practical alternative for those responsible for healthcare facilities located in earthquake-prone regions but to assume that the design earthquake, specified in the building code for the local area, could occur at any time, and that appropriate planning for that event should be undertaken.

Moderate and even very large earthquakes are inevitable, although very infrequent, in some areas of normally low seismicity. Consequently, in these regions, most buildings in the past were not designed to deal with an earthquake threat; they are extremely vulnerable. In other places, however, the earthquake threat is quite familiar. Medical facilities in many areas of California and Alaska will be shaken by an earthquake, perhaps two or three times a year, and some level of “earthquake-resistant” design has been accepted as a way of life since the early 20th century.

Nationally, the areas where earthquakes are likely to occur have been identified, and scientists have a broad statistical knowledge of the po-

tential magnitude of these earthquakes and the likelihood of their occurrence. However, it is not yet possible to predict the near-term occurrence of a damaging earthquake. Therefore, it makes sense to take the minimum precautionary measures and conform to local seismic building code requirements for new buildings. U.S. seismic building code provisions focus on requiring the minimum measures necessary to prevent building collapse, because most lives are lost in earthquakes as a result of building collapse. The code provisions for essential buildings intended to remain functional after a major earthquake have not yet been thoroughly tested.

If a healthcare facility or community desires to obtain more detailed information on the seismic hazard than is shown on the code maps, or if the location does not enforce a seismic code but there is concern about seismicity, the USGS Web page at www.USGS.gov, Earthquake Hazards Program, is an excellent resource. The USGS provides more detailed earthquake hazard maps for general regions such as the Western, Central, and Eastern United States. Local building or planning departments, fire departments, or other local emergency management agencies should be consulted for the availability of mapping for liquefaction, landslide, tsunami, and seiche. For even more localized information, the USGS provides seismicity information for any location in the United States on the basis of latitude and longitude or zip code. This information can be obtained by referring to the Seismic Hazard listings on the USGS Web page, and opening "Hazards by Latitude and Longitude," or "Hazards by Zip Code." These listings show information on the expected maximum shaking that is estimated for the location. The information and terminology are quite technical, and may need to be interpreted by qualified staff at the responsible local code office, a structural engineer, or other knowledgeable seismic professional.

2.2 SEISMIC BUILDING DESIGN

Seismic design is highly developed, complex, and strictly regulated by codes and standards. Seismic codes present criteria for the design and construction of new structures subject to earthquake ground motions in order to minimize the hazard to life and to improve the capability of essential facilities to function after an earthquake. To these ends, current building codes provide the minimum requirements necessary for reasonable and prudent life safety.

More basic information about seismic design of buildings can be found in FEMA 454, *Designing for Earthquakes* (FEMA, 2007)

Building design codes for cities, States, or other jurisdictions throughout the United States are typically based on the adoption, sometimes with more restrictive local modification, of a model building code. Up until the mid-1990s, there were three primary model building code organizations: Building Officials and Code Administrators International, Inc. (BOCA), International Conference of Building Officials (ICBO), and Southern Building Code Congress International, Inc. (SBCCI). In 1994, these three organizations united to found the International Code Council (ICC), a nonprofit organization dedicated to developing a single set of comprehensive and coordinated national model construction codes. The first code published by ICC was the 2000 International Building Code (IBC; ICC, 2000) and was based on the NERHP Provisions. The IBC now references ASCE 7, *Minimum Design Loads for Buildings and Other Structures* (ASCE, 2005) for its seismic provisions. Some jurisdictions in the country may still be using the Uniform Building Code (UBC) seismic provisions (its final update was in 1997), while most have adopted or are preparing to adopt the IBC. In this document, code references are to the IBC Code and to its seismic standard, ASCE 7.

Seismic code requirements cover:

- A methodology for establishing the design ground motion at any site based on seismicity and soil type

- Procedures for the seismic analysis of the building structure and key nonstructural components and systems
- Some detailed design requirements for materials, systems, and components
- Definitions of irregular building configurations and limitations on their use
- Building height limitations related to structural type and level of seismicity

Current codes and seismic design practices have evolved rapidly as the result of intensive research and development in the United States and elsewhere during the second half of the twentieth century. The advances in the development of the code during this period are illustrated by the fact that the 1961 Earthquake Provisions of the Uniform Building Code took seven pages, eight equations, and one map of the United States. The current provisions in the IBC cover about 80 pages, 96 equations, and 22 maps of the United States.

2.2.1 THE EQUIVALENT LATERAL FORCE (ELF) ANALYSIS METHODOLOGY

Of the 96 equations in the IBC, the *Equivalent Lateral Force* (ELF) equation is the key element in the most-used code methodology for determining seismic forces. This force is termed the *equivalent* force because it represents, in greatly simplified and reduced form, the complex to-and-fro, multidirectional earthquake forces with a single static force applied at the base of the building. Once this force is determined, all the structural components of the building (walls, beams, columns, etc.) can be analyzed through other code-prescribed procedures to determine what proportion of this force must be assigned to each of them. This general methodology is characteristic of all seismic codes throughout the world.

The ELF equation is derived from Newton's Second Law of Motion, which defines inertial force as the product of mass and acceleration. The ELF equation replaces Newton's acceleration with an acceleration coefficient that incorporates some of the other factors necessary to represent more accurately the acceleration of the mass of the building, which is generally higher than the ground acceleration. To determine this coefficient, the code provides another equation and additional coefficients that encompass most of the characteristics that affect the building's seismic performance. The ELF procedure is used for the great majority of build-

ings. Buildings of unusual form, or with other special features or site conditions, may be required to use more complex analytical methods.

Hospitals are classified in the building code as Occupancy Category IV—“essential for post-earthquake response and recovery”—and therefore have special design requirements intended to improve performance. Designers should use 50 percent greater earthquake forces for design of Category IV buildings than for normal buildings, which will provide an additional safety factor and reduce potential structural damage. In addition, design rules for Category IV buildings allow less movement between floors during earthquake shaking, reducing nonstructural damage to windows, walls, stairways, and elevators. Lastly, these buildings are required to incorporate more complete and stronger anchorage and bracing of nonstructural components and systems than normal buildings.

2.2.1.1 Acceleration

The most common and widespread cause of earthquake damage is ground shaking caused by the seismic waves that radiate out from the focus of the earthquake. The waves begin like ripples in a still pond when a pebble is thrown into it, but rapidly become more complex. There are four main wave types, of which “body” waves, within the earth, are most important for seismic design purposes. First to arrive at a given site is the *P* or *Primary* wave: this wave successively pushes and pulls the ground along the wave front as it moves forward. The effect is felt as a sharp punch—it feels as if a truck has hit the building. The *P* wave is followed by *S*, the *secondary* or *shear* wave, which is a lateral motion, back and forth, but perpendicular to the wave front.

The nature of the waves and their interactions are such that actual movement of the ground will be random: predominantly horizontal, often with considerable directional emphasis and sometimes with a considerable vertical component. Because of the random nature of the shaking, structures must be designed on the assumption that earthquake forces will come from all directions in very rapid succession, often fractions of a second apart.

The *inertial* forces inside the building, generated by ground shaking, depend on the building’s mass and acceleration.¹ The seismic code provides 22 maps that provide values for *spectral acceleration* (the acceleration to be experienced by structures of different periods). These values, with some

¹ Acceleration is the change of velocity (or speed) in a certain direction over time, and is a function of the earthquake characteristics: acceleration is measured in “g,” which is the acceleration of a falling body due to gravity.

additional operations, are inserted into the ELF equation and provide the acceleration value and eventually the base shear value for the structure.

Figure 2-4 shows an example of a portion of map from the IBC, showing contour lines of spectral acceleration. The numbers are the acceleration values to be used in the equation, based on the project location.

Figure 2-4:
Portion of an
earthquake ground
motion map used in
the seismic code

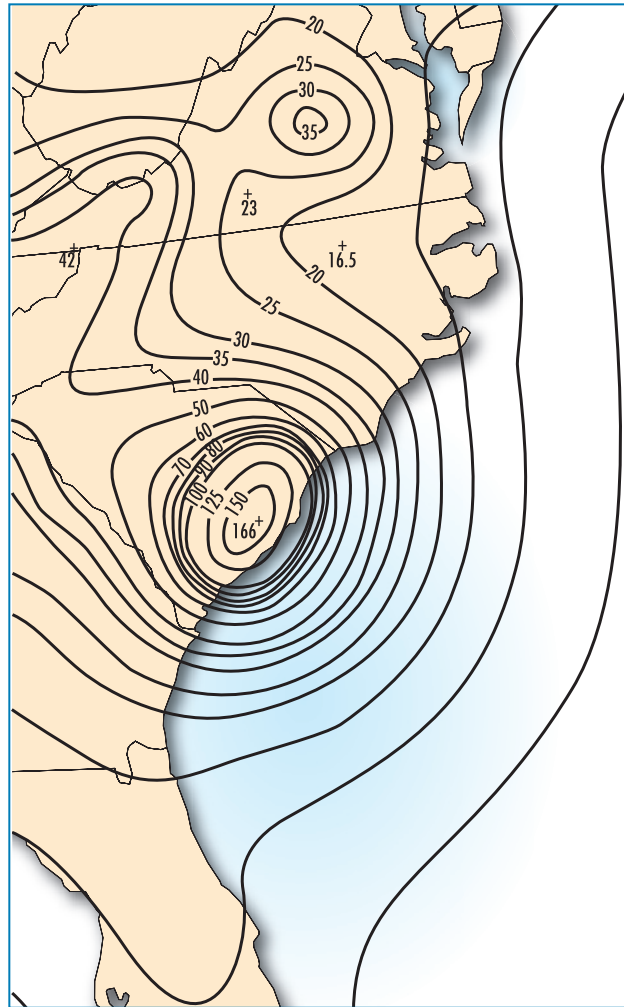

2.2.1.2 Amplification and Soil Type

As seismic vibrations propagate towards the earth's surface, they may be amplified depending on the intensity of the shaking, the nature of the rock and, above all, by the surface soil type and depth. Earthquake shaking tends to be more severe on soft ground than in stiff soil or rock, which produces greater building damage in areas of soft soils. This amplification is most pronounced for shaking at longer periods and may not be significant at short periods. Studies after the 1989 Loma Prieta Earthquake showed that shaking in the soft ground was 2.5 to 3.5 times that of shaking in rock.

The ELF equation deals with soil amplification by introducing a soil type coefficient in the process of determining the acceleration coefficient. The code defines six soil types, ranging from hard rock to very soft soil, and provides varying coefficients that relate soil type to building period, because the amplification is also modified by building period.

2.2.1.3 Building Period

All objects have a natural or fundamental period. This is the rate at which they will vibrate if they are given a horizontal push. When a building begins to vibrate as a result of ground motion, it will tend to sway back and forth at its natural period (Figure 2-5).

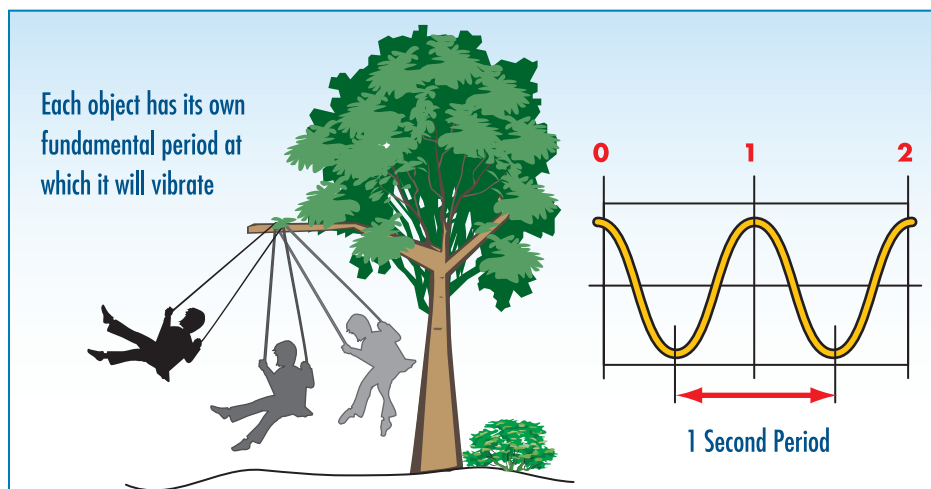
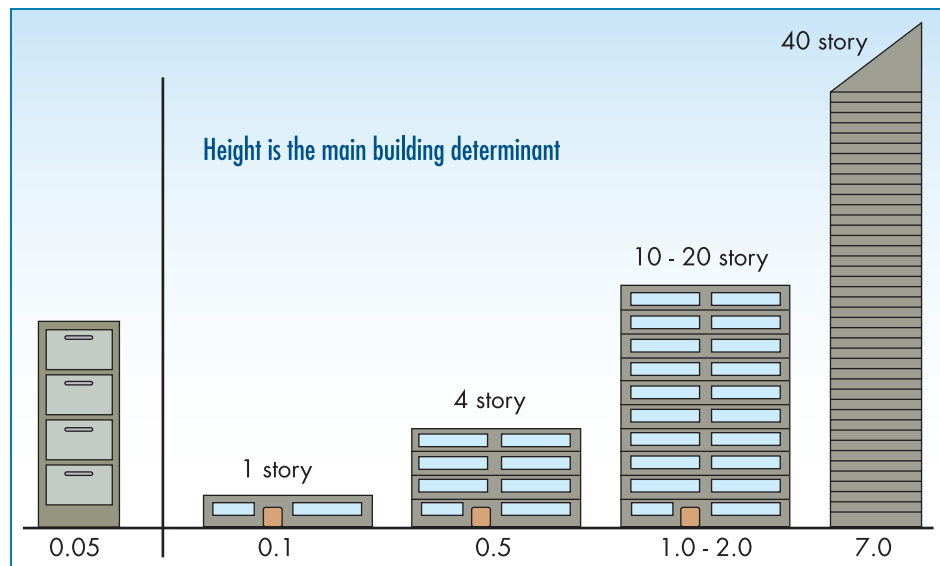

Figure 2-5:
Natural period

More complex structures will oscillate at several different periods, the longest one (greatest amount of time to complete one cycle) often being called the fundamental period. The fundamental periods of structures vary from about 0.05 second for a piece of equipment anchored to the ground to about 0.10 second for a one-story building. Taller buildings between 10 to 20 stories will oscillate in the fundamental mode at periods of between 1 and 2 seconds. The building height is normally the main determinant of building period (Figure 2-6), although more technically, the period is based on the mass and stiffness characteristics of the structure.

Acceleration within the building is influenced by its period, and diminishes as the period increases (the motion changes from abrupt shocks to a gentler swaying) as explained in Section 2.1.3.1.

Figure 2-6:
Period (in seconds)
and building height



2.2.2 CRITICAL BUILDING CHARACTERISTICS

2.2.2.1 Period and Resonance

As described in Section 2.1.3.1, the natural period of a building measures the time it takes to vibrate one full cycle. This basic characteristic of the structure will determine to a large degree how a building responds to earthquake ground shaking. Short, stiff buildings will have a short period and will shake with sharp, jerky movements (high accelerations), which will tend to cause contents such as equipment or furniture to slide around and possibly overturn. Taller, more flexible buildings will have longer periods and “shake” slower and smoother, but with larger “to and fro” movement than short buildings. The larger movements may create more relative displacement between floors and cause damage to walls, stairs, and elevators connected to multiple floors. In rare cases, buildings with periods over about 1.5 seconds on soft sites may match the vibration patterns of the site and resonate, causing large amplifications of the motions within the buildings.

2.2.2.2 Damping

A pendulum—or a child’s swing—is a very effective oscillator, and will continue to swing for many minutes after a push, although the extent of the swinging, or amplitude, will gradually diminish. Buildings and other objects do not oscillate as effectively because the vibration is damped, or reduced. The extent of damping in a building depends on the structural system, materials of construction; how the structural components are connected; and on the type and quantity of architectural elements such as

partitions, ceilings, and exterior walls. A high level of damping, in which the vibration of the building will rapidly diminish, is a desirable feature.

2.2.2.3 Nonlinear Behavior

It is generally not cost-effective to design buildings to be completely undamaged in strong earthquake motion. Building codes require designers to base their designs on forces that are not as great as the shaking can generate, on the assumption that the building's structure will deform and absorb part of the energy, thus limiting the forces that can be generated. These severe deformations represent “nonlinear behavior” and structural damage, ranging from minor (that can be left alone) to more serious (that will require repair). The building code has been “tuned” over the last 5 or 6 decades by adjusting code requirements according to the results of detailed observations of the behavior of buildings. Nonlinear deformations are expected in hospitals and other critical buildings, but to a lesser extent than normal buildings. The intent is to minimize structural damage to enable the buildings to remain occupied after the shaking.

Some materials and structural systems can accept nonlinear behavior better than others and are thus considered superior seismic systems.

2.2.2.4 Ductility

Ductility is the characteristic of certain materials—steel in particular—that fail only after considerable distortion or deformation has occurred. This is why it is more difficult to break a metal spoon by bending it than one made of plastic. The metal object will remain whole, though distorted, while the plastic spoon will break suddenly without warning (Figure 2-7). This property of materials is used to ensure that a building may adequately resist more than its design ground motion.

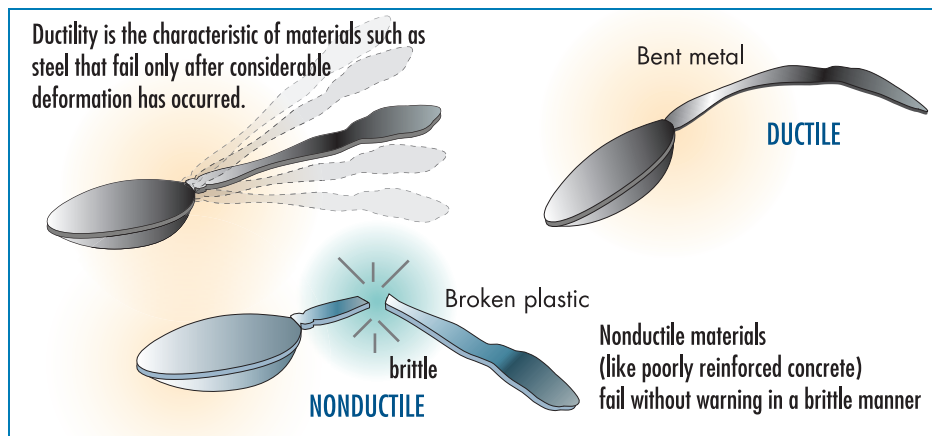

Figure 2-7:
Ductility

The deformation of metal, even in the spoon, absorbs energy and defers absolute failure of the structure. Brittle materials, such as unreinforced masonry or ceramic tile, fail suddenly with a minimum of distortion. Ductility is an important characteristic of the structural system. Thus, buildings with appropriate seismic designs are either designed so that the materials and connections will distort but not break, in case they are subjected to forces higher than those required by the code, or they are designed for very large forces. Some structural materials, like masonry and concrete, are brittle on their own, but when properly combined with steel reinforcing bars, can exhibit high ductility. This characteristic of the structural system is also considered in the ELF methodology.

2.2.2.5 Strength and Stiffness

Strength and stiffness are the two of most important seismic characteristics of any structure. Two structural beams may be equally strong (or safe) in supporting a load, but may vary in their stiffness—the extent to which they bend or deflect in doing so. Stiffness is a material property but is also dependent on shape. For vertical forces this is usually the only aspect of stiffness that is of concern. When floor joists are designed for a house, for instance, their deflection rather than strength is what often dictates their size. Typically, an unacceptable amount of deflection will occur well before the members are stressed to the point at which they break.

In seismic design, there is another very important aspect to stiffness. The problem of determining the overall lateral force on the building by multiplying its weight by its acceleration has already been discussed. But how is this force distributed among the various structural members so that the engineer can design each one appropriately? Relative stiffness enters into this issue because the applied forces are “attracted to” and concentrated at the stiffer elements of the structure—in engineering terms, the forces are distributed in proportion to the *stiffness* of the *resisting elements*. Mathematically, the stiffness of a structural member varies approximately as the cube of its length: thus one column that is half the length of another will be eight times stiffer (2^3) and will be subject to eight times the horizontal load of the long column. This concept has serious implications for structures with lateral members of varying lengths, and in designing such a structure the engineer tries to equalize the stiffness of the resisting elements so that no one member or small group of members takes a disproportionate amount of the overall load (Figure 2-8).

Short columns represent a problem that emphasizes the need for good structural seismic design. Columns in this category may not even be part of the lateral force resisting system. Nevertheless, if the structural and nonstructural components create such a condition, these columns are likely to be severely damaged during strong ground shaking.

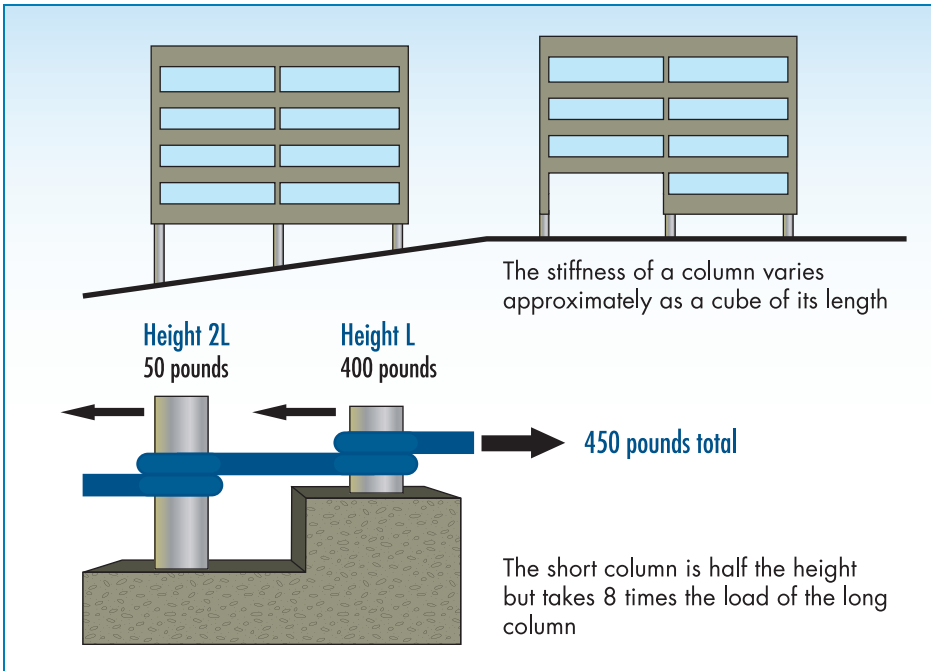

Figure 2-8:
The short column problem

2.2.2.6 Drift

Drift is the term used in seismic design to describe the horizontal deflection of structural members in response to seismic forces. In the seismic code, limits are set on the amount of drift permitted. This is done to ensure that the structure will not be designed to be so flexible, even if structurally sound, that its nonstructural components will be unacceptably damaged. Drift is limited on a story basis. The allowable story drift is limited to floor-to-floor height times 0.010 (1 percent of the floor height) for essential buildings and 0.015 (1.5 percent of the floor height) if the nonstructural components have been designed to accommodate drift. A story drift of 0.010 is equivalent to a deflection of 1-1/2 inches for a floor-to-floor height of 12 feet 6 inches (Figure 2-9).

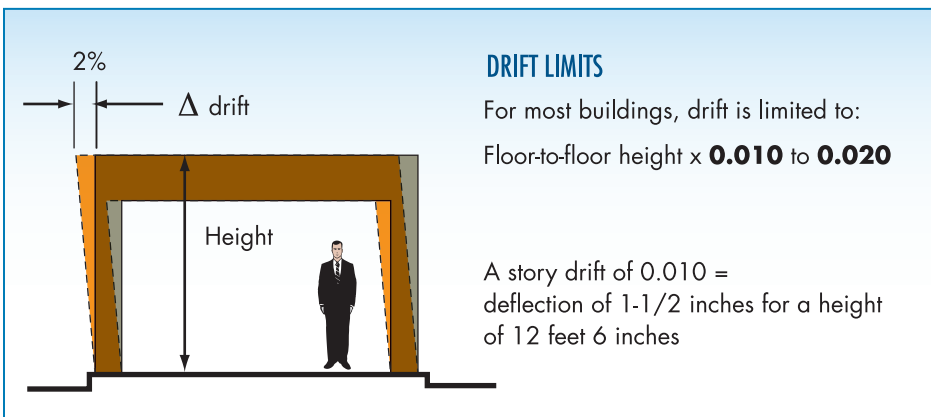

Figure 2-9:
Allowable story drift

2.2.2.7 Configuration: Size and Shape

Experience has shown that the architectural form of a building has a major influence on its performance during ground motion. This influence is the result of the three-dimensional interaction of all the structural systems and all architectural components when subjected to earthquake forces. For certain architectural forms, the *response of the building* can become very complex and the earthquake forces can become concentrated and distributed in undesirable ways. The term *building configuration* is used in seismic design to determine the architectural form of the building.

The kinds of unusual conditions that warrant concern are a result of early architectural decisions that determine the configuration of the building. In making these decisions, the architect plays a major role in determining the seismic performance of the building and can make it easy or difficult for an engineer to develop an efficient and cost-effective structural design. For seismic design purposes, configuration can be defined as *building size and shape; the size and location of the structural elements; and the nature, size, and location of nonstructural elements that may affect structural performance*. The latter include such elements as heavy and/or stiff nonstructural walls, staircases and elevator shafts, exterior wall panels, and heavy equipment items.

The seismic significance of the building configuration is that it determines both the way forces are distributed throughout the structure and the relative magnitude of those forces. Seismic codes distinguish between regular and irregular configurations, and it is the latter that may have a detrimental influence on the effectiveness of the seismic engineering and on building seismic performance. Configuration irregularity results in two main undesirable conditions—stress concentrations and torsional forces.

2.2.2.8 Stress Concentrations

Irregularities tend to create abrupt changes in strength or stiffness that may concentrate forces in an undesirable way. Stress concentration means that an undue proportion of the overall forces is concentrated at one or a few points of the structure, such as a particular set of beams, columns, or walls. Those few members may fail, and by chain reaction bring down the whole building. Stress concentration can also be created by vertical irregularity. The most serious condition of vertical irregularity occurs when a building has a soft or weak story, usually the ground floor, which is significantly weaker or more flexible than those above. This design creates a major stress concentration at the points of discontinuity, and in extreme cases may lead to collapse unless adequate design is provided for such points. Figure 2-10 shows some types of soft story design, and Figure 2-11 shows the collapse mechanism that is created.

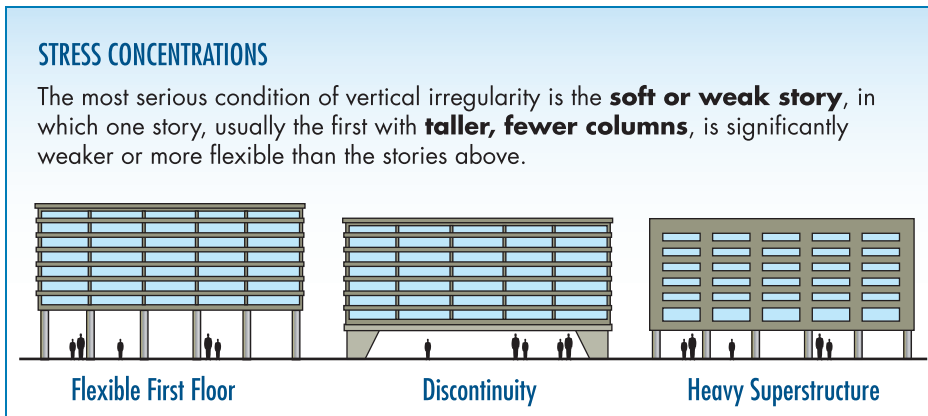

Figure 2-10:
Types of soft and weak story structures

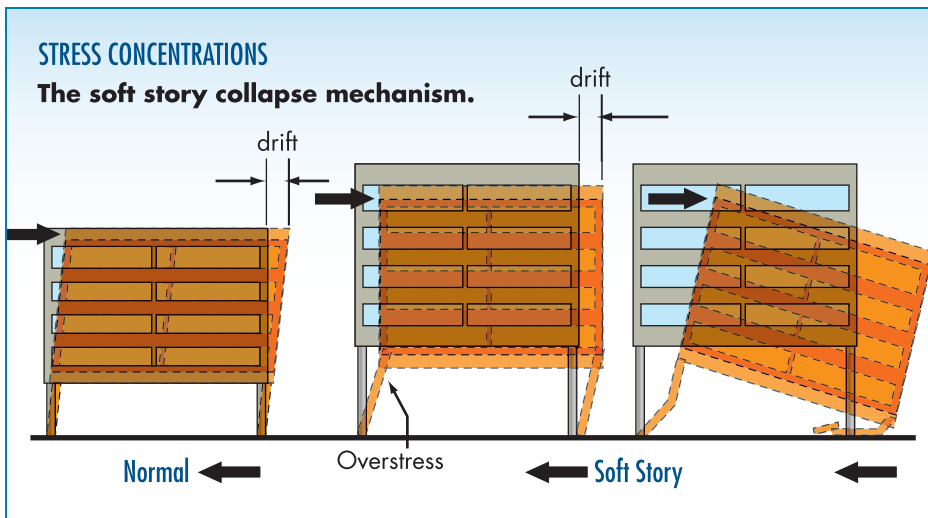

Figure 2-11:
Soft story collapse mechanism

The severe damage to Olive View Hospital in 1971, described in Section 2.3.1.1, was largely the result of a soft first story design. Such soft or weak stories are not permitted in current seismic designs.

2.2.2.9 Torsional Forces

Irregularities in building configuration may produce torsional forces, which complicates the analysis of building resistance. Torsion is created by a lack of balance between the location of the resisting elements and the arrangement of the building mass. Engineers refer to this as eccentricity between the center of mass and the center of resistance, which tends to make the building rotate around the latter and create torsion within the resisting elements.

The IBC lists a dozen conditions of irregularity (six horizontal and six vertical) for which special design requirements apply. These special requirements either restrict the level of irregularity, amplify forces to account for it, or require more sophisticated analysis. A severe soft first story is specifically prohibited, although it is often encountered in existing buildings.

As explained in Section 2.2.1.1, the weight of the floors, walls, and roof contributes to the main lateral forces exerted on the structure through the center of mass, usually the geometric center of the floor plan. If the resistance provided by the building components is exerted through this same point (the center of resistance), then there is no torsion and balance is maintained. As shown in Figure 2-12, conditions of eccentricity—when the centers of mass and resistance are offset—produce torsional forces.

Figure 2-12:
Torsion

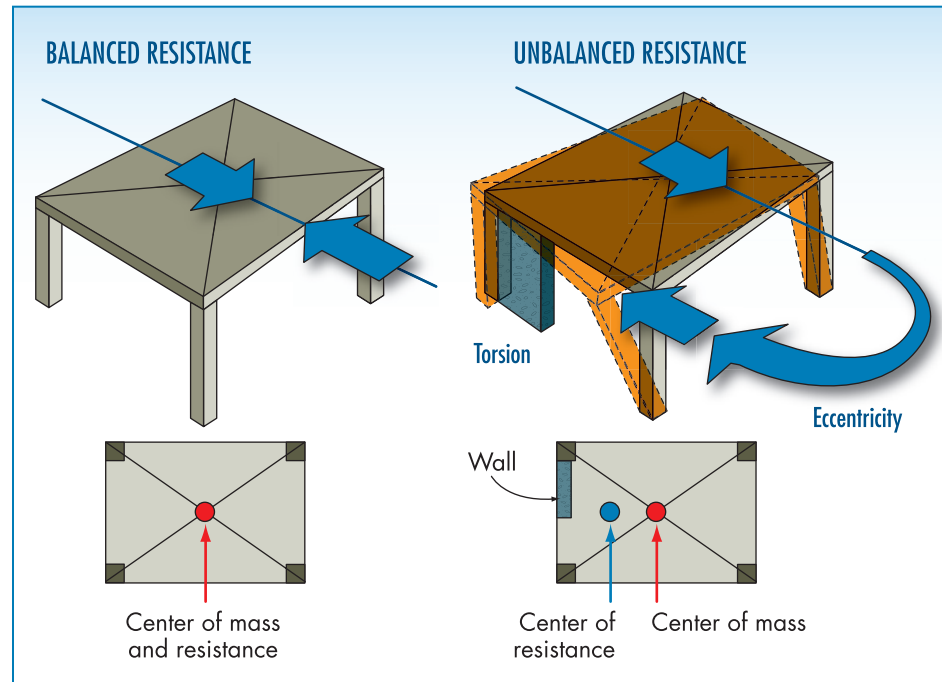

One building configuration that is most likely to produce torsion features re-entrant corners (buildings shaped in plan like an “L” or a “T,” for example). The wings of such buildings tend to twist and result in torsion and stress concentration at the “notch” where the wings meet, also called a re-entrant corner (Figure 2-13).

Figure 2-13:
The re-entrant corner building

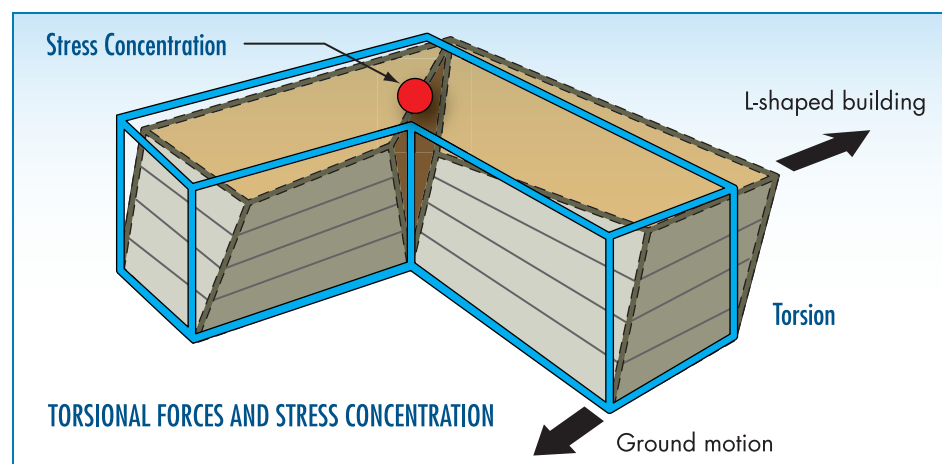

Buildings that have large variations in their perimeter resistance on different facades of the building also tend to produce torsion. Such variations often occur when some facades have large areas of glazing while the others have solid walls.

Irregular configurations generally arise because of functional planning and programming requirements, or sometimes because of the architect's or owner's desire to create an original or striking architectural form.

Hospitals often have irregular and complicated configurations as a result of their functional complexity. Broadly speaking, smaller hospitals are usually planned in one or two stories with horizontal-planned layouts; large hospitals often have a vertical tower for patient rooms elevated above horizontally planned floors for the diagnostic, treatment, and administrative services. Emergency services are generally placed at the ground floor level, with direct access for emergency vehicles. However, new developments in hospital design (see Section 1.2.4) represent a radical departure from this traditional hospital morphology. The new designs are based on decentralization of functions, and the introduction of natural environment into hospital buildings. New hospital buildings have even more complex configurations consisting of fragmented blocks interspersed with courtyards and gardens, where different blocks frequently have not only different shapes, but different structural systems as well.

The structural design for a hospital, however, should still focus on reducing configuration irregularities to the greatest extent possible and ensuring direct load paths. Framing systems need careful design to provide the great variety of spatial types necessary without introducing localized irregularities (Figure 2-14).

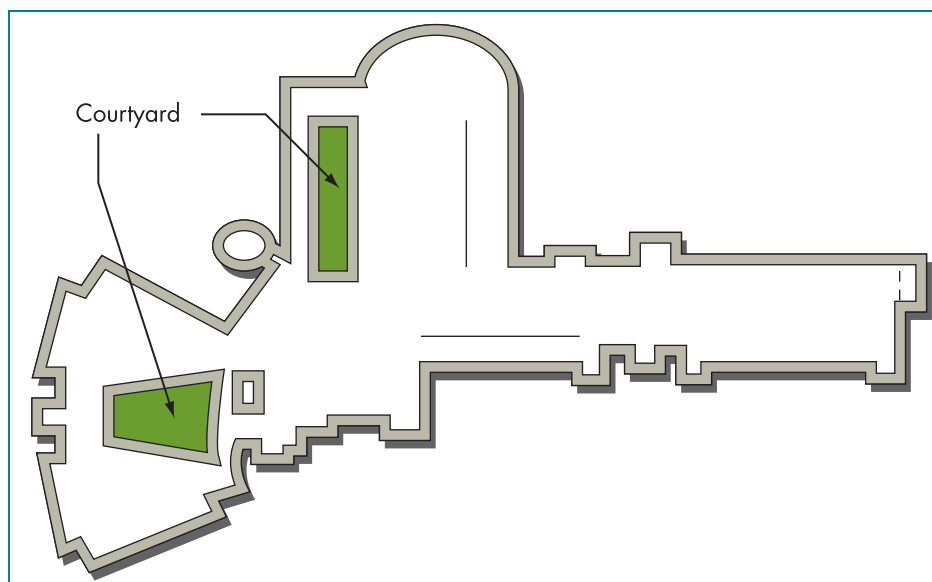

Figure 2-14: Complex footprint of a large community hospital. Shaded areas represent open courtyards.

2.2.3 SPECIFICATIONS FOR PERFORMANCE-BASED SEISMIC DESIGN

Beginning with the 1989 Loma Prieta earthquake in the San Francisco Bay Area, the importance of the consequences of damage, other than endangering life safety, has been increasingly recognized, not only in hospitals and other critical facilities, but in all buildings. A major effort to develop guidelines for seismic rehabilitation of buildings was funded by FEMA in 1992, and published as FEMA 273 (1997). Subsequently, this guideline was improved and republished as FEMA 356 (2000), and in 2007 was made a standard by the American Society of Civil Engineers (ASCE 41).

2.2.3.1 Performance Levels

As a result of the high cost of retrofit and the growing interest in understanding the various performance levels of buildings in earthquakes, FEMA 273 described a variety of seismic performances for both structural and nonstructural systems that could be targeted in design. These performances were summarized in a matrix (see Table 2-1) that allowed specification of a given performance level by combining the desired structural performance with a desired nonstructural performance. Four overall performances levels from that table were highlighted as discussed below. These performance levels were developed to be applicable to any building with any occupancy, as appropriate.

Table 2-1: Combinations of Structural and Nonstructural Seismic Performance

Nonstructural Performance Levels	Structural Performance Levels and Ranges					
	S-1 Immediate Occupancy	S-2 Damage Control Range	S-3 Life Safety	S-4 Limited Safety Range	S-5 Collapse Prevention	S-6 Not Considered
N-A Operational	Operational 1-A	2-A	Not recommended	Not recommended	Not recommended	Not recommended
N-B Immediate Occupancy	Immediate Occupancy 1-B	2-B	3-B	Not recommended	Not recommended	Not recommended
N-C Life Safety	1-C	2-C	Life Safety 3-C	4-C	5-C	6-C
N-D Hazards Reduced	Not recommended	2-D	3-D	4-D	5-D	6-D
N-E Not Considered	Not recommended	Not recommended	Not recommended	4-E	Collapse Prevention 5-E	No rehabilitation

Operational Building Performance Level (1-A)

Buildings meeting this target building performance level are expected to sustain minimal or no damage to their structural and nonstructural components. The building would be able to continue its normal operations, possibly with only slight adjustments, mainly with respect to power, water, and other utilities that may need to be provided from emergency sources.

Under low levels of earthquake ground motion, most hospitals should be able to meet or exceed this target building performance level. However, it would not be cost-effective to design buildings for this target building performance level under very rare, intense ground shaking, except for buildings that offer unique services or that contain exceptionally hazardous material.

Full functionality is normally considered difficult to achieve in the immediate aftermath of strong earthquake shaking. Offsite issues, such as staff availability and potential loss of utilities that are not under the control of the facility, may impair operations. In addition, relatively minor onsite damage to key components can significantly affect overall functionality. A single anchorage failure of the emergency generator, or a leak in one of the many pressurized water systems, can significantly disrupt hospital operations.

Immediate Occupancy Building Performance Level (1-B)

Buildings meeting this target building performance level are expected to sustain minimal damage to their structural elements and only minor damage to their nonstructural components. While it would be safe to reoccupy a building meeting this target building performance level immediately following a major earthquake, nonstructural systems may not function, either because of the lack of electrical power or damage to fragile equipment. Therefore, although immediate occupancy is possible, it may be necessary to perform some cleanup and repair and await the restoration of utility services before the building can function in a normal mode. The risk of casualties at this target building performance level is very low.

Many building owners may wish to achieve this level of performance when the building is subjected to moderate earthquake ground motion. In addition, some owners may desire such performance for very important buildings under severe earthquake ground shaking. This level provides most of the protection obtained under the Operational Building Performance Level, without the cost of providing full standby utilities and performing rigorous seismic qualification of equipment performance.

Immediate Occupancy is more realistic than the Operational performance level for most buildings, and at a minimum, should be the goal of all new hospital buildings. However, since even the smallest disruption of non-structural systems may be too detrimental for continued operation of a hospital, the owners and designers should consider a higher level of protection for critical hospital functions. For instance, it is recommended that provisions be made for independent operation of critical utilities for a minimum of 4 days. Critical utilities usually include electric power; water; the sanitary sewer; and, depending on the local weather conditions, fuel for heating and cooling.

Life Safety Building Performance Level (3-C)

Buildings meeting this performance level may experience extensive damage to structural and nonstructural components. Repairs may be required before re-occupancy of the building is allowed, although in some cases the repair may not be deemed cost-effective. The risk of casualties in buildings meeting this target building performance level is low.

This target building performance level entails somewhat more extensive damage than anticipated for new buildings that have been properly designed and constructed for seismic resistance.

The Life Safety level should prevent significant casualties among able-bodied hospital occupants, but may not protect bed-ridden patients. In these circumstances, life safety level of protection is not appropriate for new hospitals.

Collapse Prevention Building Performance Level (5-E)

Although buildings meeting this target building performance level may pose a significant hazard to life safety resulting from failure of nonstructural components, significant loss of life may be avoided by preventing collapse of the entire building. Many buildings meeting this performance level may, however, be complete economic losses.

This level has been sometimes selected as the basis for mandatory seismic rehabilitation ordinances enacted by municipalities, as it results in mitigation of the most severe life-safety hazards at the lowest cost. Collapse Prevention is intended to prevent only the most egregious structural failures, and includes no consideration for continued occupancy and functionality of a hospital, the economics of damage repair, or damage to nonstructural components.

2.2.3.2 New Developments in Performance-Based Design

Although developed for use in the process of seismic rehabilitation of older buildings, the aforementioned damage descriptions have filled a void and have become an interim standard for describing seismic performance of both new and existing buildings.

The goal of performance-based earthquake engineering has thus become the development of methods to predict the expected losses adequately, measured by the risk of casualties, the cost of damage repair, and the length of building downtime. These losses are to be calculated on a cumulative and probabilistic basis, allowing communication with stakeholders based on losses in a given scenario earthquake, the losses due to a probabilistically determined event, or the average annual losses over a given time period.

Since the publication of FEMA 273, performance-based earthquake engineering has continued to develop, particularly through research performed at the Pacific Earthquake Engineering Research Center, one of three major earthquake research centers funded by the National Science Foundation, and through the FEMA funded project, *Next Generation Performance-Based Seismic Design Guidelines*, FEMA 445 (2006). When this work is completed, the global performance states used by FEMA 356 will be redefined better to reflect current knowledge and to communicate the potential losses to stakeholders more effectively.

The example of California shows how earthquake damage affects legislation. The 1971 San Fernando earthquake was particularly damaging to hospital buildings, most notably the Olive View Medical Center, a brand new facility that was damaged so badly that it was eventually demolished. Based on similar experiences with schools, the legislature passed the Hospital Seismic Safety Act (HSSA) in 1972. The intent of the law was both to protect acute care patients and to provide post-earthquake medical care. The law was patterned after the Field Act covering schools in California, specifying the same State review agency, and stipulating design by specially experienced and approved "Structural Engineers." It covered new buildings only and provided for a "Building Safety Board" of industry design professionals and facility experts, appointed by the Director of Health Services, to advise the State on implementation of requirements.

The law and regulations included four main considerations:

- Geologic hazard studies for sites
- Structural design forces in excess of those used for "normal" buildings (initially a "K-factor" of 3.0; later, an importance factor, I , of 1.5)

(continued)

- Specific design requirements for nonstructural elements
- Strict review of design and inspection of construction

Surprisingly, only 23 years after the San Fernando earthquake, another damaging event occurred in almost the same spot. In January of 1994, the Northridge earthquake produced very large ground motions in the San Fernando Valley just north of Los Angeles. Just as the San Fernando event, the Northridge earthquake had a profound effect on hospital design in California. Although there were no failures in hospitals comparable to the Olive View disaster, several hospitals required evacuation as a result of failures of both structural and nonstructural systems. These high-profile evacuations once again put the hospital building inventory in the spotlight. Analysis and comparison of the performance of buildings in Northridge built before and after the HSSA clearly indicated its effectiveness. This analysis also indicated that further improvements were needed in the performance of nonstructural systems.

Senate Bill 1953, which introduced a plan to bring all pre-Act hospital buildings into compliance with the HSSA by the year 2030, was signed into law by the governor of California in September, 1994. Standards and regulations needed to implement the law included:

- Definition of structural vulnerabilities and evaluation standards
- Definition of nonstructural vulnerabilities and evaluation standards
- Standards for retrofit
- Building evaluations and facility compliance plans shall be submitted to the Office of Statewide Health Planning and Development (OSHPD) by January 1, 2001; Facility owners, 60 days after approval by OSHPD, shall submit building performance categories to local emergency service agencies and use the performance information to improve emergency training, response, and recovery plans
- Hospital buildings with a high risk of collapse cannot be used for acute care purposes after January 1, 2008. These buildings must be retrofit (to a "life safe" performance), demolished, or abandoned for acute care use by that date
- High-risk nonstructural systems (pre- and post-Act) shall be mitigated in accordance with priorities and timelines to be set in regulation by OSHPD, in consultation with the Hospital Building Safety Board
- All facilities shall be in substantial compliance with the intent of the HSSA by January 1, 2030

2.3 EARTHQUAKE DAMAGE TO HOSPITALS

Although earthquakes damage most manmade structures in similar ways, to understand the true consequences of damage to buildings with special occupancies and functions requires a much more detailed and accurate damage description than may be needed for other buildings. The effects of earthquake damage on hospital operations and the safety of occupants have been described below based on the experiences of hospitals in the United States and around the world.

Historically, buildings have been engineered to provide adequate life safety to occupants and passers-by from earthquake hazards. For most buildings, life safety is primarily threatened by building collapse or the debris falling into the street and neighboring buildings. A higher level of performance is required to address the life safety issues of hospitals, since patients often have limited mobility and are dependant on caregivers or specialized medical equipment.

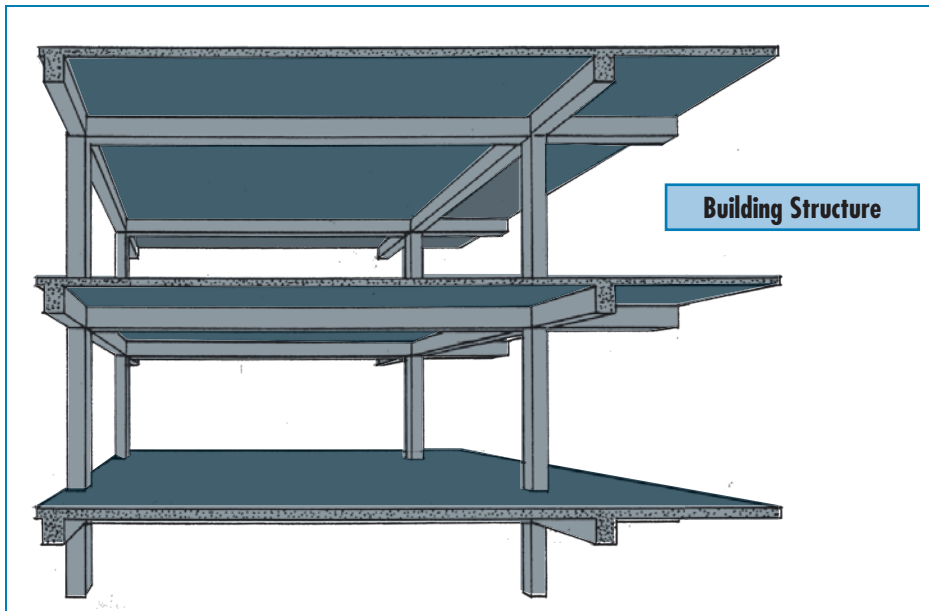

Figure 2-15a:
Structural and
nonstructural elements
of a building

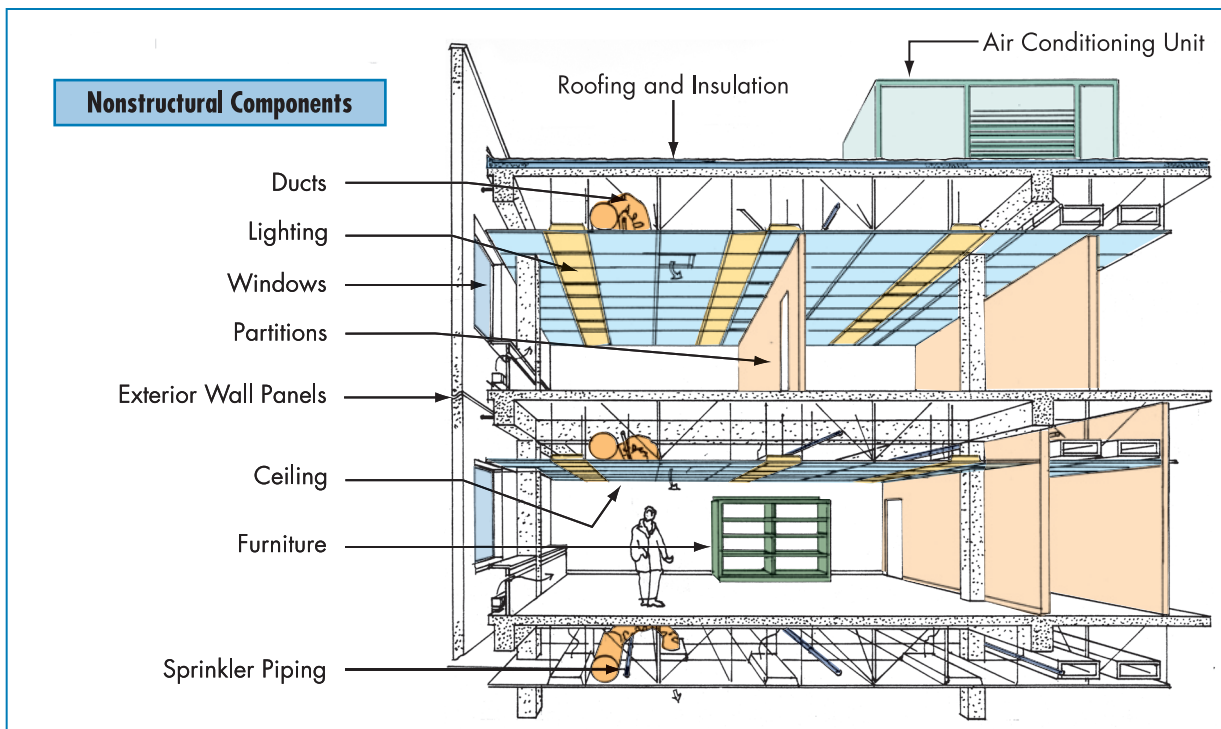

Figure 2-15b: Structural and nonstructural elements of a building

Figure 2-15 shows typical building components and systems present in hospital facilities. The structural elements consist of the foundations, columns, beams and slabs, walls, and braces that hold the building up against vertical gravity forces and horizontal wind and earthquake forces. The nonstructural elements include building service systems, such as electricity and lighting, heating and cooling, plumbing, and interior architectural systems, such as ceilings, floors, partitions, and other interior components. The building envelope includes the systems that separate the interior spaces from the exterior, both structural and nonstructural. It includes exterior walls and cladding, roof systems, doors and windows, and floors or slabs that separate the building interior from the ground. Contents and equipment are completely dependent on the type of occupancy and the function of the space, and range from items such as furniture encountered in a lobby or a waiting room, to highly technical equipment commonly present in treatment rooms. In addition, laboratories, pharmacies, bulk storage areas, and large central energy plants have highly specialized and frequently very sensitive equipment.

In general, both the building service systems and the contents of hospitals rank among the most complex and expensive of any building type. Furthermore, both the structural system and most of the nonstructural systems are required to perform without interruption after an earthquake to enable adequate functionality.

2.3.1 TYPES OF STRUCTURAL DAMAGE

When the ground shakes in an earthquake, the shaking is transferred to the building, potentially causing structural damage. The damage can consist of cracks in structural walls, bent or broken braces, or damage to columns and beams. Damage can range from minor (a few cracks), to major (parts of the structure rendered ineffective and potentially unsafe), to complete collapse. See Figures 2-16, 2-17, 2-18, and 2-19 for examples of structural damage.



Figure 2-16:
This concrete building suffered severe damage to the columns at the second floor level. It was deemed unsafe by the local jurisdiction and later demolished.



Figure 2-17:
A steel frame building with a post-earthquake "lean" to the right, seen particularly at the first floor. Severe damage was found in its beam-column joints and it was later demolished.

Figure 2-18:
Severe damage to a poorly reinforced masonry wall on a steam plant



Figure 2-19:
Damage to an exterior concrete wall. This hospital building was evacuated.



2.3.1.1 The Case of the Olive View Medical Center

The Olive View Hospital in the northern San Fernando Valley, owned by Los Angeles County in Southern California, was severely damaged on February 9, 1971, when the San Fernando earthquake damaged the almost-new facility so severely that it was later demolished. Over 500 patients were evacuated immediately after this event.

The 850-bed Olive View Hospital campus comprised over 30 buildings of various ages, but most notably featured a complex of buildings completed

in 1970, only months before the 1971 San Fernando earthquake. These “new” buildings included the five-story Medical Care Facility, the two-story Psychiatric Unit, the Heat and Refrigeration Plant, and several other smaller ancillary buildings such as a warehouse, assembly building, walkway canopy, and ambulance canopy. The 1970 buildings were all made of reinforced concrete and designed under the 1965 Los Angeles Building Code, which included seismic provisions. However, neither of these buildings had any special seismic protection features. In fact, the poor performance of this facility was one of the prime reasons for passage of California’s Hospital Seismic Safety Act (HSSA). The shaking experienced in the 1971 San Fernando earthquake was extreme; however, structural performance of these buildings was worse than the engineering community had expected. Subsequent investigations indicated that the buildings technically met the requirements of the code, but included features that made them particularly vulnerable to earthquake damage. Seismic codes were subsequently refined to prevent this type of vulnerability in future buildings.

The damage to Olive View Hospital buildings was nearly catastrophic. The first story of the medical treatment and care unit was over 15 inches out of plumb and near collapse (Figure 2-20). Three of the four exterior stair towers pulled away from the main building or collapsed completely, rendering them useless for egress (Figure 2-21). The Ambulance Canopy collapsed onto the parked ambulances and destroyed them. The first story of the Psychiatric Unit collapsed, but all the occupants were on the second floor at the time.

Almost immediately after the event, the patients in the Psychiatric Unit began assembling in a parking lot adjacent to their facility. The need to evacuate was obvious, and the second floor wards were only feet from the ground after the first floor collapse (see Figure 2-22). Controlling and tracking these patients was nearly impossible, particularly in the first few hours. Within 5 hours, evacuation was underway in the main building using interior stairwells. The building had no power and therefore no elevators or lights. The nurses evacuated their own units, ambulatory patients first, and, when sufficient assistance was available, non-ambulatory patients. By that time, a network of ambulances and helicopters had been set up for transfer to other facilities (Arnold, 1983; Lew, 1971; NOAA, 1973).

Subsequent analysis of the effects of this earthquake on the hospital noted, as particularly troublesome, the lack of functioning communications, either internal or external, the lack of an effective evacuation plan or identified assembly area, and the lack of any control or tracking of medical records.

Figure 2-20:
Aerial view of 1971
Olive View Hospital
SOURCE: NOAA, 1973

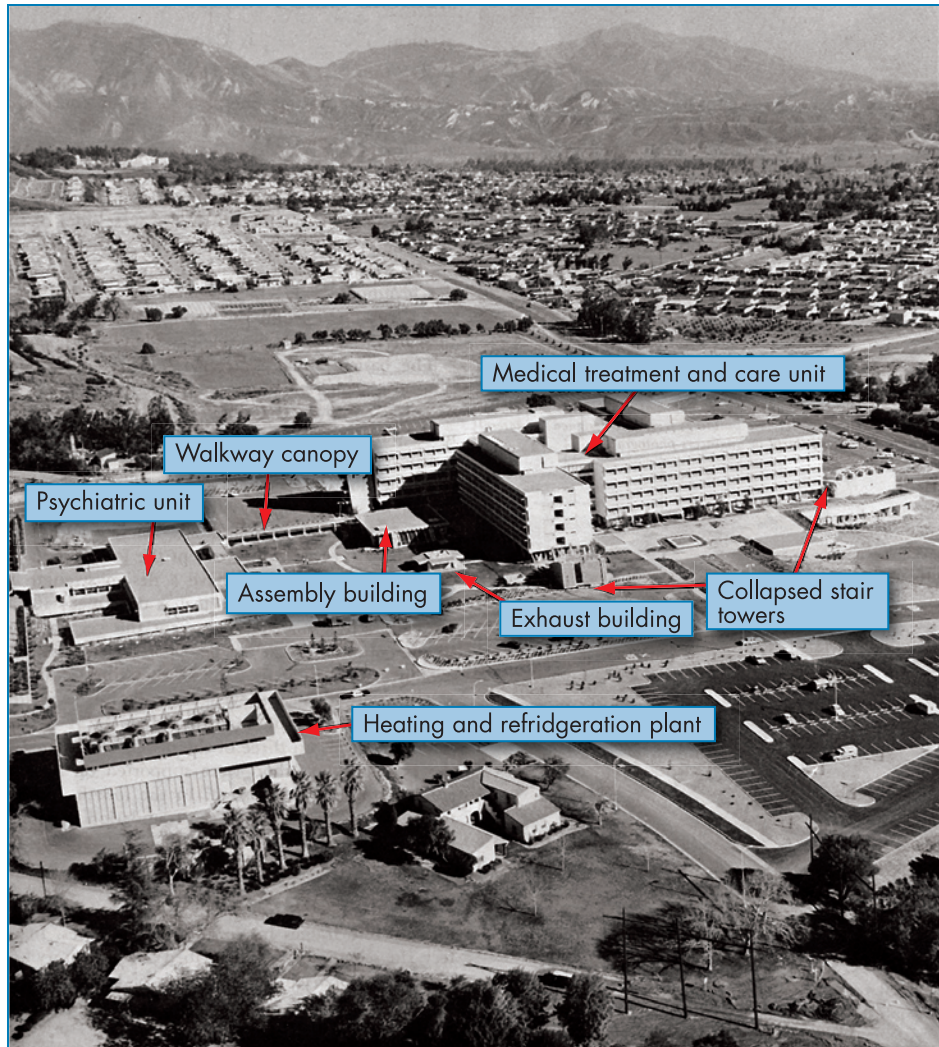

Figure 2-21:
Collapsed stair tower
in main building of
Olive View Hospital





Figure 2-22:
Completely collapsed
first level (not visible)
of Psychiatric Unit

2.3.2 NONSTRUCTURAL DAMAGE

When the ground shakes the structure, the structure shakes everything that is in it or on it, including the building envelope and components of the interior nonstructural systems. This shaking can damage most components directly. Indirect damage, resulting from structural deformation between floors, can cause damage to all the systems connected to these structural components.

Damage to architectural systems consists of broken windows and cracked exterior walls and interior partitions. In extreme cases, exterior walls and partitions topple completely. Ceilings are also vulnerable to damage and can break into small pieces or fall to the floor (see Figure 2-23).



Figure 2-23:
A damaged exit
corridor—dark and
barely passable

Damage to the building service systems can consist of sliding or overturning of equipment like boilers, generators, and fans, or swaying and possible fracture of mechanical ducts, pipes, and electrical conduit (see Figures 2-24, 2-25, and 2-26).

Figure 2-24:
Vibration isolation bearing assemblies on mechanical equipment collapsed due to seismic shaking—such movement breaks pipe or electrical connections to the equipment.

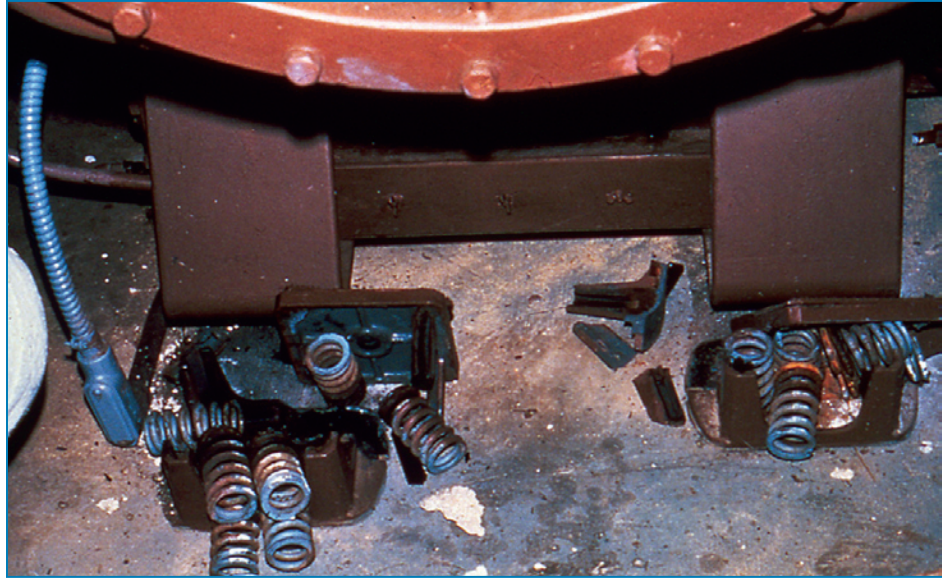
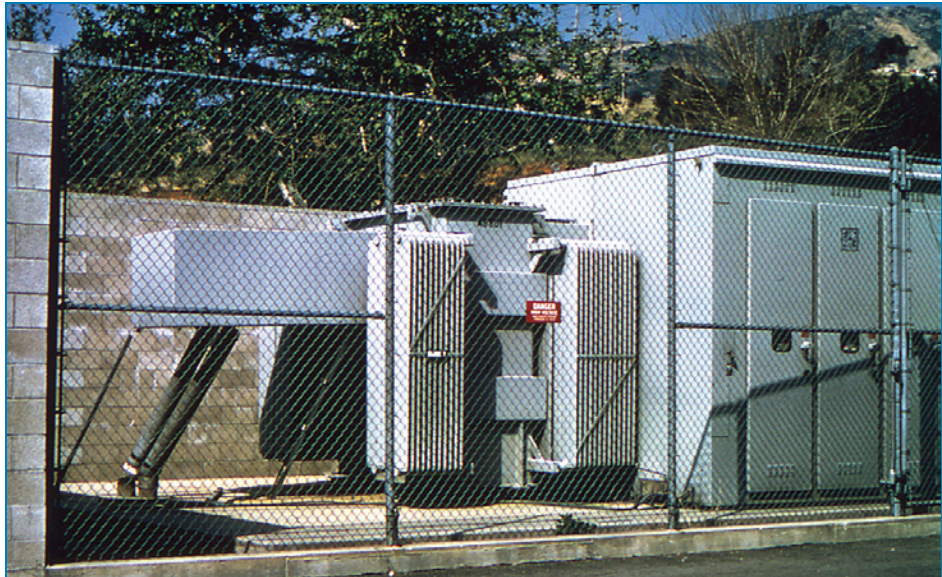

Figure 2-25:
A heavy transformer that moved several feet, breaking all connections



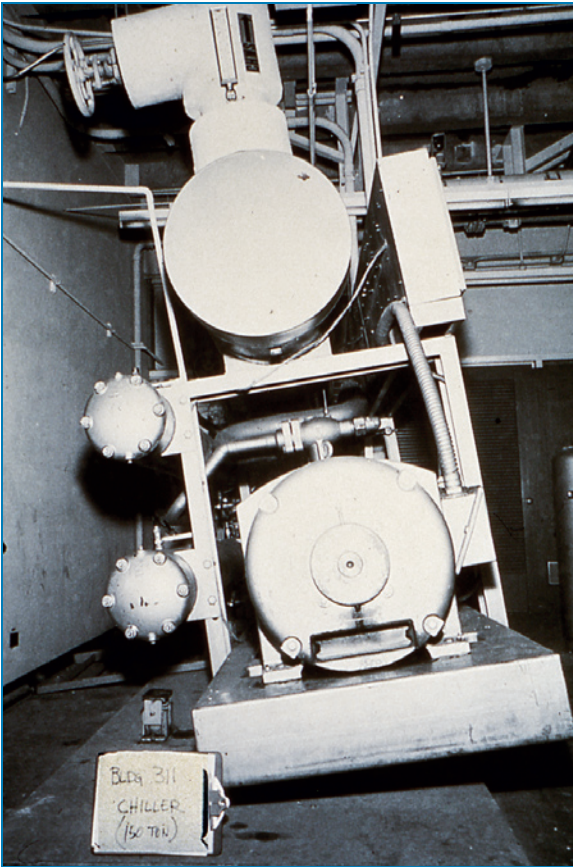

Figure 2-26:
A large chiller almost tipped over.

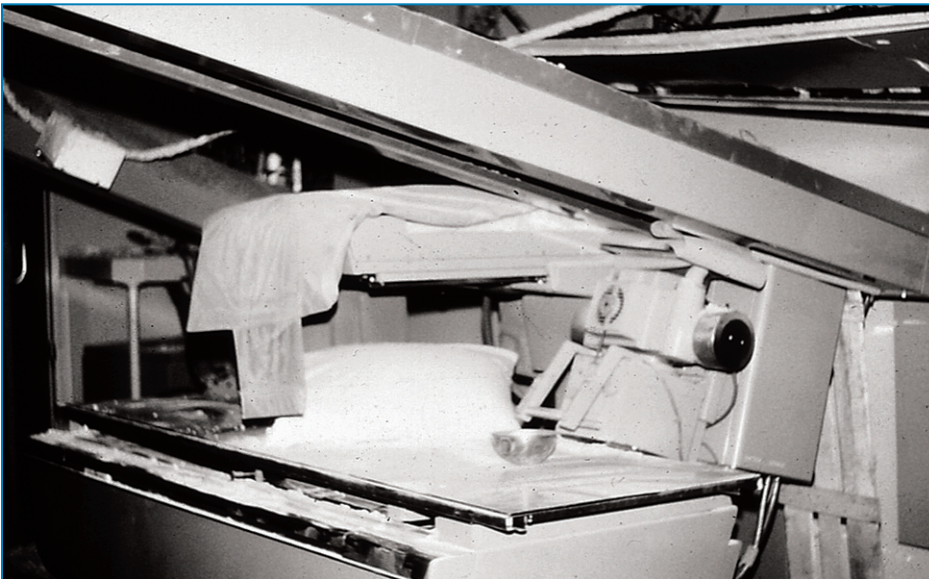

Figure 2-27:
Damaged radiology equipment that not only will not function, but has become a life-safety risk

Because of the wide variation of contents and equipment in a typical hospital, the type of damage experienced by these systems varies widely. For example, medical equipment, such as operating tables and lights, radiation and x-ray units, sterilizers, and patient monitors, is often heavy and

not well anchored to the structure (see Figure 2-27). Offices and storage rooms, such as the areas used to store critical supplies, medicine, medical records, chemicals, and fuel, can also be severely damaged by shaking (see Figures 2-28, 2-29, and 2-30).

Figure 2-28:
Chaos in a storage area similar to central storage or medical records



Figure 2-29:
Jumbled contents of a typical office





Figure 2-30:
Overturned tank
similar to medical gas
storage

2.3.2.1 The Case of New Olive View Medical Center

Nearly 15 years after the 1971 earthquake event that destroyed the Olive View Medical Center (see Section 2.3.1.1), a new hospital was opened on the same site in 1986 (see Figure 2-31). Built even stronger than required under the HSSA of 1972, the building has no basement and features a seismic system of concrete shear walls and steel plate shear panels. The building was also equipped with instruments to record its response in future earthquakes.



Figure 2-31:
Aerial view of “new”
Olive View Hospital
(1986)

Early in the morning of February 17, 1994, a Magnitude 6.7 earthquake occurred on a little known fault not generally considered dangerous, located near Northridge, about 10 miles from the hospital. The recorders captured exceptionally high accelerations of 0.82 g at the first floor and 1.7 g at the roof. The structure suffered little or no structural damage, but its stiffness and strength contributed to the transfer of unprecedented accelerations through the building, in some cases overwhelming the seismic anchorage and bracing provided for the building's nonstructural systems. Some of these components and systems were not considered sufficiently vulnerable to require special bracing.

Damage included the following (see Figures 2-25, 2-26, and 2-27):

- Shifting, and in some cases, failure, of anchorages of equipment at the roof level, where accelerations were the highest. This movement broke one or more chiller water lines, causing flooding in the top floors (see Figure 2-32).

Figure 2-32:
Anchor bolts
stretched by large
seismic accelerations
at roof level



- Excessive movement and failure of wall-mounted television brackets, causing some television units to fall.
- Extensive damage to suspended panelized ceilings, some exacerbated by leaks from water pipes from above.
- Excessive movement and interaction between gypsum board and other fire-rated ceilings and sprinkler lines, causing additional leaks.
- Movement at the copper tube reheat coils in the ceiling spaces, almost universally at the third through the sixth floor, causing leaks (see Figures 2-33 and 2-34).



Figure 2-33:
Damage to ceiling and fixtures from sprinkler breaks



Figure 2-34:
Detail of water damage to ceiling

- Damage to some equipment anchorage in the Central Plant and at the bulk oxygen tank.
- Damage to elevators, seven of which were temporarily out of service. Four had sustained severe damage as a result of derailed and bent counterweight frames.

Right after the earthquake event, administrators planned a partial evacuation of 79 patients, but by the afternoon, they decided to transfer all 377 patients to other facilities, despite the dangers associated with such a move. The evacuation was prompted primarily by water damage and lasted 41 hours (EERI, 1995; LACDHS, 1994; URS, 1996).

Despite vastly improved structural performance and compliance with the requirements for anchorage and bracing of nonstructural components and systems compared to the conditions in 1971, the hospital's operations were severely compromised. It was not ready to accept local casualties, but actually increased the load of neighboring facilities by requiring evacuation. The unexpectedly poor performance was caused by extraordinary ground motions, probably made more damaging to nonstructural systems and contents by the very stiff and strong structure of the hospital.

2.3.2.2 The Case of Kona Community Hospital, Hawaii

The Kona Community Hospital (KCH) is located in Kealahou, Kona, on the central west coast of the Big Island of Hawaii. It was originally a county hospital but became part of the State-owned Hawaii Health Systems Corporation in 1996. KCH is a full service medical center and is the primary health care facility serving West Hawaii. The facility has 33 acute medical-surgical beds, a 9-bed intensive care unit, 7 obstetric beds, an 11-bed behavioral health unit, and a 34-bed skilled nursing/long term care wing.

The KCH campus includes several buildings, but the primary medical facility occupies a three-story L-shaped building that consists of the original 60,500-square-foot block built in 1972, and an 18,300-square foot addition built in 1989. Both structures are concrete, rectangular in plan, and each forms one leg of the L shape. The site slopes east to west creating two stories above grade and one basement floor on the east, and three stories above grade on the west face. The lateral force (wind and earthquake) resisting system of the original building consists of concrete pier shear walls that are part of the exterior wall and concrete walls around the elevators and stairs. The lateral force resisting system of the addition is a ductile concrete frame, which consists of the beams and columns rigidly tied together in a manner that resists lateral motion. The addition is notable in that the two bays of the western end are open at the ground floor and serve as a drive-through to the back of the campus and as an ambulance entrance.

Seismic Characteristics of the Facility

A technical evaluation of the facility, performed in 1993 by the Hawaii State Earthquake Advisory Board, identified several seismic deficiencies. It was found that the layout of the lateral-force-resisting shear walls in the original 1972 building and the outdated pattern of column reinforcement were of the type that previously contributed to unacceptable levels of damage in similar buildings. Conditions that presented potential seismic deficiencies were also found in the 1989 addition, including:

- The eccentric location of the stair and elevator core, which could potentially create torsional response
- Inadequate connection of the floor slabs to the core, which could cause moderate damage
- The potential for nonstructural plaster cracks in the upper floors,
- The potential for local damage at the connection between new and original wings during shaking

As part of the evaluation, the torsion issue (related to the stair and elevator) was checked and found not to represent a significant problem. No specific recommendations related to the other problems were included in the evaluation. The structural evaluation concluded with a recommendation to retain a local structural engineer to review the seismic adequacy of KCH in more detail. The evaluation also covered the seismic protection of nonstructural systems and equipment, but included no specific recommendations for KCH.

The evaluation categorized nonstructural components and systems as:

- Systems and elements which are essential to hospital operations and without which the hospital cannot function (Essential)
- Nonessential elements whose failure could compromise hospital operations (Nonessential)

In fact, when considering seismic preparedness of hospital facilities, there is little consensus about the types of nonstructural systems that should be considered essential. These classifications vary from facility to facility and are closely tied to elements of the emergency response plan. For example, unbraced, suspended panelized ceiling systems typically used in hospitals on the island were noted as a deficiency, but consistent with standard seismic evaluation procedures for hospitals, these systems were classified as nonessential. However, as described below, damage to these ceilings proved critical when a real event struck.

Most of the larger equipment categorized as “essential” in the evaluation, including the emergency generator, the bulk oxygen tank, the chiller, and the rooftop cooling tower were seismically anchored and continued to function during the earthquake.

Damage

The Hawaii Earthquake of October 15, 2006, had a magnitude 6.7 and was centered about 35 miles north of the KCH. It was followed by a second shock of magnitude 6.0. The shaking caused moderate damage over much of the Big Island and was felt as far away as Oahu. Shaking on the island of Hawaii, as recorded on several instruments installed by the USGS, featured relatively high accelerations, but the energy was restricted to very high frequency (short period), which proved damaging to stiff, brittle structures. Several unreinforced masonry buildings suffered severe damage, many ungrouted stone masonry fences and walls partially collapsed, and landslides and rockslides were common, which is consistent with this kind of motion.

The Special Services Building at KCH (seen in Figure 2-35 behind the small single-story building on the left) contained such an instrument. The response spectrum for one component of motion is shown in Figure 2-36 in blue. Note the rapid decline of spectral acceleration values for very short periods, much less than 0.5 seconds. The orange curve shows a spectral shape that might be expected in association with such high ground accelerations, and is included in building codes. High values of spectral acceleration between the periods of 0.5 seconds and 2.0 seconds, as shown in this standard curve, are usually associated with much greater building damage.

Figure 2-35:
Kona Community Hospital. Addition (1989) supported on isolated columns in the foreground. The original building (1972) is in the left background.



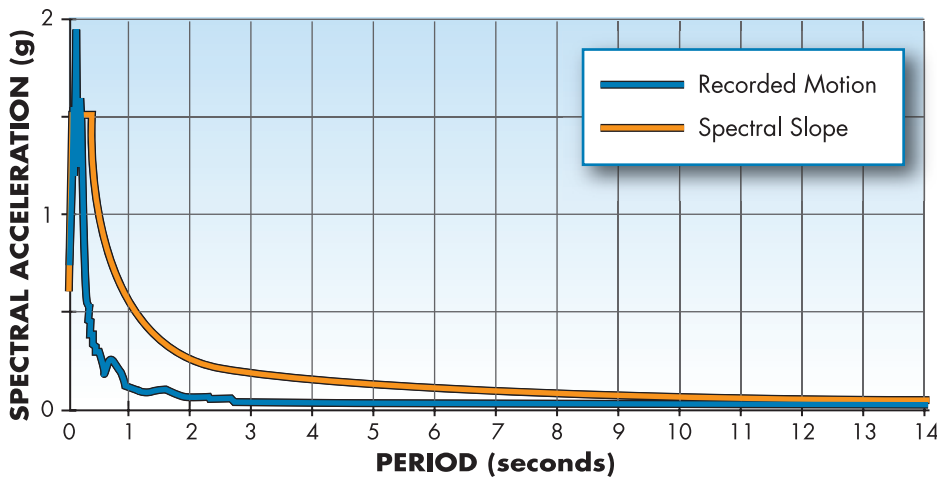

Figure 2-36: Response spectra for one of the orthogonal components recorded at the site of the KCH. The blue line is for the recorded motion. The orange line represents the spectral shape more commonly expected and contained in building codes.

(GRAPH COURTESY OF WWW.COSMOS-EG.ORG)

The high acceleration motion caused the unbraced, suspended panelized ceilings (see Figure 2-37), found almost everywhere at KCH, to strike partitions that demarcated rooms and corridors. The partitions were constructed of steel studs and gypsum board, and the studs run from the structural floor to the underside of the structure above, making them very strong and stiff. The impact of the panelized ceilings caused the light-weight support tees either to buckle or pull off of a typical perimeter trim angle (Figure 2-38). In the absence of vertical support wire, the tees collapsed, allowing the ceiling tiles to fall. Many of the florescent light fixtures, also supported on the tees, became dangerously unstable, though few fell to the floor. This type of damage was concentrated at the perimeter of rooms, adjacent to the partition walls, but it was not completely limited to these locations (see Figures 2-39). When ceiling tiles became dislodged, decades of accumulated dust on the top of the tiles came down, adding to the general disarray and threatening the health of patients and other occupants.

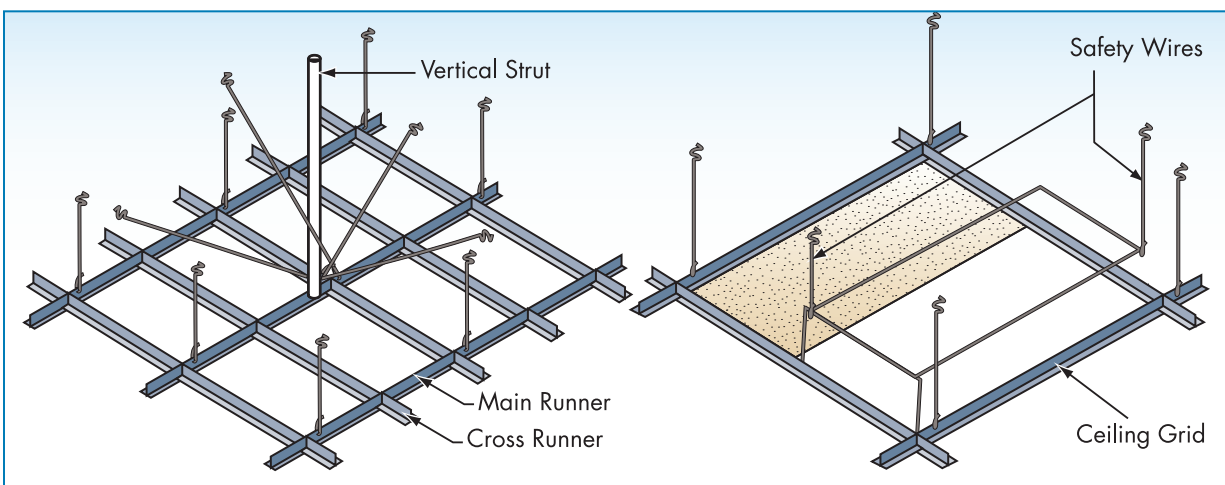

Figure 2-37: Typical suspended panelized ceiling system showing seismic bracing (according to the 1993 seismic evaluation report, this system was not used in the hospitals reviewed at that time).

Figure 2-38:

Typical damage at the perimeter of a room from loss of support from the partition-mounted perimeter angles to the ceiling system tees or from contact with the ceiling system and the partitions.



Figure 2-39:

Ceiling damage in the operating room. The round operating lights on the right were not damaged.



Almost simultaneously with the first shock, the power went out. The emergency generator was seismically protected and provided power for the emergency circuits. Eight minutes after the main shock, about the time some semblance of order was being restored, the second shock hit. With equipment and contents as well as ceiling tiles and metal tees littering the floor or hanging precariously over patients' beds, a decision was made to evacuate the most disrupted areas.

At the time of the earthquake KCH had 69 patients, including 31 in the long-term care unit. These 31 long-term care patients were taken to a local hotel; 27 patients were discharged; 5 were airlifted to an acute care

facility in Hilo, and one was transported to a local long-term care facility. The remaining five patients were more difficult to move and were placed in usable rooms in the obstetrics or the intensive care unit (ICU) on site.

The potential torsional response of the building addition, identified in the 1993 evaluation, proved prophetic, as the column-supported west end attempted to rotate around the stiffly supported east end. As shown in Figure 2-40, the two beam connections tending to restrain the motion spalled. Similarly, in the partially enclosed penthouse, the embedded connection of a steel beam spanning between two exterior concrete walls pulled out due to a stiffness incompatibility. This damage was not considered serious enough for the structure and did not affect the occupancy status.



Figure 2-40: Spalling at beam connections

Exterior and interior nonstructural plaster or stucco walls had many cracks, especially around some door frames. This damage was costly, but did not affect operations.

Emergency generators and medical gas storage were seismically anchored and survived the tremor undamaged. The communications were disrupted for the first hour or so, because the telephone main switching equipment, which was not anchored, failed. The radio-repeater mast on the roof fell over and dislodged the coaxial cable, limiting the use of that system. The hospital has subsequently decided that their radio system does not have sufficient channels for emergency use and intends to upgrade the system. Ham radio was also available on the site but was not used.

The hydraulic elevators, which are not as susceptible to damage as the traction elevators used in taller buildings, sustained no major damage but were not functional as a result of power outage. Elevators can be very valuable after earthquakes for moving bed-ridden patients, provided spe-

cial seismic anchorage and controls are installed and emergency power is available. The pressurized water systems (including sprinklers, domestic, and chilled water), considered by many the most likely to break or leak and disrupt operations, suffered no damage.

The experience of KCH highlighted the vulnerability of unbraced suspended panelized ceilings, which are often given a low retrofit priority because they are not considered a serious life safety hazard. It was also thought that the benefits of bracing do not warrant the extreme disruption that such a retrofit usually causes for hospital operations. It is very likely that lessons from Kona Community Hospital's experience will help change this view.

2.3.3 CONSEQUENCES OF BUILDING DAMAGE

The uninterrupted operation of hospitals is crucial in the aftermath of an earthquake, because of a potentially large number of casualties. Damage to these facilities and a possible need for an evacuation not only ham-

pers the emergency response but can also compound the disaster by adding casualties. The most obvious risk to life safety is serious structural failure of a hospital, similar to the experience of the original Olive View hospital. In the aftermath of an earthquake the local building authority typically determines which buildings are unsafe for use based on the level of damage. For this purpose, a simple "tagging" procedure has been developed in California that uses colored placards or "tags" affixed to buildings that show that the building has been inspected and indicate the level of safety. The evacuation is inevitable when the hospital buildings are "red tagged," i.e. when the building is in imminent danger of collapse in an aftershock. In such circumstances, a hospital becomes unavailable for emergency services and the staff can only provide medical care in parking lots or other ancillary facilities, as has happened in the past.

Even in cases where hospitals have avoided major damage, their operations may be sufficiently disrupted to require complete evacuation, which can be very dangerous for many patients. Failures in nonstructural systems, such

TAGGING



A red tag indicates **UNSAFE**: Extreme hazard, may collapse. Imminent danger of collapse from an aftershock. Unsafe for occupancy or entry, except by authorities.



A yellow tag indicates **LIMITED ENTRY**: Dangerous condition believed to be present. Entry by owner permitted only for emergency purposes and only at own risk. No usage on a continuous basis. Entry by public not permitted. Possible major aftershock hazard.



A green tag indicates **INSPECTED**: No apparent hazard found, although repairs may be required. Original lateral load capacity not significantly decreased. No restriction on use or occupancy.

as broken pipes that cause extensive flooding, failed emergency generators, lack of water, or general chaos created by contents that have been thrown about have all created conditions that have forced hospital administrators or local jurisdictions to order an evacuation. Minor nonstructural damage, especially if essential equipment or other contents are affected, can still cause considerable disruption in hospital operation, even if global evacuation is not deemed necessary.

Finally, almost all hospitals have financial constraints. The cost of repairs and/or the partial loss of capacity will affect the financial well-being of any facility and must be considered as a significant potential consequence of earthquake damage.

2.3.4 SEISMIC VULNERABILITY OF HOSPITALS

Seismic vulnerability of a hospital facility is a measure of the damage a building is likely to experience when subjected to ground shaking of a specified intensity. The response of a structure to ground shaking is very complex and depends on a number of interrelated parameters that are often very difficult, if not impossible, to predict precisely. These include: the exact character of the ground shaking the building will experience; the extent to which the structure will respond to the ground shaking; the strength of the materials in the building; the quality of construction, the condition of individual structural elements and of the whole structure; the interaction between structural and nonstructural elements; and the live load in the building at the time of the earthquake.

Frequently, seismic activity causes insignificant damage to the structure of a hospital, yet its operations are impaired or disrupted because of damage to nonstructural elements. Even a low-magnitude seismic event can affect vital functions of a hospital and cause its evacuation and closure. This was evident in some recent earthquakes, whereby structures designed in accordance with modern seismic resistance criteria performed well, while the poor performance of the nonstructural elements caused serious disruption of hospital operations.

A variety of methods for assessing seismic vulnerability of buildings exist that differ in cost and precision. The type of method to be used depends on the objective of the assessment and the availability of data and appropriate technology. Typically, quicker and less sophisticated methods, like the commonly used rapid visual screening, are used for larger areas and large number of buildings. They often form the first phase of a multi-phase procedure for identifying hazardous buildings, which must then be analyzed in more detail to determine upgrading strategies. Detailed assessment procedures use computer models and various forms of engineering

analysis that are time consuming and expensive and require a high degree of analytical expertise to obtain reliable results. Consequently, they are used for detailed verification of the safety of structural and nonstructural elements, including proposals for specific mitigation measures.

A simple preliminary vulnerability assessment of existing hospitals can be performed using the results of the historical study of hospital performance in a variety of seismic events. This method is described below in greater detail.

2.3.4.1 Seismic Vulnerability of Hospitals Based on Historical Performance in California

A recently completed study on “*Seismic Vulnerability of Hospitals Based on Historical Performance in California*,” (Holmes and Burkett, 2006) analyzed the historical record of losses to hospitals damaged in major California earthquakes since 1971. The data base contained two hundred eighteen cases, each representing a hospital (potentially one or more buildings) that experienced earthquake ground shaking in the earthquakes of San Fernando (1971), Imperial Valley (1979), Coalinga (1983), Whittier (1987), Loma Prieta (1989), Sierra Madre (1991), and Northridge (1994). Damage reports varied from brief, one-paragraph summaries to elaborate narratives of the damage patterns and the consequences. Evacuations or shut-downs of facilities were always noted. These descriptions were used to categorize hospital damage into one of the structural and nonstructural performance categories shown in Table 2-2.

Table 2-2: The description of performance categories in terms of structural and nonstructural building damage

Performance category (damage level)	Type of Structural Damage	Type of Nonstructural damage
None		
Minor	Minor structural damage (light concrete cracking, etc.)	Minor damage to nonstructural components or systems (plaster cracking, ceiling damage, some equipment shaken off supports)
Affecting hospital operations	Damage requiring immediate evacuation due to dangerous conditions or concern for collapse in an aftershock	Nonstructural damage that prevents full functioning of the hospital (loss of emergency generator, local pipe breaks and causes flooding, computer system down)
At least temporary closure	Closure could be temporary or permanent	Temporary Closure based on major nonstructural damage (long-term power or water outage, extensive ceiling and light fixture damage, major flooding)

The study related the recorded levels of damage experienced by hospitals and ground motion data for each seismic event, determined on the basis of recorded ground motion at the site during the earthquake and USGS data. The intensity of ground motion was represented by spectral acceleration at short periods (S_{DS}), measured in units of the acceleration of gravity “g” in order to match building code information that can be obtained locally (see Section 2.2.2.1). In this study, the spectral acceleration at short periods for each case in the historical record was labeled S_{HS} , which stands for historical short period spectral acceleration. By matching spectral acceleration data with performance categories, a relationship was established between the damage (and the consequences of damage) and the ground motion intensity that caused it. All buildings were divided into two groups according to the level and quality of seismic design and construction. The adoption of the HSSA in 1972 was used as a divide between pre-Act buildings and post-Act buildings. The results of this study presented the differences in performance of hospital buildings in California in graphic form on Figures 2-41 for pre-Act buildings and in Figure 2-42 for post-Act buildings.

The measure of ground motion intensity is different in the two figures. For pre-Act buildings, S_{HS} represents accelerations recorded at the time, while post-Act building performance was categorized according to ground motion expressed as the percentage of S_{DS} typically used in California for seismic design in the post-Act period. Post-Act buildings in the database were designed for the higher seismic zones of California, typically with an S_{DS} of about 1.0. To use this data to estimate potential damage to newer buildings in other parts of the country that have incorporated thorough seismic design with other values of S_{DS} , it is necessary to normalize the data to an S_{DS} of 1.0. The ground motion in Figure 2-42 is thus represented as a percentage of the S_{DS} used to design the building. “ $S_{HS} = 0.25\text{--}0.50$ of S_{DS} ” shows expected damage to a relatively new building when it is shaken with an intensity of 25 to 50 percent of its code design, as measured by S_{DS} . Since damage occurs even at levels considerably below the code earthquake, the data is still very useful for planning purposes. The probability of occurrence of shaking different from the code level can be estimated by local seismologists or engineers.

This study, based on past damages, provided a clearer picture of the vulnerability of hospitals and established a benchmark for vulnerability assessments of all the existing hospitals. Among other things, the analysis indicated that the threshold for potentially significant seismic damage coincided with the current, lower-bound ground motion intensity requiring seismic design for new buildings (S_{DS} greater than 0.167 g). The pre-Act charts indicated a slight possibility of significant structural damage, but a strong possibility of nonstructural damage at low shaking levels. It should be noted however, that structural damage requiring building closure has

been recorded even at the S_{DS} level just above 0.4 g. The analysis of the post-Act data indicated that hospital buildings built in accordance with the 2000 IBC (or later edition) are unlikely to suffer serious structural damage for events up to, and including, the intensity of the code earthquake. However, as previously discussed, new hospital buildings may not perform as well as indicated on the post-Act charts, since most regions of the country do not have as strict design and construction codes and code enforcement as California. Nonstructural damage, which can reduce hospital effectiveness or even cause evacuation, remains a significant vulnerability, even in new buildings.

2.3.4.2 Vulnerability Assessment of Hospital Buildings

Although the above-mentioned study was based on data from California, where the ground motions have slightly different characteristics than in other parts of the country, the vulnerability to damage for certain building types at given levels of ground motion is comparable to any location. Prior to obtaining the detailed site-specific seismic evaluations, the expected damage from a given ground motion can be estimated on the basis of historical data. The results of the study, therefore, can be used effectively to make preliminary assessments of the vulnerability of hospitals in any seismic region of the country. While this type of analysis will not take the place of a formal seismic building evaluation performed by experienced design professionals, it can be very helpful in raising the awareness of potential earthquake risks, in determining whether a more detailed study of vulnerability is justified, and whether to incorporate more realistic damage projections in a disaster plan or emergency exercise.

For example, a hypothetical hospital near Charleston, SC, may determine from the local building code that the seismic spectral acceleration value for short periods at the site is 0.8 g. If one or more of their buildings are 20 or more years old and were designed without seismic provisions or with out-of-date seismic provisions, the pre-Act columns of Figure 2-41 should be consulted. The chart on Figure 2-41 for the range of S_{DS} between 0.6-0.8 g shows that, unless building-specific studies are done to prove otherwise, it should be assumed that a code earthquake will cause sufficient damage to hinder the full operations (about a 33 percent chance) or require closure of a building (about a 13 percent chance). Perhaps more importantly, the right column of Figure 2-41 indicates a high probability that hospital operations will be interrupted by nonstructural damage. In fact, for such a facility, even very low shaking levels of S_{DS} 0.2 g to 0.4 g could be expected to cause nonstructural damage resulting in significant disruption of hospital operations.

In contrast, a brand new hospital in northern Utah, on a site with S_{DS} of about 0.7 g, is unlikely to suffer significant structural damage (as shown on the post-Act charts, left column of Figure 2-42). However, if such a hospital was not constructed according to the best design and construction standards, it can be expected to suffer a more significant nonstructural damage than the post-Act data shown in Figure 2-42. A prudent disaster plan would in such a case consider the possibility that nonstructural damage could cause a temporary closure.

2.3.4.3 Comparability of Hospital Buildings

The structural performance of hospital buildings built anywhere in the country without any seismic design provisions is most likely comparable to the performance of pre-Act buildings as shown on Figure 2-41. All buildings in the pre-Act group were either constructed with no seismic design, or with the archaic seismic design rules of the 1960s or earlier. Most of these buildings were constructed with concrete, steel, reinforced masonry, or wood construction. Unreinforced masonry buildings are rare in California because most of these buildings have either been abandoned or retrofitted. However, it should be assumed that older buildings of unreinforced masonry bearing wall construction, that are still common in other parts of the country, would perform at the low end of the ranges recorded for pre-Act buildings.

Buildings with seismic designs completed in the 1970s and 1980s can be expected to perform somewhere between pre- and post-Act levels, but probably closer to the pre-Act data. Buildings classified as post-Act are exceptionally strong, because the designs were thoroughly checked and the construction monitored in detail. Due to the State-of-California-mandated scrutiny given design and construction, there are few hospital buildings outside of that area that would be equivalent to the post-Act category. However, the structural performance of hospitals built since the early 1990s that incorporated full seismic design, including an importance factor of 1.5, can be compared to the post-Act category.

The vulnerability assessment of existing hospitals with respect to nonstructural building components is different from the assessment of potential structural damage. Unless a significant emphasis was placed on the design and installation of nonstructural anchorage and bracing, and unless the construction was monitored and inspected regularly, the potential for damage to ceilings, partitions, pipes, ducts, equipment, and other nonstructural systems should be estimated using the pre-Act column and charts. Since it is unlikely that nonstructural systems have been adequately protected in areas outside of California, it is recommended to assume that

PRE-ACT BUILDINGS

Structural Damage to Pre-Act Buildings

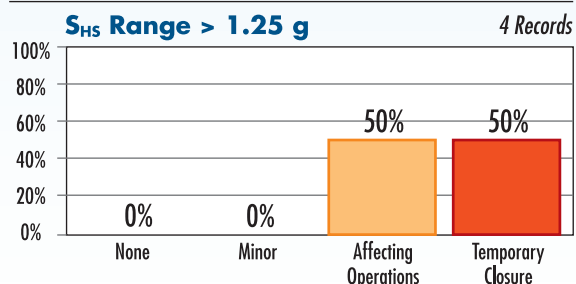
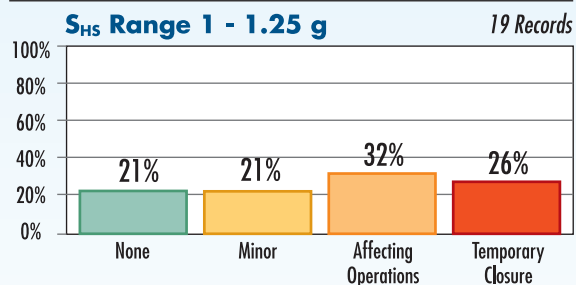
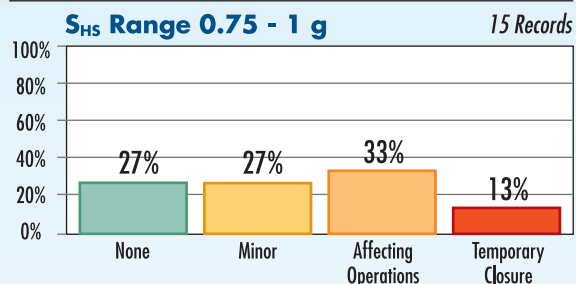
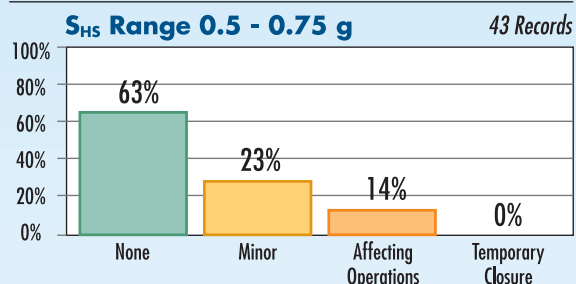
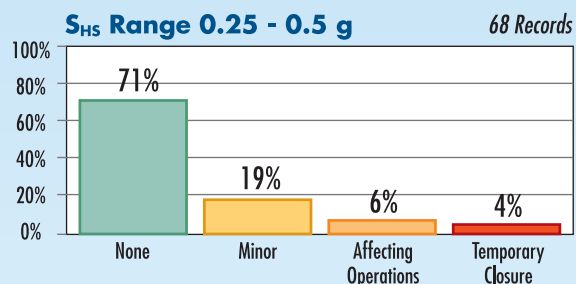

Nonstructural Damage to Pre-Act Buildings

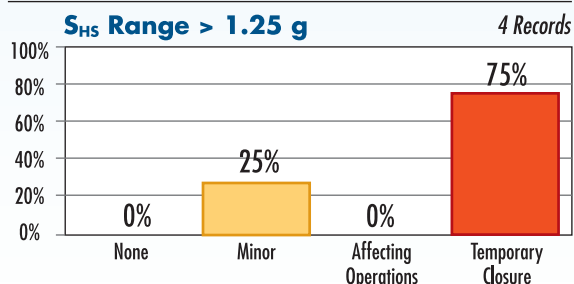
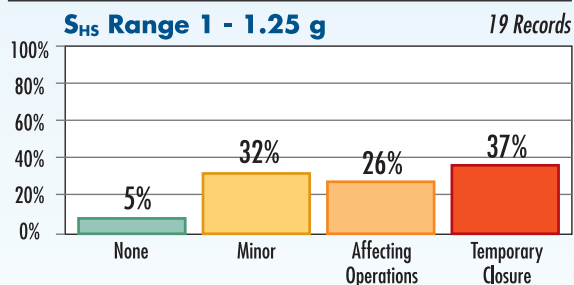
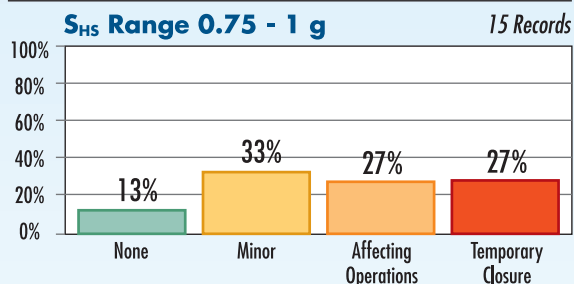
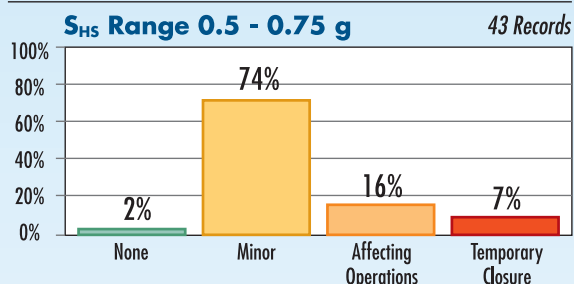
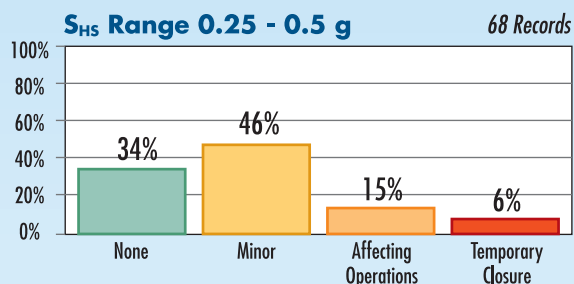
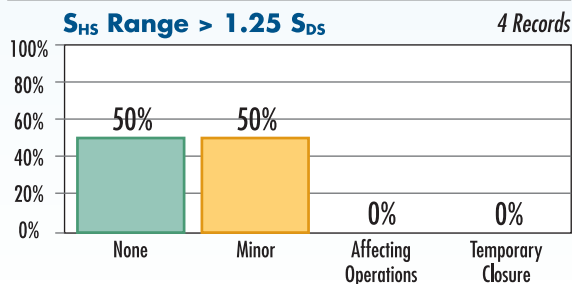
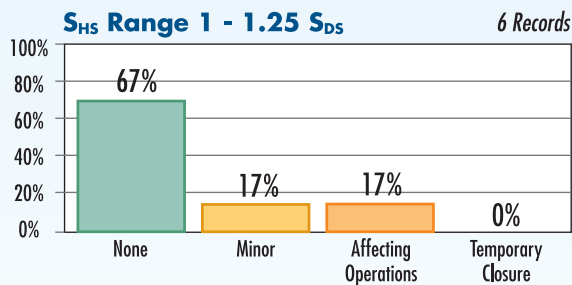
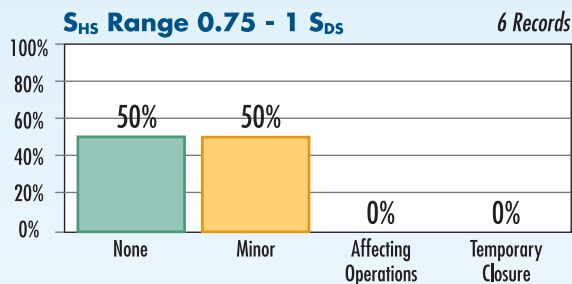
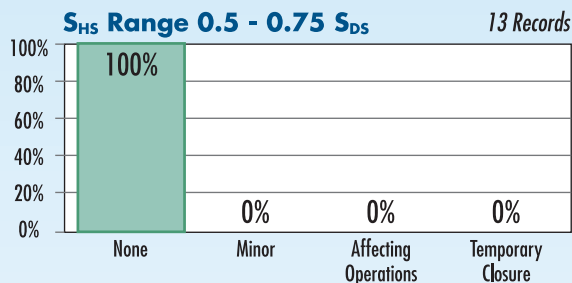
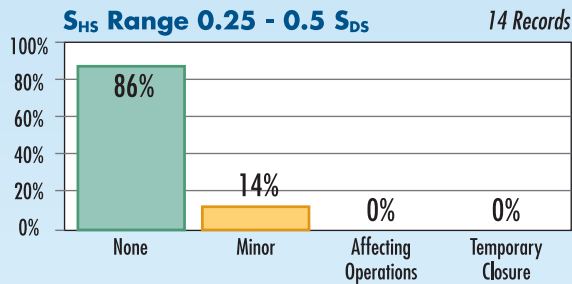

Figure 2-41: Charts showing performance categories for pre-Act buildings for various ground motions

POST-ACT BUILDINGS

Structural Damage to Pre-Act Buildings



Nonstructural Damage to Pre-Act Buildings

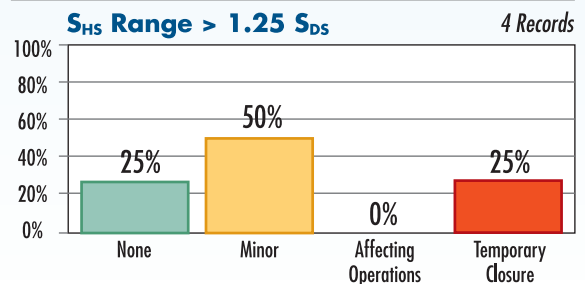
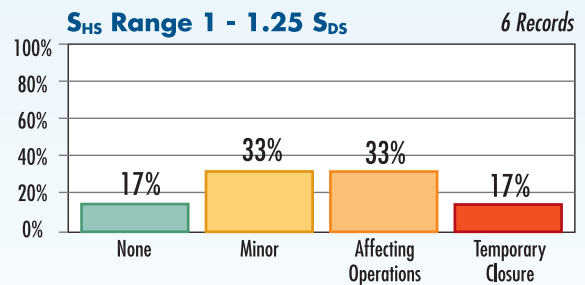
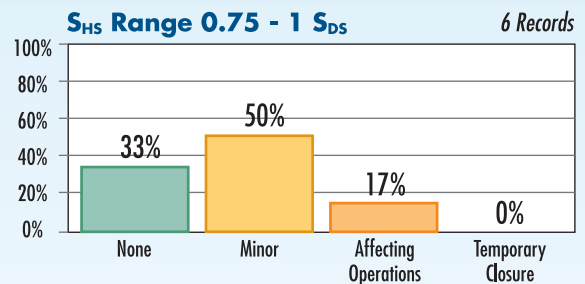
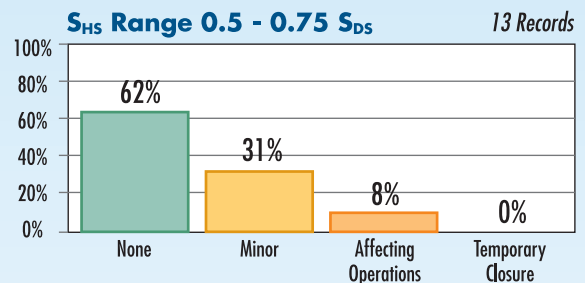
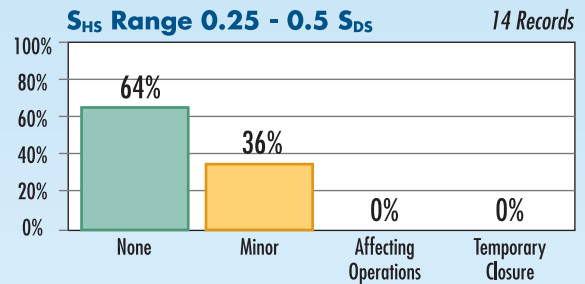

Figure 2-42: Charts showing performance categories for post-Act buildings for various ground motions

substantial damage to these systems would be a certainty in moderate to high levels of shaking. Even with the extraordinary measures taken in California to assure thorough seismic protection of nonstructural systems, the level of nonstructural damage recorded indicates that the potential disruption of hospital operations can happen at shaking of about 50 percent S_{DS} . The shaking above 80 percent S_{DS} would most likely result in nonstructural damage that would require immediate closure and total evacuation of the hospital.

This type of vulnerability analysis should be used for preliminary assessments or for the purpose of awareness training or emergency planning. It cannot replace a formal seismic building evaluation performed by experienced design professionals. The type and the extent of seismic risk exposure for hospitals can only be identified by expert analysis.

2.4 RISK REDUCTION MEASURES

This section outlines some of the basic approaches and techniques of mitigating earthquake hazards. Since the theory and practice of seismic design are well established and have largely been incorporated into the current model building codes, this section starts with the review of basic steps in the process of planning and design of hospitals. It also highlights some of the well-established seismic design and construction techniques and specialized building systems designed specifically to address the seismic forces. Although the general principles of design are similar for new and existing hospitals, this section highlights the differences in code requirements and overall project delivery processes that reflect the opportunities and constraints of seismic design for new and existing buildings.

2.4.1 SITE SELECTION BASICS

The first priority for owners of existing hospitals and planners and designers of new facilities is to understand the seismic hazard risk. The location and the physical characteristics of the site determine the extent of seismic hazards, which include the potential intensity of ground shaking, the possibility of liquefaction, earthquake induced landslide, or more rarely, the potential of a tsunami or seiche. If ground motion is the only or predominant hazard, site seismicity can be determined from the local building code by a local structural engineer or a building department official. More detailed information can be obtained from the USGS Web site, which provides seismological information for any zip code in the nation. When hazards in addition to ground motion exist, seismic experts are needed to determine the probability and extent of these risks and possible mitigation techniques.

The selection of hospital sites is generally based more on factors associated with availability of land, proximity to service area, cost, convenience of access for patients, visitors, and staff, or general demographic con-

cerns than on the exposure of these sites to natural hazards, particularly earthquakes. Careful site selection, however, is a critical first step in risk reduction, because the potential ground motion from a single earthquake may vary considerably depending on the nature of the soil and the distance of the site from known earthquake faults. A large medical center that is developing a plan for new multi-building facility should include comprehensive analysis of the site characteristics and its exposure to natural hazard as an important factor in evaluating alternative sites.

- Consider seismic constraints in site selection. Although it would be very rare for a hospital district to make a site selection decision based solely on seismic risk, moving a hospital even a few miles in some cases can make a big difference to its exposure to seismic hazard. An example is locating a hospital 5 to 10 miles away from a major earthquake fault, rather than locating it within 1 mile of the fault.
- Locate the building on a soil type that reduces the risk. Local soil profiles can be highly variable, especially near water, on sloped surfaces, or close to faults. In an extreme case, siting on poor soils can lead to damage from liquefaction, land sliding, or lateral spreading of the soil.
- Since hospitals should be designed to performance-based criteria that include minimum disruption and continued operation, the location of the site within the region may play a critical role in achieving the required performance. The definition of “site” becomes the region within which the facility is located, and assessments should be made with respect to its access to materials, personnel, and utilities, as well as its position in the regional transportation grid.

In most cases, however, it is probable that a site with optimal characteristics (other than seismic considerations) will be selected and that seismic issues will be mitigated as part of planning and design of the facility. A proposed construction site located directly over a fault is probably the only location characteristic that would lead to rejection of an otherwise suitable site.

2.4.2 SEISMIC DESIGN BASICS

Minimum standards and criteria for seismic design are defined in the seismic section of building codes. The codes provide maps that show whether the location is subject to earthquakes and, if so, the probability of occurrence, expressed by varying levels of seismic forces for which a building must be designed. The seismic provisions in building codes are adopted by State or local authorities, so it is possible for a seismically-prone region to be exempt from seismic building code regulations if the

local community decides that the adoption of such provisions is not required. Hospital board officials and designers should not ignore seismic design requirements irrespective of whether local communities have adopted seismic code regulations or not.

Budgeting extra costs for seismic design is a difficult issue, because although the risk may appear to be minimal, the effects could be catastrophic if a significant event were to occur. The very fact that such an event is rare means that the community may have no history of designing for earthquakes, and the building stock in general would be especially vulnerable. Hospital buildings are an important community resource (along with other essential buildings, such as schools and fire and police stations) that must be protected as much as possible.

2.4.3 STRUCTURAL SYSTEMS

Health care facilities occupy buildings of different sizes, configurations, and structural systems. Additionally, hospitals differ in the level of services they provide. Some hospitals are distinguished by high occupancies, while others emphasize outpatient services. The mixture of functions and services is such that hospitals frequently require building systems that can accommodate very diverse functions. These can vary from acute care with many diagnostic, laboratory, and treatment areas requiring high-tech facilities and services to support functions such as laundry, food service, receiving, storage, and distribution.

Smaller healthcare facilities may encompass one or more of these functions, such as predominantly longer residential care, or specialized treatment such as physical rehabilitation or dialysis. This functional variety may influence some structural choices, but the structure, as in all buildings, plays a primary role in providing a safe and secure support for the facility activities. Since continued operation is the preferred performance objective, structural design that goes beyond life safety standards is necessary, which requires special attention.

2.4.3.1 Basic Types of Lateral Force Resisting Systems

Figure 2-43 shows the basic types of structural lateral force resisting systems. These systems compose the three basic alternatives for providing lateral resistance: shear walls, braced frames, and moment-resistant frames. Each of these has specific characteristics, such as stiffness, relationship to spatial requirements, and cost-effectiveness that must be evaluated for each project. Diaphragms connect horizontal and vertical elements and transfer the seismic loads to the lateral force resisting

system. This concept is shown in Figure 2-43. Structural material alternatives—steel, reinforced concrete, reinforced concrete masonry, and wood, provide further options that must be evaluated. Figures 2-44, 2-45, and 2-46 show the three systems and materials that can be used to resist seismic forces in more detail.

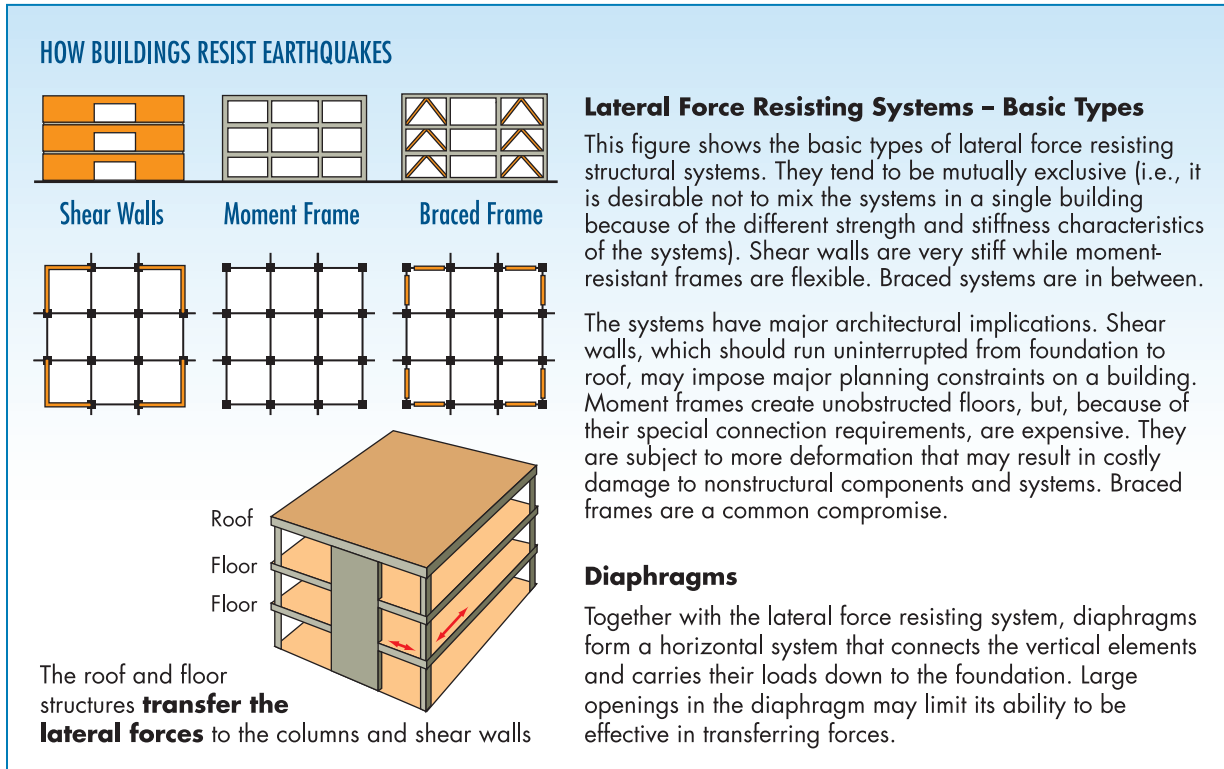
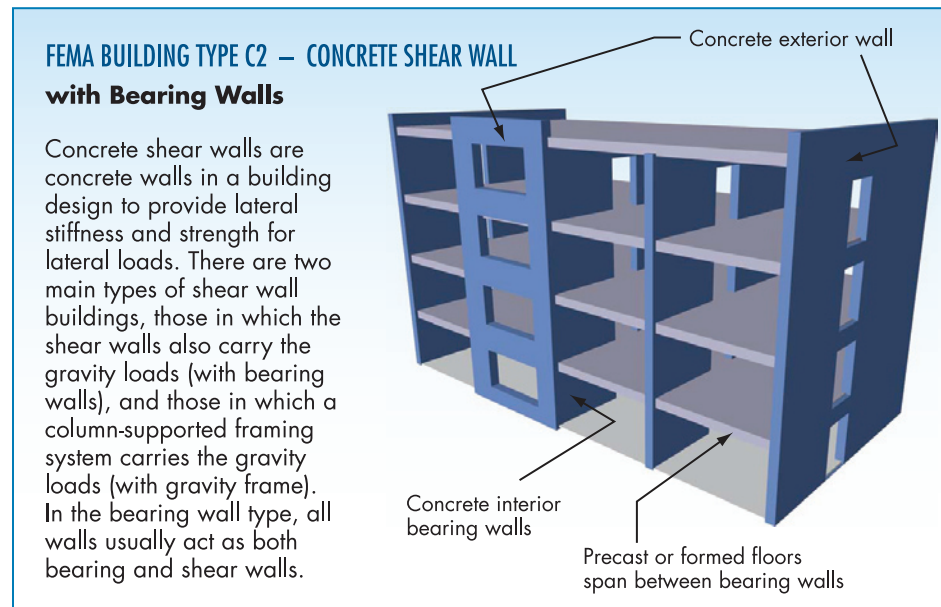

Figure 2-43: Basic types of lateral force resisting systems

SOURCE: BSSC: PRESENTATIONS TO THE ARCHITECTURAL COMMUNITY, 2001, CHRIS ARNOLD AND TONY ALEXANDER

Figure 2-44:
Reinforced concrete
shear wall structure



FEMA BUILDING TYPE S2 STEEL BRACED FRAMES

These buildings consist of a frame assembly of steel columns and beams. Lateral forces are resisted by the diagonal steel members placed in selected bays. Floors are cast-in-place concrete. These buildings are typically used for buildings similar to Steel Moment Frames, although are more often low rise.

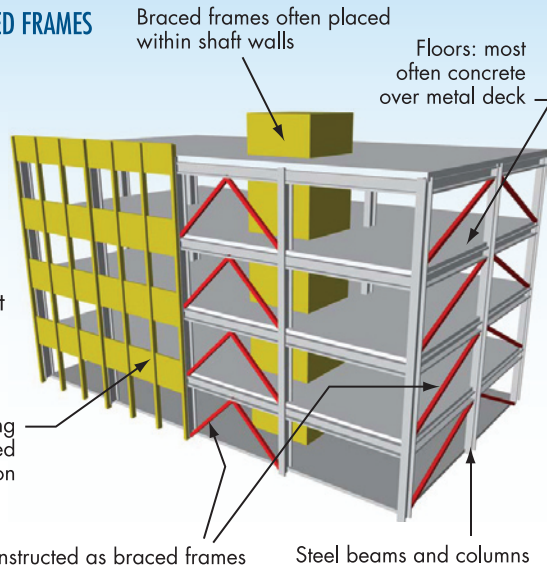

Figure 2-45:
Steel braced frame structure

FEMA BUILDING TYPE S1 – STEEL MOMENT FRAMES

These buildings consist of an essentially complete frame assembly of steel beams and columns. Lateral forces are resisted by moment frames that develop stiffness through rigid connections of the beam and column created by angles, plates, and bolts, or by welding. Moment frames may be developed on all framing lines or only in selected bays. It is significant that no structural wall are required. Floors are cast-in-place concrete or slabs or metal deck and concrete. The building is used for a wide variety of occupancies such as offices, hospitals, laboratories, academic and government buildings.

The S1A building type is similar but has floors and roof that act as flexible diaphragms such as wood or up-topped metal deck.

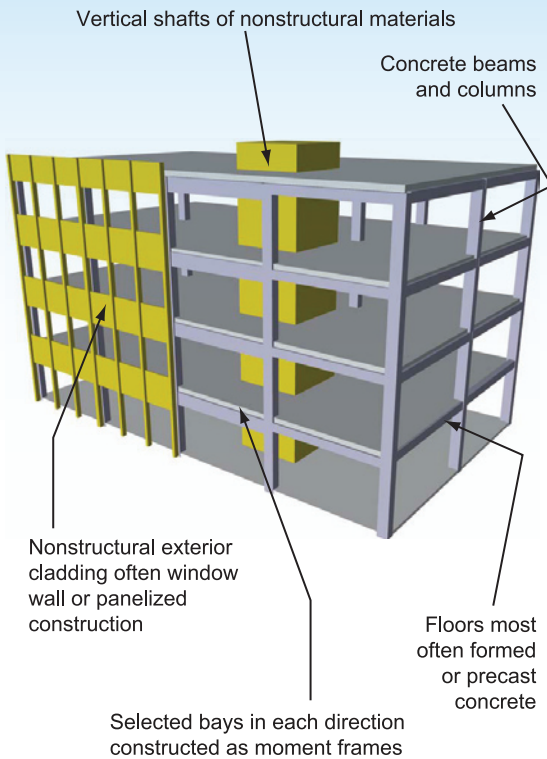

Figure 2-46:
Steel moment resistant frame

Many variations of these types are possible, together with other structural types such as wood frame, light steel, reinforced masonry, and tilt-up reinforced concrete. The seismic codes expand these three basic systems into six categories by the addition of two categories of dual systems (composite steel and reinforced concrete) and inverted pendulum systems (such as cantilevered water tanks).

For each of the three basic systems, four coefficients and factors are provided, of which the most unique is the response modification, or “R” factor. This is a coefficient related to the overall behavior and ductility of the structural system. R has values from 1.25 to 8, and is a divisor that modifies the base shear value obtained in the ELF procedure by reducing the design forces. The higher the number assigned to R, the greater the reduction. Thus, the highly ductile and better-understood moment-resisting frame has a value of 8, while an unreinforced masonry structure has a value of 1.5. Using the R reduction is justified because experience and research confirm the expected performance of these systems and their ability to accept overloads.

2.4.3.2 Innovative Structural Systems

In recent years, a number of new approaches to the seismic protection of buildings have been developed that are now seeing increased use. These systems depend on modifying either the seismic loads that are transmitted from the ground to the building, or the building response. In both instances, the strategy is to let the building “ride with the punch,” rather than relying on resistance alone to protect the building.

Seismic isolation, generally referred to as *base isolation*, is a design concept that reduces the earthquake motions in the building superstructure by isolating the building from ground motions. This is accomplished by supporting the building on bearings that greatly reduce the transmission of ground motion (see Figure 2-47). Both the structure and the nonstructural systems are subjected to reduced shaking levels, so the system is well suited for essential facilities, like hospitals that need to remain functional following an earthquake. Many emergency management centers and a few hospitals in the United States have employed this technique. It has also been used by private industry on buildings of high importance, and as a retrofit technique, mostly for significant historic buildings.

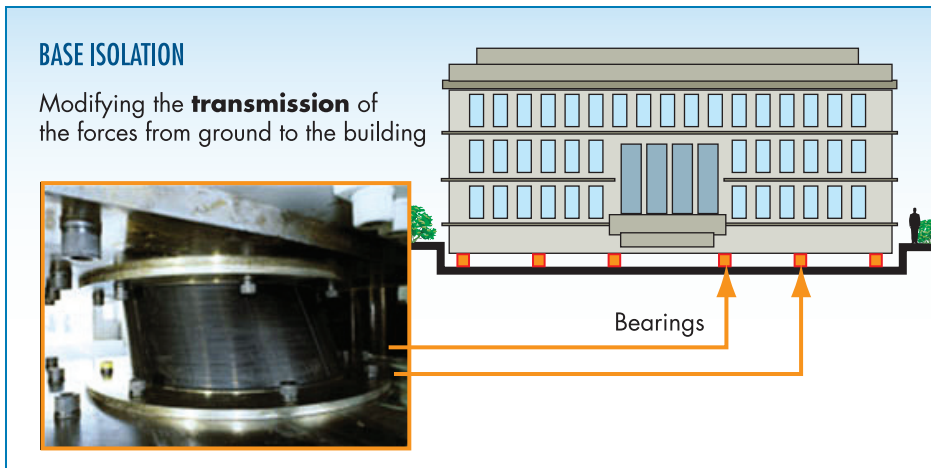

Figure 2-47:
Seismic isolation

Passive energy dissipation is another concept in which the earthquake forces in the building are reduced by the introduction of devices that are designed to dissipate the earthquake energy in a controlled manner using friction, hydraulics, or deformation of material specially placed for this purpose (see Figure 2-52). These devices usually take the form of a bracing system that connects the vertical structural members together. These devices also increase the damping of the structure and reduce the drift. The Bremerton Naval Hospital provides an example of successful rehabilitation that used these devices (see Section 2.4.6.2).

2.4.3.3 Structural Systems Selection

The seismic code prescribes the analysis procedures for a number of different types of structural systems. The engineer, however, must choose the system that is appropriate for the type of building and its use. Structural systems vary greatly in their performance attributes, even though they may all meet the requirements of the seismic code if correctly designed and constructed.

The critical initial step in selecting a structural system is to establish performance goals for the project. Because hospitals are classified as essential buildings, the seismic code requirements imply a requirement for a certain level of performance. An informed performance-based design procedure is necessary. This procedure should involve the owner, the full design team, and any other stakeholders. The process should cover all steps, from determining performance goals to the detailed design and construction of the project.

On the technical side, the most important measure of good earthquake-resistant design is the effect on the structure after the earth has stopped

shaking. With little building damage, there is a good chance that the building will be functional and repair costs will be low. With significant damage, it is unlikely that the building would be functional and repair or replacement costs would be high. The measure of success in seismic design of a hospital is the extent to which a building can avoid significant damage and retain a reasonable level of functionality without the need to evacuate patients. The behavior of each structural system and building configuration differs with earthquake ground motions, soil types, duration of strong shaking, etc., but past observations of damage can inform the decisions about the most appropriate systems.

The best performing structural systems will do the following:

- Possess stable cyclic behavior. Will not be prone to sudden structural failure or collapse
- Control lateral drift. Will keep drift (lateral distortion between floors) to reasonable dimensions to reduce damage to nonstructural components, such as glazing, partitions, and cladding
- Dissipate seismic energy without failing. Absorb the earthquake energy in a controlled manner without causing structural members to fail
- Create a good chance of functionality and a low post-earthquake repair cost

2.4.4 NONSTRUCTURAL COMPONENTS AND SYSTEMS

For a long time, seismic building codes focused exclusively on the structural components of building. Although this focus still remains dominant, experience in recent earthquakes has shown that damage to nonstructural components and systems is also of great concern. Continued hospital operation is increasingly dependent on nonstructural components and systems, including medical and building equipment. Hospital operations also depend on specialized services, some of which involve storing of hazardous substances, such as pharmaceuticals, toxic chemicals, oxygen, and other gases, that must be protected against spilling. Distribution systems for hazardous gases must be well supported and braced. Unlike most buildings, hospitals require a very extensive plumbing network to supply water throughout the building, and an adequate piping network to supply water for fire sprinklers, which increases the risk of secondary water damage in case of failure of these systems during earthquakes.

In a typical hospital, not only do the nonstructural components play a major role in operations, they also account for large share of the cost. Typically, for a medium-size hospital, the structure accounts for around 15 percent of the total cost, and the nonstructural components for the remaining 85 percent. Of the latter, the mechanical, electrical, and plumbing systems alone account for approximately 35 percent of the total building cost.

Even though the building structure may be relatively undamaged after an earthquake, excessive structural motion and drift may cause damage to ceilings, partitions, light fixtures, service piping, and exterior walls and glazing. In addition, storage units, medical equipment, and filing cabinets may topple and cause injuries if not properly anchored or braced. Excessive drift and motion may also lead to damage to rooftop equipment, and localized damage to water systems and fire suppression piping and sprinklers. Heavy equipment, such as shop machinery, kilns, and heavy mechanical and electrical equipment, may also be displaced and become non-functional.

2.4.4.1 Code Regulated Nonstructural Systems

The seismic code categorizes nonstructural components as architectural components or mechanical and electrical components. Many of the hospital contents, such as furnishings and specialized equipment, which may be critical to hospital function, are not subject to regulation.

Table 2-3 shows the list of nonstructural components and systems that are subject to code regulation.

Table 2-3: Code Regulated Architectural, Mechanical, and Electrical Components

Architectural Components	Mechanical and Electrical Components
Interior Nonstructural Partitions	General Mechanical
Plain unreinforced masonry	Boilers and furnaces
Other walls and partitions	Pressure vessels
Cantilever Elements, Unbraced	Stacks
Parapets	Cantilevered chimneys
Chimneys and stacks	Other
Cantilever Elements, Braced	Manufacturing And Process Machinery
Parapets	General
Chimneys and stacks	Conveyors (non-personnel)
Exterior Nonstructural Wall Elements	Piping Systems
Wall elements	High deformability
Body of panel connections	Limited deformability
Fasteners of connecting systems	Low deformability

Table 2-3: Code Regulated Architectural, Mechanical, and Electrical Components (continued)

Architectural Components	Mechanical and Electrical Components
Veneer	HVAC System Equipment
Limited deformability	Vibration isolated
Low deformability	Non-vibration isolated
Penthouses, Not Part of Main Structure	Mounted in-line with ductwork
Ceilings	Other
Cabinets	Elevator Components
Storage cabinets and lab equipment	Escalator Components
Access Floors	Trussed Towers (Free-standing or Guyed)
Special access floors	General Electrical
All others	Lighting Fixtures
Appendages and Ornamentation	
Signs and Billboards	
Other Rigid Components	
High deformability elements	
Limited deformability elements	
Low deformability elements	
Other Flexible Components	
High deformability elements	
Limited deformability elements	
Low deformability elements	

Figure 2-48 is an example of a cable tray with a braced support system designed in conformance with the seismic code.

Figure 2-48:
Seismically braced
cable tray support

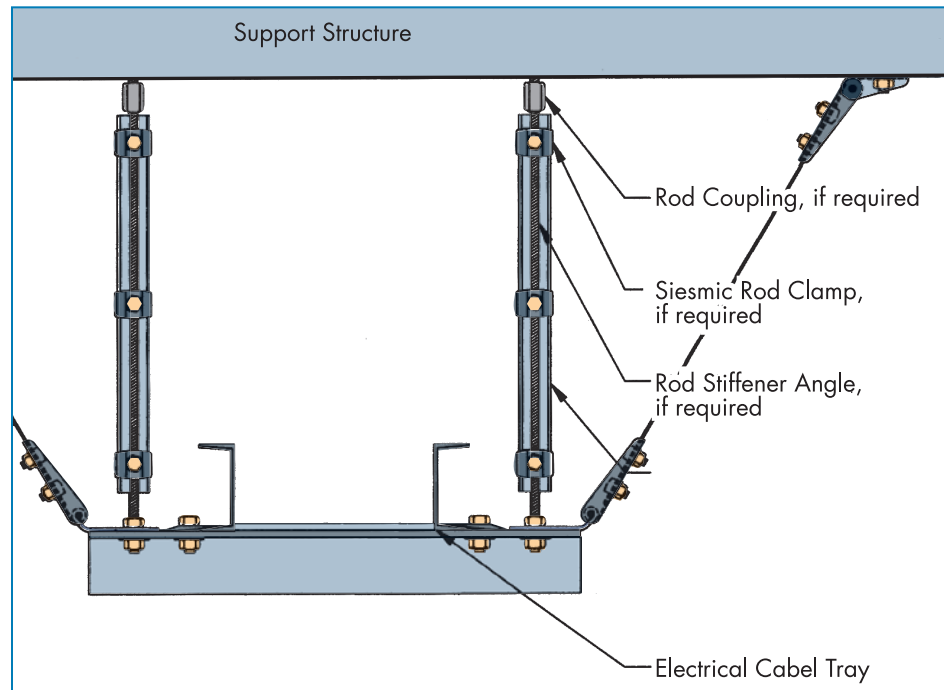

2.4.4.2 Interstitial Space for Utility Installations

Developments in medical technology frequently require hospitals to add or re-route utility and medical services infrastructure and add electrical capacity to various parts of the building, often with consequent disruption of the operations and difficulties caused by limited available space above the ceiling. In response to these problems, a number of hospitals have been designed with interstitial service space. In some designs, the interstitial floor is a nonstructural floor hung from the structural floor above (Figure 2-49).

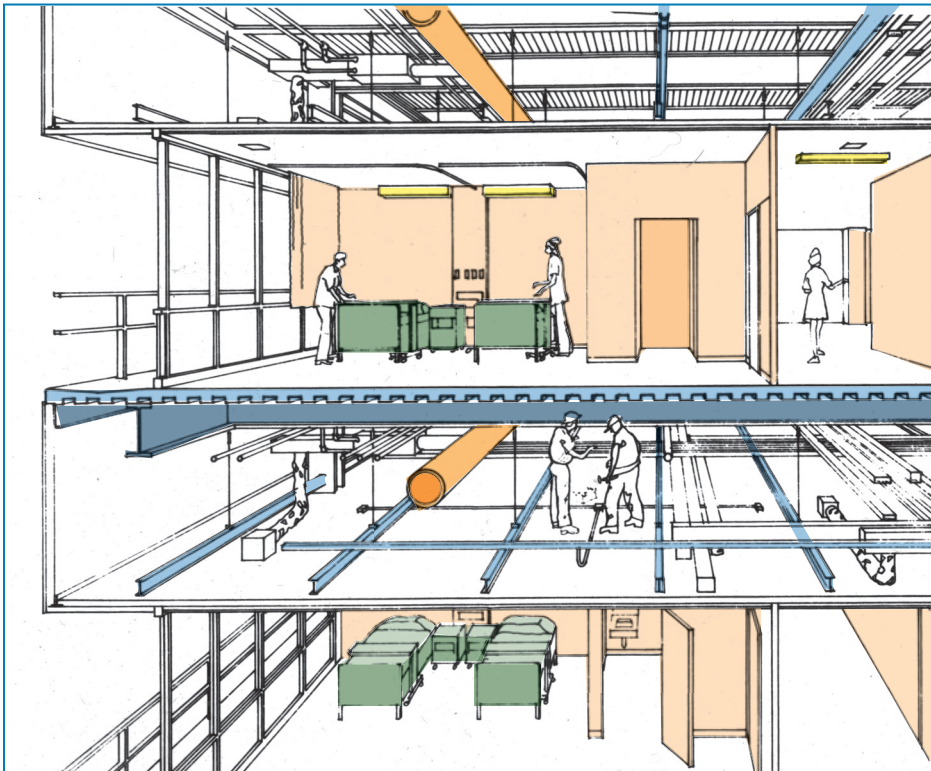

Figure 2-49:
Interstitial floor system
hung from the floor
above

The interstitial space concept provided a full floor above the functional space where service personnel can work to add or modify installations without disturbing the space below, or disrupting hospital operations. The main structural effect of an interstitial floor is to increase the floor-to-floor height of the occupied floors and the building as a whole, with some increase in the amount of structural material. Any of the common steel and concrete frame systems can be used to provide the interstitial floor arrangement. The interstitial space concept was used in the Loma Linda Veterans Hospital (see Section 2.4.5.1)

2.4.5 MITIGATION MEASURES FOR NEW BUILDINGS

If mitigation measures are instituted in the planning stage, a high level of seismic protection can be achieved in a new building with the following steps:

- Assure that the latest model building code is used, using the appropriate importance factor.
- Include provisions in the design to allow the facility to function on its own for 4 days. This would require storage of sufficient fuel for emergency standby power supply system, reserve water supply, and provisions for waste water storage. Assure that access to the site will not be impaired by earthquake damage.
- Although seismic isolation should be considered for all buildings that are intended to be functional after an earthquake, this measure should be considered as a realistic alternative only for sites with S_{DS} over 0.8 g.
- Consider a peer review of the structural design, particularly in jurisdictions that do not require a thorough plan check to obtain a building permit. A peer review is essential if innovative structural systems, such as isolation or structural dampers, are used.
- Assure that the seismic design for nonstructural elements and systems regulated by the building code are the responsibility of the design team. A list of such responsibilities is given in FEMA 356. One method of gaining such assurance is to create the position of a Nonstructural Seismic Coordinator (NSC), whose responsibility is to review the specifications, drawings, or other methods proposed to attain adequate seismic anchoring and bracing of all systems. Further, the NSC will follow the submittals and construction processes to assure appropriate implementation.
- Put in place a comprehensive system to monitor construction quality and to track significant change orders that might imply subtle reductions in structural or nonstructural seismic performance.

2.4.5.1 The Case of Loma Linda Veterans Hospital

The 500-bed Veterans Administration Hospital in Loma Linda, CA, opened in September 1977. Designed as a replacement facility for the Veterans Administration Hospital lost in the 1971 San Fernando earthquake, it was built in the area of extremely high seismicity, and represents an interesting case of careful seismic design.

The project was remarkable because of the extent to which the configuration of a large and complex building was influenced by seismic design concerns. At the same time, the project provides a lesson in showing that early recognition of seismic design determinants by the whole design team, and a serious interdisciplinary approach from the inception of design, can enable requirements of both seismic design and hospital planning and economy to be achieved with equal effectiveness.

The San Bernardino Valley is seismically very active, and the final site selected for the new hospital had 11 known active faults within a 65-mile radius, including the San Jacinto fault and two segments of the San Andreas fault. The potentially active Loma Linda fault was also believed to be located near the site, and after intensive studies, it was concluded that the most likely location of the fault was 200 to 400 feet southwest of the site, but that surface rupture at the site was not likely. The risk of soil amplification was significant.

The consultants recommended that design earthquakes of magnitude 8+ and duration of 35–40 seconds on the San Andreas fault, and magnitude 6.5–7.25 and duration of 20 seconds on the San Jacinto fault, should be considered. The building structure was to be designed for a peak acceleration of 0.5 g, while the essential and potentially damaging nonstructural components were to be designed for an acceleration of 2.0 g.

Some of the design force determinants evaluated were dependent on a building configuration concept.

1. **Site geometry:** The large 40-acre site enabled the designers to consider a freestanding building unconstrained by site geometry. The site area was sufficiently large to allow consideration of a relatively low, horizontally planned building.
2. **Design Program:** Research studies on hospital organization and planning had established some general benefits of horizontal planning—defined as plans in which clinical and diagnostic areas are placed on the same floor as nursing areas, rather than being concentrated into a base structure with a vertical connection to the bed-related functions. Experience in vertically planned hospitals had indicated some problems in ensuring adequate circulation, since the concentration of vertical circulation into a single tower tended to result in over- or under-capacity, depending on the time of the day. There were also indications of a general preference by staff for horizontal movement over vertical, and an indication that a reduction of vertical circulation for severely ill patients would be desirable.

3. **Aesthetics:** The design of hospitals tends to be dominated by the solution of very complex planning, service, and equipment problems, and appearance tends to be a secondary concern. The city of Loma Linda was anxious that the setting of the hospital should be “park-like.” In response to this desire, and to the generally small scale of the immediate site surroundings, the image of a low, nonassertive building, placed toward the center of the site, seemed appropriate. Although very large in size, the building’s relatively low height and the considerable size of the site was to help reduce the visual effect of the building on the neighboring community
4. **Building system:** The Loma Linda Hospital was intended as a demonstration of the Veterans Administration Hospital Building System, which had been developed over a period of several years by the same team that was responsible for the hospital design. The building system consisted of a carefully conceived set of design concepts intended to rationalize and organize the preliminary hospital design.

The structural design comprised moderate-span simple post and beam shallow floor framing system, large floor-to-floor heights, and lateral force resistance elements concentrated in the service tower at the end of each of the service modules. The planning and aesthetic requirements of a low, deep plan building coincided well with a stiff seismic design that would minimize story drift; consequent architectural, mechanical, electrical, and contents damage; and loss of operational capability. In addition, the low, stiff building would have a shorter period and possibly a lower response than the projected response spectra peaks of 0.3 and 0.8 seconds from the two nearby faults. The only way of moving the building response well away from the ground response would be to develop a flexible high-rise structure that would be undesirable from all the other viewpoints considered.

The chosen configuration was the simplest of all those studied: a simple block, almost square in plan, with no basement and with a symmetrical pattern of four courtyards within the block. The courtyards were relatively small. The plan had an even distribution of shear walls throughout, running uninterrupted from roof to foundation and having direct continuity in plan with the structural framing members.

The planning and circulation of the building were carefully related to shear wall layout to achieve minimum shear wall penetration with clearly defined, highly accessible public and departmental planning. The eight service towers (four at each end) provided a location for major shear walls. Each tower provided two shear walls in the east-west direction and one in the north-south direction.

The general lateral resisting system used concrete shear walls and a ductile moment-resistant “backup” frame. The stiff primary shear wall system was designed for a high force level, so that the structure will tend to have low lateral deflections for the design earthquakes described earlier. The calculated maximum story-to-story drift was well within presently accepted desirable ranges for hospitals.

The backup frame was intended to form a stable and reliable backup system for lateral force resistance and redistribution of forces should one or more of the shear walls become seriously damaged. The chances of the backup frame being forced to work to its full capacity were considered small, but considering the size and importance of the facility, and the uncertainties of estimating the nature of ground motion, the possibility could not be ignored.

Shear walls were always placed at the perimeter of service modules to minimize interference. Interior girders were dropped below the beams to minimize interference with plumbing service and to allow beam continuity across the module. As a result of the service organization, all beams and girders are free of penetrations. These framing characteristics were the product of the research study that determined the system’s design.

The shear walls are collocated with frame lines. The advantages of this arrangement were:

- Beams or girders were always parallel and lined up with the walls, to serve as lateral force collectors.
- The continuation of these members through the wall allowed direct transfer of forces from the diaphragm to the wall.
- The columns at the end of walls formed the required ductile flange members.
- Frame members were in the correct position to provide vertical support for shear wall dead loads.

Complete calculations and designs were completed for all nonstructural components and systems. The bracing of utility distribution systems, ceilings, partitions, and lights was made easier and less expensive by the presence of the interstitial floor system shown in Figure 2-49.

2.4.6 MITIGATION MEASURES FOR EXISTING BUILDINGS

Engineering of structural and nonstructural risk reduction measures is similar for new and existing hospitals. New hospital design offers the possibility to minimize the risk by selecting a site subject to less ground motion, with better soil conditions, or located farther from a fault. It can be designed with the most appropriate structural system, using known and tested materials and a good building configuration. These possibilities are not available when retrofitting an existing hospital. The existing building may have been designed to an obsolete seismic code or no code at all, its materials may be questionable, or the building configuration and structural system may be inappropriate. Therefore, protecting an existing hospital must start with a detailed evaluation of its vulnerability, because seismic retrofitting is both disruptive and expensive, and should not be implemented without careful study.

2.4.6.1 Procedures and Design Strategies for Rehabilitation of Structural Systems

Additions to an existing hospital must meet all the code requirements for a new building. With the exception of California, there are currently no seismic codes that apply to the retrofit of existing hospitals. Typically, the standards to be applied are derived from the code for new buildings and negotiated with the applicable building department. It is generally recognized that it is difficult, or almost impossible, to bring an existing structure to full compliance with a current code, and so some compromises have to be made. There is, however, no general agreement as to how the code for new buildings should be applied to the retrofit design of existing ones.

FEMA has developed many such documents and several have been adopted by ASCE as standards suitable for adoption by building codes (see ASCE 31 and ASCE 41). The planning process for retrofits should begin with an evaluation procedure, such as Tier 1 of the ASCE 31 *Seismic Evaluation of Existing Buildings* (ASCE, 2003). If the evaluation results require a retrofit of an existing building, ASCE 41, *Seismic Rehabilitation of Buildings* (ASCE, 2007) is the authoritative source document and can be used to help a hospital design team select seismic protection criteria. The architect and engineer can also use the document for the design and analysis of the seismic rehabilitation project.

ASCE 41 provides methods and design criteria for several different levels of seismic performance. The document also recommends a thorough and systematic procedure for performance-based seismic design, intended to produce a design responsive to the owner's level of acceptable risk and

available resources. This process starts with a requirement to select specific performance goals (Rehabilitation Objectives) as a basis for design. In this way, users can directly determine the effect of different performance goals on the design requirements, including their complexity and cost. See Section 2.2.3 for a further description of performance-based seismic design.

Typical basic design concepts for improving the structural seismic performance of an existing hospital include:

- Modifying and improving local components or materials, such as beam/column connections. This involves retrofitting connections and strengthening structural members by such methods as adding, reinforcing, or replacing them with new components.
- Adding new lateral force resisting elements, such as shear walls or braced frames.
- Removing or reducing configuration irregularities. This involves providing seismic separations in irregular configurations, or adding shear walls or bracing to reduce torsional effects. Mass can also be removed by removing stories.
- Modifying the basic seismic response of a structure by adding dampers or installing seismic isolation systems.

2.4.6.2 The Case of Naval Hospital Bremerton

Naval Hospital Bremerton, located in Bremerton, WA, not only serves military personnel and their families in the area—up to 60,000 people—but could also be called on to serve more than 250,000 people on Washington’s Kitsap Peninsula after a major earthquake. The facility is spread over 40 acres, and includes 20 buildings, some of which are 70 years old. Being one of only two major hospitals in the region, the Navy was concerned about its response capability to moderate-to-strong seismic ground shaking expected at the site (Wilson, 2005).

To obtain a broad understanding of the vulnerability of the facility and the relative risk among the many buildings, a rapid visual screening was completed by the Navy’s consultant, Reid Middleton, using FEMA 154 (FEMA, 2002), which considers structural type, basic seismic characteristics, building use, and occupancy load. This relatively modest effort provided an overview of the seismic risk at the campus, as well as a preliminary relative ranking among buildings. It made it obvious that the main hospital building, a nine-story, 250,000-square-foot building that housed most of the essential medical functions, should be a priority (see Figure 2-50).

The building is a steel moment frame, constructed in the 1960s, that employed welded beam-to-column connections, now known to be prone to cracking when subjected to large seismic deformations. A more detailed structural analysis and evaluation was performed using FEMA 356 (FEMA, 2000). It was found that although the frame does not pose a significant threat of collapse, the building's ability to function after an earthquake could be severely limited by damage to structural joints, and by nonstructural damage.

In February 2001, while the Navy and the design team were considering their options, the Magnitude 6.8 Nisqually earthquake struck the area. The earthquake occurred deep below the surface and approximately 30 miles from the site. The ground motions at the site were below the design shaking for the site, but nevertheless caused significant nonstructural damage—particularly in the upper floors (see Figure 2-51). Such nonstructural damage always causes concern about the integrity of the structure—and often requires destructive exploration to verify. Based on preliminary structural inspections, aided by recordings of the response from instruments in the building, the Navy decided to stay in the building while more extensive exploration and analysis were performed. It took several months before nonstructural repairs were completed and the building returned to full use. Subsequent structural review indicated no structural damage.

Figure 2-50:
The main building
at Naval Hospital
Bremerton

SOURCE: REID MIDDLETON,
INC.





Figure 2-51:
Disruption in the upper floors at Naval Hospital
Bremerton from the Nisqually earthquake

SOURCE: REID MIDDLETON, INC.

The data on the response of the building to the Nisqually earthquake provided an opportunity to simulate, by computer analysis, a design event. This simulation revealed that shaking at the design level could cause unacceptable damage, both to the beam-column joints and to nonstructural systems. The team found that traditional, code-based retrofits, such as local modification of the 1,550 beam-column connections, or introduction of braced frames to meet current standards, were too costly and disruptive. Solutions were investigated using the more finely tuned, performance-based design methodologies of FEMA 356, and a more innovative scheme, based on the introduction of supplemental seismic dampers, appeared feasible.

Several styles of dampers are available for use in buildings, including those employing controlled yielding of steel elements, those based on friction (similar to a brake shoe), and more sophisticated hydraulic dampers (similar to a shock absorber). Dampers are normally placed in a building in a configuration similar to diagonal braces, and work against the movement between floors (see Figure 2-52). This action reduces inter-story drift and, to a lesser extent, reduces floor accelerations that cause sliding and overturning of equipment and contents. Although dampers should be evenly distributed throughout the building, they allow greater flex-

ibility in placement than braced frames or other standard lateral force resisting systems. The flexibility in placement of the dampers means that critical locations, those that would reduce usefulness of the intended space or cause operational shutdowns during installation, can be avoided. Using performance-based design concepts, the team set the target structural performance levels for Immediate Occupancy (see Section 2.2.3.1) for the design earthquake shaking, and Collapse Prevention for a reasonable estimate of the worst shaking expected at the site. Structural analysis indicated that adding a total of 88 fluid viscous dampers, spread through the facility, would deliver the desired performance within the bounds of the current analysis and prediction capability. The cost of the structural retrofit was projected to be less than 10 percent of the replacement cost, a value that would yield a favorable life cycle cost (from damage avoided) on most sites in the country.

Figure 2-52:
Installation of dampers
at Naval Hospital
Bremerton. The
configuration is similar
to steel braced frames.

SOURCE REID MIDDLETON,
INC.

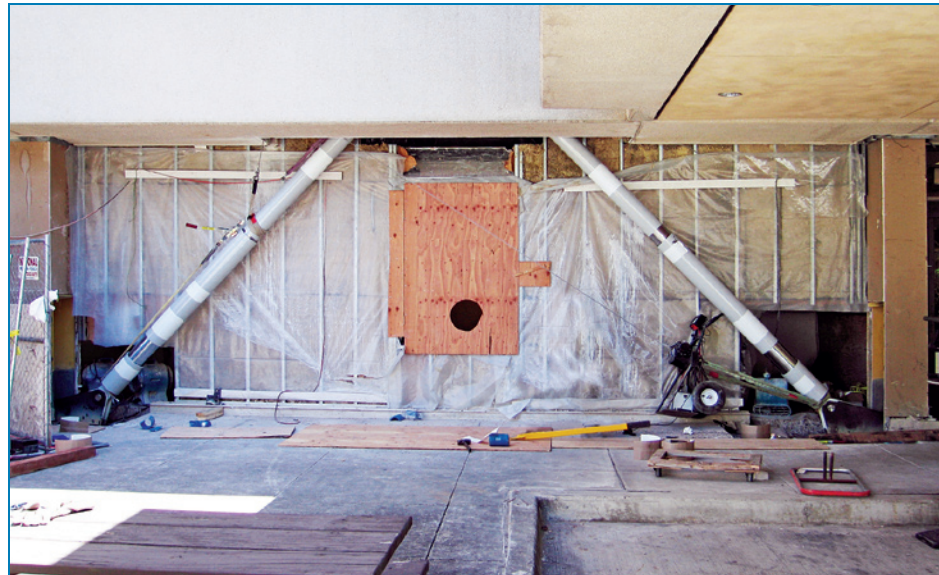

In parallel with the retrofit design, the team developed an inexpensive and innovative program (called REACH—Rapid Evaluation and Assessment CHecklist) to improve the speed and effectiveness of future building safety evaluation following a seismic event. For many structural types, the seismic structural damage is covered and not obvious; concern about the extent of structural damage can sometimes delay decisions about building safety, or even cause an unneeded evacuation. The building-specific REACH program incorporates real-time data from the building's seismograph network. Threshold values for acceleration and displacement are pre-determined by the design team, and actual building motion is then compared with these threshold values to allow more accurate and informed decisionmaking regarding the ability of the building to sustain the safe delivery of medical services after earthquakes. The REACH checklist contains additional information, such as a description of the structural

system, structural drawings, recommended structural inspection sites, and other information of use to the facility engineer and building inspectors. The REACH documents are stored in the facility department's disaster response locker, and are reviewed by facility staff during routine emergency drills.

Recognizing the significant effect that damage to nonstructural systems can have on post earthquake functionality, the facility has begun retrofit of nonstructural elements, including bracing of acoustic tile ceiling and light grids, mechanical system piping, as well as cabinetry and furniture. Future analysis and reinforcement of bracing for critical equipment (such as radiology and laboratory) is planned.

2.4.6.3 Procedures and Design Strategies for Rehabilitation of Nonstructural Systems

Complete, nonstructural seismic rehabilitation of an existing hospital in operation is disruptive and very expensive. However, it is relatively easy to incorporate seismic bracing and anchoring during ongoing renovation or rehabilitation work. A more active and aggressive program requires developing databases of components and systems, and developing a process for prioritizing. Priorities can be set by considering importance to life safety, importance to overall functionality, associated cost and disruption, component vulnerability, or by cost-benefit considerations (see FEMA 274 for more information).

Components commonly found to be of high priority because of their importance, high level of vulnerability, and relatively low cost include anchorage of standby generators, medical gas storage, pressurized piping, and communications systems. Although not normally considered a dangerous or high-priority system, damage to lightweight suspended panelized ceiling and light systems can disrupt hospital operations, as happened in Hawaii where such damage forced the KCH to evacuate (see Section 2.3.2.2). It is important that the key vulnerabilities of each facility be identified and considered in emergency planning and mitigation programs.

2.4.6.4 Summary of Risk Reduction Measures for Existing Buildings

Achieving cost-effective improvements in seismic performance of existing facilities is far more complex than improving expected performance for proposed new buildings in the planning and design stage. First, and most obvious, it is always far less expensive to include relatively small changes in a new design to create seismically resistant structural and nonstructural

systems than it is to retrofit—or sometimes replace—existing systems. The complexity and expense of retrofitting is exacerbated when such work is not done in conjunction with complete renovation—that is, if the building has to remain mostly occupied and operational.

Following the recommended seismic evaluations, careful analysis is needed to identify significant life safety risks from potential structural collapse; to identify and achieve short-term, high benefit-cost mitigation measures; and to plan for longer-term overall mitigation. The following steps are recommended:

- Engage a structural engineer experienced in seismic evaluation and design to perform a seismic structural evaluation of existing buildings on the campus that contribute to the hospital function. The primary purpose of such an analysis is to quickly identify buildings that may be seriously damaged or even collapse in a code-level earthquake. A secondary purpose is to gain an understanding of the probable performance of the structural and nonstructural systems of each building by using the data charted in Figures 2-41 and 2-42.
- Engage an architect, mechanical and electrical engineer, and structural engineer, as needed, to evaluate the probable seismic performance of nonstructural components and systems.
- Update the emergency response plan, considering the results of the seismic evaluations.
- If significant life safety risks are identified from review of either structural or nonstructural systems, make plans to minimize occupancy of the building, replace the building, or retrofit to an acceptable level of performance.
- In most cases, shaking of less than code intensity, which may cause minor or no structural damage, can cause serious nonstructural damage. The most vulnerable elements that can affect the functions of the hospital have been identified from past earthquakes. They are the emergency generator, the bulk oxygen storage tank, the internal and external emergency communication systems, and the patient elevators. These elements, other than the elevators, normally can be anchored and braced against seismic damage rather inexpensively and quickly. The elevators may require extensive retrofit to assure operation after strong shaking. However, to assure safe patient relocation immediately after an event, it is recommended that one patient elevator serving each floor be retrofitted to at least the capacity of the structural system and to current standards for essential facilities. Automatic seismic switches that demobilize elevators at low

shaking levels should be used with caution, as the switch may defeat the purpose of the strengthened elevator.

- Mechanical equipment on vibration isolators that are not designed for seismic forces are extremely vulnerable to seismic damage. This equipment should be identified and fitted with appropriate anti-seismic isolators, or seismic snubbers, as soon as possible.
- Nonstructural elements affected by or exposed by normal renovation should be upgraded to current standards.
- The expected seismic structural performance of all buildings on the campus should be considered as part of master planning. Planning should also consider opportunities to provide 4 days of self reliance, (See Section 2.4.5).
- Vulnerable medical buildings that can lose full functionality after a code earthquake should be studied for retrofit or replacement. Improvements in seismic structural performance can often be combined with major renovations. Adjacent additions can sometimes be made sufficiently strong to buttress an existing building.
- Incremental seismic rehabilitation, as described in FEMA 396 (2003), should also be considered for applicability.
- An emergency plan that considers the care of the patients and staff of the facility, as well as the surrounding community, should be kept up to date and should include a realistic estimation of the seismic performance of the structural and nonstructural systems in each building, and on the site in general.
- The Hospital Seismic Safety Evaluation Checklist (Table 2.4) should be applied.

2.5 CHECKLIST FOR SEISMIC VULNERABILITY OF HOSPITALS

The Checklist for Seismic Vulnerability of Hospitals (Table 2-4) is a tool that can be used to help assess site-specific seismic hazards and building vulnerability. The checklist is useful during site selection, preliminary design of a new building, or when considering rehabilitation of an existing facility. In addition to examining building design issues that affect vulnerability, the checklist also helps users to examine the functionality of the critical and emergency systems upon which most hospitals depend. The checklist is organized into separate sections, so that each section can be assigned to a subject expert for greater accuracy of the examination. The results should be integrated into a master vulnerability assessment to guide the design process and the choice of appropriate mitigation measures.

Table 2-4: Hospital Seismic Safety Evaluation Checklist

Vulnerability Sections	Guidance	Observations
Site Condition		
Is there an active fault on or adjacent to the site?	If suspected, site-specific geologic investigations should be performed. Consult local building department, State geologist, local university, or local geotechnical expert.	
Does the site consist of soft, stiff, or dense soil or rock?	If the presence of softer soil that can lead to force amplification or liquefaction is suspected, site-specific geologic investigations should be performed.	
Are post-earthquake site egress and access secured?	Alternative routes—unlikely to be blocked by falling buildings, power lines, etc.—are desirable.	
Are utility and communications lifelines vulnerable to disruption and failure?	Security of the entire utility and communications network is the issue: the facility may be affected by offsite failures.	

Table 2-4: Hospital Seismic Safety Evaluation Checklist (continued)

Vulnerability Sections	Guidance	Observations
Site Condition (continued)		
Are there alternate or backup sources for vital utilities such as water and power?	Redundant systems increase the probability of the hospital remaining functional after an event.	
Architectural		
Is the architectural/structural configuration irregular?	Irregular vertical and horizontal configurations, such as set backs, open first stories, or L- or T-shaped plans, may lead to significant stress concentrations.	
Is the building cladding attached to structural frames so that it can accommodate drift?	Frames are flexible, and cladding must be detailed to accommodate calculated drifts and deformations. If waterproofing of these systems is compromised, rain following an earthquake could cause parts of the building to be closed.	
Are heavy veneers, such as brick or stone, securely attached to the structural walls?	Shear wall structures are very stiff and carry large earthquake forces; heavy attachments must be securely attached.	
Are glazing and other panels attached so that they can accommodate drift?	Glazing must be installed with sufficient bite and adequate space between glass and metal to accommodate drift	
Are light, suspended grid ceilings and lights braced and correctly attached at walls?	Suspended ceilings, if not braced, easily distort (particularly in light and flexible frame structures), thus causing ceiling panels to fall out.	
Are heavy plaster suspended ceilings securely supported and braced?	Heavy lath and plaster ceilings in older facilities are very dangerous if poorly supported.	
Are partitions that terminate at a hung ceiling braced to the structure above?	Partitions need support for out-of-plane forces, and attachment to a suspended ceiling grid only is inadequate.	
Are masonry or hollow tile partitions reinforced, particularly those surrounding exit stairs?	Heavy partitions attract strong earthquake forces because of their stiffness and mass, and are prone to damage. They are particularly dangerous around stairs and exit ways.	
Are parapets and other appendages securely braced and attached to the building structure?	Unreinforced masonry parapets are especially vulnerable. Brace items such as cornices, signs, and large antennas.	
Structural System		
When was the existing structure designed?	Buildings with no, or outdated, seismic design are unlikely to perform adequately in strong shaking. Verify that the Importance Factor was used in design.	

Table 2-4: Hospital Seismic Safety Evaluation Checklist (continued)

Vulnerability Sections	Guidance	Observations
Structural System (continued)		
Has the local seismic zoning changed significantly since the building was designed?	Local expectation of shaking intensity can change as scientific knowledge increases	
Is there a continuous load path from all components of the building to the foundation?	A continuous load path assures that the structure will act together as a whole when shaken. Connections from walls to floors and roofs should also form part of this load path.	
Is all load-bearing structural masonry reinforced according to code?	Older unreinforced masonry has proven very vulnerable in strong shaking.	
Are horizontal diaphragms correctly designed and constructed with necessary chords and collectors?	Large diaphragm openings and the edges of diaphragms need careful design to ensure forces are properly transmitted to walls and frames.	
Nonstructural Systems		
Are there backups for critical municipal utilities?	Municipal utilities such as water, power, and gas, are often disrupted in strong shaking. Onsite backups should provide 48 hours of use.	
Are ducts, piping, conduit, fire alarm wiring, and communication systems that pass through seismic joints provided with flexible connections?	Differential movement between sections of the building can cause breakage and leaks in pipes and ducts if no provision is made for movement. If walls at joint are firewalls, penetrations should be fireproofed.	
Is heavy mechanical equipment adequately secured?	Heavy equipment may slide and break utility connections.	
Are vibration isolators for vibrating equipment designed for seismic forces?	Equipment may jump off very loose isolators and may break restraints designed for wind only.	
Is the piping properly braced and provided with expansion joints?	See Section 2.4.4.	
Is ductwork properly supported and braced?	See Section 2.4.4.	
Are boilers and other tanks securely braced?	Gas heaters or tanks with flammable or hazardous materials must be secured against toppling or sliding.	
Are plumbing lines adequately supported and braced?	Leaks in pressure pipes can cause damage over a large area. Protection of joints is especially important. See Section 2.4.4.	
Is fire protection piping correctly installed and braced?	See Section 2.4.4.	

Table 2-4: Hospital Seismic Safety Evaluation Checklist (continued)

Vulnerability Sections	Guidance	Observations
Nonstructural Systems (continued)		
Is heavy electrical equipment adequately secured?	Switch gear and transformers are heavy and sliding or movement failure can shut down the electrical system. See Section 2.4.4.	
Is emergency generator and associated equipment secured against movement?	The generator, muffler, batteries, day tank, and other electrical equipment may be necessary for emergency operation. See Section 2.4.4.	
Are suspended lighting fixtures securely attached, braced, or designed to sway safely?	Older suspended lighting fixtures have performed badly in earthquakes, and are an injury hazard. See Section 2.4.4.	
Are light fixtures supported in an integrated ceiling, braced, and provided with safety wires?	Light fixtures within a grid often fall when the grid is distorted, unless the fixtures are secured with safety wires. See Section 2.4.4.	
Are the elevator cars, counterweights, and equipment anchored for seismic forces?	Elevators are important for patient movement, particularly in an emergency. After strong shaking, elevators and shafts should be checked for safety before use. See Section 2.4.4.	
Is at least one elevator in each wing connected to the emergency power system?	Even if properly anchored and undamaged, the elevator needs power to enable vertical patient movement. See 2.4.4.	
Is the bulk oxygen tank and associated equipment secured?	The legs, anchorage, and foundations of large tanks need to be checked for adequacy.	
Is nitrogen storage secured?	Loose tanks may fall and break connections.	
Are small natural gas lines to laboratories or small equipment vulnerable?	Incompatibility of large and small lines and equipment movement can cause dangerous leaks.	
Is the fire alarm system connected to a secondary power supply?	This is also necessary to support daily operational needs, including lighting, heating, communications, etc.	
Is significant fire alarm equipment secured against movement?	Equipment can slide or topple, breaking connections. See FEMA 74.	
Communications and IT Systems		
Are communications components, including antennas, adequately braced and supported?	Post-event communications are vital for post-earthquake operations. See FEMA 74.	
Are plans in place for emergency communication systems, both within the facility and to outside facilities?	Planning must consider likely post-earthquake conditions at the site and offsite.	

2.6 REFERENCES AND SOURCES OF ADDITIONAL INFORMATION

Note: FEMA publications may be obtained at no cost by calling (800) 480-2520, faxing a request to (301) 497-6378, or downloading from the library/publications section online at <http://www.fema.gov>.

ASCE, 2003, *Seismic Evaluation of Existing Buildings*, ASCE Standard ASCE-31, American Society of Civil Engineers, Reston, VA.

ASCE, 2005, *Minimum Design Loads for Buildings and Other Structures*, ASCE Standard ASCE-7-05, American Society of Civil Engineers, Reston, VA.

ASCE, 2007, *Seismic Rehabilitation of Buildings*, ASCE Standard ASCE-41, Reston, VA.

Arnold, Christopher, and Michael Durkin, 1983, *Hospitals and the San Fernando Earthquake*, August 1983, Building Systems Development, Inc., Palo Alto, CA.

Behr, R.A., 2004, "Design of Architectural Glazing to Resist Earthquakes," Proceeding, 13th World Conference on Earthquake Engineering, Vancouver, BC, August 2004.

Earthquake Engineering Research Institute (EERI), John F. Hall, Technical Editor, 1995, "Chapter 11, Nonstructural Damage, Northridge Earthquake of January 17, 1994 Reconnaissance Report," Volume 1, *Earthquake Spectra, Supplement C to Volume 11*, April 1995, Earthquake Engineering Research Institute, Oakland, CA.

Federal Emergency Management Agency (FEMA), 1997a, *NEHRP Guidelines for the Seismic Rehabilitation of Buildings*, FEMA 273, Federal Emergency Management Agency, Washington, DC.

FEMA, 1997b, *NEHRP Commentary on the Guidelines for the Seismic Rehabilitation of Buildings*, FEMA 274, Federal Emergency Management Agency, Washington, DC.

FEMA, 2000, *Prestandard and Commentary for the Seismic Rehabilitation of Buildings*, FEMA 356, Federal Emergency Management Agency, Washington, DC.

FEMA, 2002, *Rapid Visual Screening of Buildings for Potential Seismic Hazards, A Handbook*, FEMA 154, Federal Emergency Management Agency, Washington, DC.

FEMA, 2003, *Incremental Seismic Rehabilitation of Hospital Buildings*, FEMA 396, Federal Emergency Management Agency, Washington, DC.

FEMA, 2007, *Designing for Earthquakes, A Manual for Architects*, FEMA 454, Federal Emergency Management Agency, Washington, DC.

Holmes, William T., 2002, "Background and History of the Seismic Hospital Program in California," Proceedings, 7th U.S. National Conference on Earthquake Engineering, July 21-25, 2005, Boston, MA, Earthquake Engineering Research Institute, Oakland, CA.

Holmes, William T. and Lawrence Burkett, 2006, "Seismic Vulnerability of Hospitals Based on Historical Performance in California," Proceedings, 8th U. S. National Conference on Earthquake Engineering, April 18-22, 2006, San Francisco, CA, Earthquake Engineering Research Institute, Oakland, CA.

Lew, H. S., E. V. Leyendecker, and R. D. Dijkers, 1971, *Engineering Aspects of the 1971 San Fernando Earthquake*, Building Science Series 40, U. S. Department of Commerce, National Bureau of Standards, Washington, DC.

Los Angeles County, Department of Health Services (LACDHS), 1994, *Report to the California Hospital Building Safety Board's Special Forum on Damage to Health Facilities in the January 17, 1994 Northridge Earthquake*, Minutes of the California State Hospital Building Safety Board, April 12, 1994, Office of Statewide Health Planning and Development, Sacramento, CA.

National Oceanic and Atmospheric Administration (NOAA), Leonard Murphy, Scientific Coordinator, 1973, *San Fernando, California Earthquake of February 9*, Volume 1, Part A, U.S. Department of Commerce, NOAA, Washington, DC.

Precast/Prestressed Concrete Institute (PCI), 1989, *Architectural Precast Concrete*, 2nd. Edition, PCI, Chicago, IL.

URS Consultants (URS), 1996, *Northridge Earthquake Study of Seismic Design Factors for Hospital Non-Structural Components*, Office of Statewide Health Planning and Development, Sacramento, CA.

Wang, M.L., 1987, "Cladding Performance on a Full-Scale Test Frame," *Earthquake Spectra*, EERI, Vol. 3, No. 1, pp. 119-173, February 1987.

Wilson, Douglas, Kent Russell, Stephen Stanek, and David Swanson, 2005, "Strong Medicine" pp 26-29, *Modern Steel Construction*, Volume 45, Number 2, American Institute of Steel Construction, Chicago, IL.

Whole Building Design Guide, *Seismic Design of the Building Envelope*, National Institute of Building Sciences, Washington, DC, 2006.

3.1 GENERAL DESIGN CONSIDERATIONS

This chapter introduces the physical nature and mechanics of floods and explains how flood probabilities are determined and how flood hazard areas are identified. It describes the types of flood damage that can result when hospitals are located in flood hazard areas or are affected by flooding. A series of requirements and best practices are introduced that facility owners, planners, and designers should consider for reducing the risks from flooding to new hospitals and to existing facilities located in areas prone to flooding.

This chapter demonstrates why avoidance of flood hazard areas is the most effective way to minimize the life-safety risk to patients, staff, and the citizens who rely on these facilities, as well as to minimize the potential for damage to buildings and other elements of hospitals. When an existing facility is exposed to flooding, or if a new facility is proposed to be located in a flood hazard area, steps need to be taken to minimize the risks. A well-planned, designed, constructed, and maintained hospital should be able to withstand damage and remain functional after a flooding event, even one of low probability.

3.1.1 THE NATURE OF FLOODING

Flooding is the most common natural hazard in the United States, affecting more than 20,000 local jurisdictions and representing more than 70 percent of Presidential disaster declarations. Several evaluations have estimated that 7 to 10 percent of the Nation's land area is subject to flooding. Some communities have very little flood risk; others lie entirely within the floodplain.

Flooding is a natural process that may occur in a variety of forms: long-duration flooding along rivers that drain large watersheds; flash floods that send a devastating wall of water down a mountain canyon; and coastal flooding that accompanies high tides and onshore winds, hurricanes, and nor'easters. When this natural process does not affect human activity, flooding is not a problem. In fact, many species of plants and animals that live adjacent to bodies of water are adapted to a regimen of periodic flooding.

Flooding is only considered a problem when human development is located in areas prone to flooding. Such development exposes people to potentially life-threatening situations and makes property vulnerable to serious damage or destruction. It also can disrupt the natural surface flow, redirecting water onto lands not normally subject to flooding.

Flooding along waterways normally occurs as a result of excessive rainfall or snowmelt that exceeds the capacity of channels. Flooding along shorelines is usually a result of coastal storms that generate storm surges or waves above normal tidal fluctuations. Factors that can affect the frequency and severity of flooding and the resulting damage include:

- Channel obstructions caused by fallen trees, accumulated debris, and ice jams
- Channel obstructions caused by road and rail crossings where the bridge or culvert openings are insufficient to convey floodwaters
- Erosion of shorelines and stream banks, often with episodic collapse of large areas of land
- Deposition of sediment that settles out of floodwaters or is carried inland by wave action
- Increased upland development of impervious surfaces and manmade drainage improvements that increase runoff volumes
- Land subsidence, which increases flood depths
- Failure of dams (resulting from seismic activity, lack of maintenance, flows that exceed the design, or destructive acts), which may suddenly and unexpectedly release large volumes of water
- Failure of levees (associated with flows that exceed the design, weakening by seismic activity, lack of maintenance, or destructive acts), which may result in sudden flooding of areas behind levees

- Failure of seawalls, revetments, bulkheads, or similar coastal structures, which can lead to rapid erosion and increased flooding and wave damage during storms

Each type of flooding has characteristics that represent important aspects of the hazard. These characteristics should be considered in the selection of hospital sites, the design of new facilities, and the expansion or rehabilitation of existing flood-prone facilities.

Riverine flooding results from the accumulation of runoff from rainfall or snowmelt, such that the volume of water exceeds the capacity of waterway channels and spreads out over the adjacent land. Riverine flooding flows downstream under the force of gravity. Its depth, duration, and velocity are functions of many factors, including watershed size and slope, degree of upstream development, soil types and nature of vegetation, topography, and characteristics of storms (or depth of snowpack and rate of melting). Figure 3-1 illustrates a cross-section of a generic riverine floodplain.

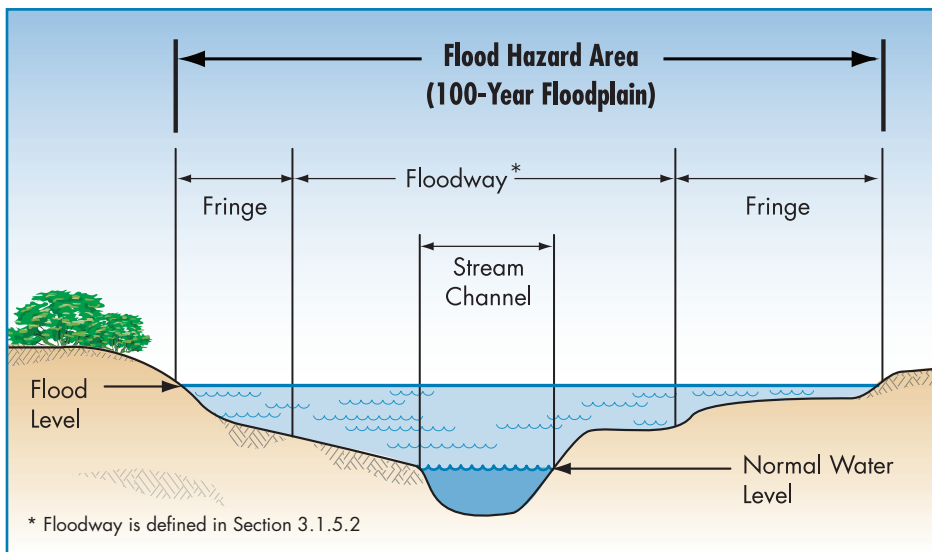

Figure 3-1:
The riverine floodplain

Coastal flooding is experienced along the Atlantic, Gulf, and Pacific coasts, and the Great Lakes. Coastal flooding is influenced by storm surges associated with tropical cyclonic weather systems (hurricanes, tropical storms, tropical depressions, typhoons), extratropical systems (nor'easters and other large low-pressure systems), seiches and tsunamis (surges induced by seismic activity). Coastal flooding is characterized by wind-driven waves which also may affect areas along the Great Lakes shorelines; winds blowing across the broad expanses of water generate waves that can rival those experienced along ocean shorelines. Some Great Lakes shorelines experience coastal erosion, in part because the erosion is associated with fluctuations in water levels. Figure 3-2 is a schematic of a generic coastal floodplain.

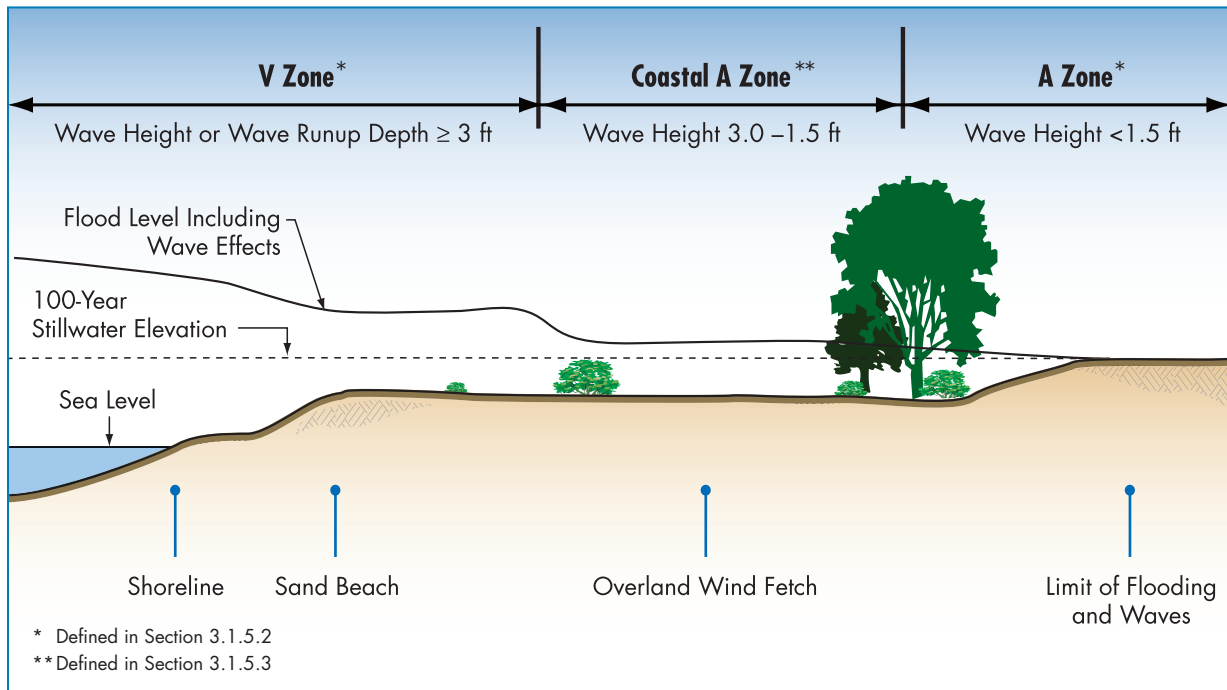

Figure 3-2: The floodplain along an open coast

3.1.2 PROBABILITY OF OCCURRENCE OR FREQUENCY

The probability of occurrence, or frequency, is a statement of the likelihood that an event of a certain magnitude will occur in a given period of time. For many decades, floodplain management has been based on the flood that has a 1 percent chance of occurring in any given year, commonly called the “100-year flood.” For certain critical actions and decisions, such as planning or constructing hospitals and emergency operations centers, the basis of risk decisions should be the flood that has a 0.2 percent probability of occurring in any given year, commonly called the “500-year flood.” In most locations, the benefits of added protection to the 500-year level are greater than the added costs.

The term “100-year flood” is often misunderstood because it conveys the impression that a flood of that magnitude will occur only once every 100 years. Actually, the 1-percent-annual-chance flood has one chance in 100 of occurring in any given year. The fact that a 1-percent-annual-chance flood is experienced at a specific location does not alter the probability that a flood of the same or greater magnitude could occur at the same location in the next year, or even multiple times in a single year. As the length of time considered increases, so does the probability that a flood of a specific magnitude or greater will occur. For example, Figure 3-3 illustrates the probability that a 100-year flood will occur is 26 percent in a

30-year period. And during a 70-year period (the potential useful life of many buildings), the probability increases to 50 percent. Similarly, a 500-year flood has a 0.2-percent probability of being equaled or exceeded in any given year, a 6 percent probability of occurrence in a 30-year period, and an 18 percent probability of occurrence during a 70-year period.

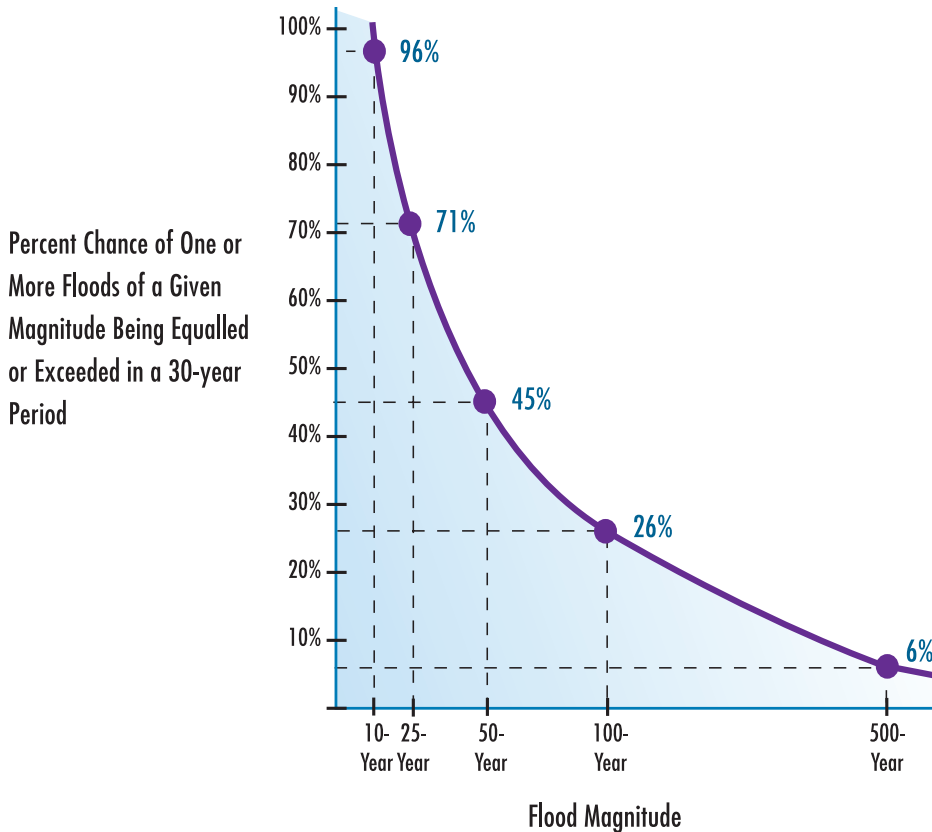

Figure 3-3:
Probability and magnitude

SOURCE: U.S. GEOLOGICAL SURVEY, GUIDELINES FOR DETERMINING FLOOD FLOW FREQUENCY, BULLETIN 17B (APPENDIX D).

The assigned frequency of a flood (e.g., 100-year) is independent of the number of years between actual occurrences. Hurricane Camille hit the Mississippi coast in 1969 with storm surge flooding that far exceeded previous events, and Hurricane Katrina affected much the same area. Although just 36 years apart, both storms produced flood levels that were significantly higher than the predicted 100-year flood. Similarly, the Mississippi River flooded large areas in Missouri in 1993 with flooding that exceeded the predicted 100-year flood levels. Just two years later, many of the same areas were flooded again.

Regardless of the flood selected for design purposes (the “design flood”), the designer must determine specific characteristics associated with that flood. Determining a flood with a specific probability of occurrence is done in a multi-step process that typically involves using computer models that are in the public domain. If a sufficiently long record of flood information exists, the design flood may be determined by applying statistical tools to the data. Alternatively, water resource engineers sometimes apply

computer models to simulate different rainfall events over watersheds, to predict how much water will run off and accumulate in channels. Other computer models are used to characterize the flow of water down the watershed and predict how high the floodwaters will rise.

Flood frequency analyses are performed using historical records, and the results are influenced by the length of the record. Such analyses do not account for recent changes to the land (upland development or subsidence) or future changes (additional development, greater subsidence, or climatic variations).

For coastal areas, both historical storms and simulated storm surge models can be used to predict the probability that floodwaters will rise to a certain level and be accompanied by waves of certain heights. Many coastal storms will produce storm surge flooding that, depending on local topography, may extend inland significantly farther than anticipated for a 1-percent-annual-chance flood. Statistically, such extreme storm surges occur less frequently than the 1-percent or 0.2-percent-annual-chance floods, but their consequences can be catastrophic.

The Saffir-Simpson Hurricane Scale categorizes hurricanes based on sustained wind speeds (see Chapter 4). Storm surge, though suggested by the Scale, is not always well correlated with the storm category because other factors influence surge elevations, notably forward speed of the storm, tide cycle, offshore bathymetry, and land topography.

Planners and designers should research the relationship between flood levels for different frequency events, including extreme events, especially in hurricane-prone communities. The difference in flood levels may be extreme in some situations, depending on local conditions and the source of flooding. In other areas flood levels of lower probability floods might not be much higher than a 1-percent-annual-chance flood.

The National Flood Insurance Program (NFIP) is a Federal program that encourages communities to regulate flood hazard areas and, in return, offers property owners insurance protection against losses from flooding (see Sections 3.1.6.1 and 3.1.6.2). The NFIP uses the 1-percent-annual-chance flood as the basis for flood hazard maps, for setting insurance rates, and for application of regulations in order to minimize future flood damage. The 1-percent-annual-chance flood is also used as the standard for examination of older buildings to determine the measures to apply in order to reduce future damage.

Satisfying the minimum requirements of the NFIP does not provide adequate protection for hospitals that need to be functional even after low-probability events. Nearly every year, a very low probability flood

occurs somewhere in the United States, often with catastrophic consequences. Therefore, for planning and design of hospitals, use of a lower probability flood (at least the 500-year) is strongly recommended (and may be required by some States and local jurisdictions). As noted in Section 3.1.6.3, the 500-year level of protection is required if Federal funds are involved in constructing facilities that are vital for emergency response and rapid recovery, including hospitals, emergency operations centers, emergency shelters, and other buildings that support vital services. This reinforces the importance of protecting both the functionality and financial investment in a hospital with stricter standards than those applied to other buildings.

3.1.3 FLOOD CHARACTERISTICS AND LOADS

A number of factors associated with riverine and coastal flooding are important in the selection of sites for hospitals, in site design, and in the determination of flood loads which must be considered as part of architectural and engineering design.

Depth: The most apparent characteristic of any flood is the depth of the water. Depending on many factors, such as the shape of a river valley or the presence of obstructing bridges, riverine flooding may rise just a few feet or tens of feet above normal levels. The depth of coastal flooding is influenced by such factors as the tidal cycle, the duration of the storm, the elevation of the land, offshore bathymetry, and the presence of waves. Depth is a critical factor in building design because the hydrostatic forces on a vertical surface (such as a foundation wall) are directly related to depth, and because costs associated with protecting buildings from flooding increase with depth. Under certain conditions, hurricanes can produce storm surge flooding that is 20 to 30 feet above mean sea level or, in extreme cases along the Gulf Coast, as much as 35 feet above mean sea level.

Duration: Duration is the measure of how long the water remains above normal levels. The duration of riverine flooding is primarily a function of watershed size and the longitudinal slope of the valley (which influences how fast water drains away). Small watersheds are more likely to be “flashy,” a characteristic that refers to the rapidity with which floodwaters rise and fall. Areas adjacent to large rivers may be flooded for weeks or months. Most coastal flooding is influenced by the normal tidal cycle, as well as how fast coastal storms move through the region. Areas subject to coastal flooding can experience long periods of flooding where drainage is poor or slow as a result of topography or the presence of flood control structures. For example, water may be trapped in depressions in the land or behind a floodwall or levee with inadequate drainage. More

commonly, coastal flooding is of shorter duration, on the order of 12 to 24 hours, especially if storms move rapidly. Flooding of large lakes, including those behind dams, can be of very long duration because the large volume of water takes longer to drain. For building design, duration is important because it affects access, building usability, and saturation and stability of soils and building materials. Information about flood duration is sometimes available as part of a flood study, or could be developed by a qualified engineer.

Local drainage problems create ponding and local flooding that is often not directly associated with a body of water such as a creek or river. Although such flooding is relatively shallow and not characterized by high velocity flows, considerable damage may result. Areas with poor drainage frequently experience repetitive damage. Some local drainage problems are exacerbated by old or undersized drainage system infrastructure. Flooding caused by drainage problems typically occurs as sheetflow or along waterways with small drainage areas. This type of flooding is often not mapped or regulated.

Velocity: The velocity of floodwaters ranges from extremely high (associated with flash floods or storm surge) to very low or nearly stagnant (in backwater areas and expansive floodplains). Velocity is important in site planning because of the potential for erosion. In structural design, velocity is a factor in determining the hydrodynamic loads and impact loads. Even shallow, high-velocity water can threaten the lives of pedestrians and motorists. Accurate estimates of velocities are difficult to make, although information about mean velocities may be found in some floodplain studies.

Wave action: Waves contribute to erosion and scour, and also contribute significantly to design loads on buildings. The magnitude of wave forces can be 10 to more than 100 times greater than wind and other design loads, and thus may control many design parameters. Waves must be accounted for in site planning along coastal shorelines, in flood hazard areas that are inland of open coasts, and other areas where waves occur, including areas with sufficient fetch that winds can generate waves (such as lakes and expansive riverine floodplains). Waves on top of storm surges may be as much as 50 percent higher than the stillwater depth of the surge.

Impacts from debris and ice: Floating debris and ice contribute to the loads that must be accounted for in structural design. The methods and models used to predict and delineate flood hazard areas do not specifically incorporate the effects of debris. Thus, there are few sources to determine the potential effects of debris impact loads, other than past observations and judgment.

Erosion and scour: In coastal areas, erosion refers to the lowering of the ground surface as a result of a flood event, or the gradual recession of a shoreline as a result of long-term coastal processes. Along riverine waterways, erosion refers to undermining of channel banks, lateral movement of the channel, or cutting of new channels. Scour refers to a localized lowering of the ground surface due to the interaction of currents and/or waves with structural elements, such as pilings. Soil characteristics influence an area's susceptibility to scour. Erosion and scour may affect the stability of foundations and earthen-filled areas, and may cause extensive site damage.

3.1.3.1 Hydrostatic Loads

Hydrostatic loads occur when water comes into contact with a building or building component, both above and below the ground level. They act as lateral pressure or vertical pressure (buoyancy). Hydrostatic loads on inclined or irregular surfaces may be resolved into lateral and vertical loads based on the surface geometry and the distribution of hydrostatic pressure.

Lateral hydrostatic loads are a direct function of water depth (see Figure 3-4). These loads can cause severe deflection or displacement of buildings or building components if there is a substantial difference in water levels on opposite sides of the component (or inside and outside of the building). Hydrostatic loads are balanced on foundation elements of elevated buildings, such as piers and columns, because the element is surrounded by water. If not oriented parallel to the flow of water, shearwalls may experience hydrostatic loads due to a difference of water depth on either side of the wall. To reduce excessive pressure from standing water, floodplain management requirements in A Zones call for openings in walls that enclose areas below the flood elevation (see description of continuous perimeter wall foundation in Section 3.4.4).

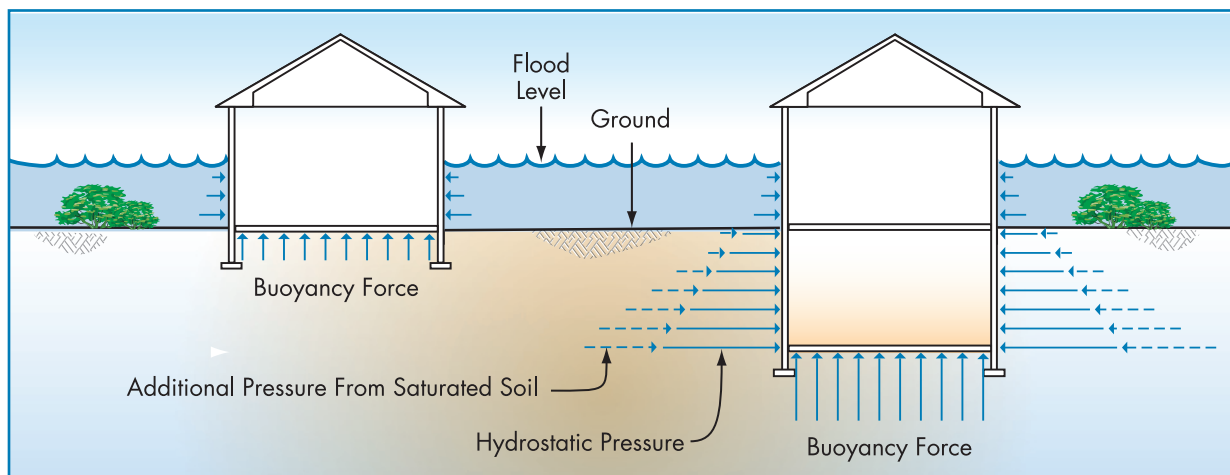

Figure 3-4: Hydrostatic loads on buildings

Buoyancy force resulting from the displacement of water is also of concern, especially for dry floodproofed buildings and aboveground and underground tanks. Buoyancy force is resisted by the dead load of the building or the weight of the tank. When determining buoyancy force, the weight of occupants or other live loads (such as the contents of a tank) should not be considered. If the building or tank does not weigh enough “empty,” then additional stabilizing measures need to be taken to avoid flotation. This becomes a significant consideration for designs intended to dry floodproof a building. Buoyancy force is slightly larger in saltwater, because saltwater weighs slightly more than fresh water.

3.1.3.2 Hydrodynamic Loads

Water flowing around a building or a structural element that extends below the flood level imposes hydrodynamic loads. The loads, which are a function of flow velocity and structure geometry, include frontal impact on the upstream face, drag along the sides, and suction on the downstream side (see Figure 3-5). Ways to determine or estimate flood velocities are described in Section 3.1.4.3 and Section 3.1.4.4.

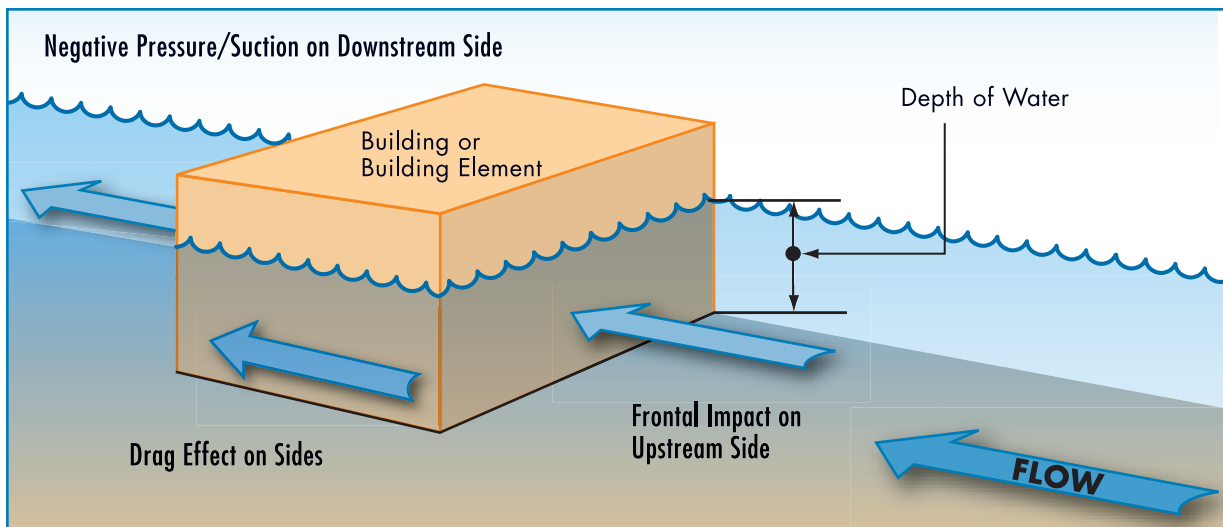

Figure 3-5: Hydrodynamic loads on a building or building element

The most common computation methods for hydrodynamic loads are outlined in the design standard ASCE 7, *Minimum Design Loads for Buildings and Other Structures*, produced by the American Society of Civil Engineers’ Structural Engineers Institute (ASCE/SEI, 2005). Those methods assume that the flood velocity is constant (i.e., steady state flow) and that the dynamic load imposed by floodwaters moving at less than 10 feet per second can be converted to an equivalent hydrostatic load. This conversion is accomplished by adding an equivalent surcharge depth to

the depth of water on the upstream side. The equivalent surcharge depth is a function of the velocity. Loads imposed by floodwaters with velocities greater than 10 feet per second cannot be converted to equivalent hydrostatic loads. Instead, they must be determined according to the principles of fluid mechanics or hydraulic models.

Hydrodynamic loads become important when flow reaches moderate velocities of 5 feet per second. The components of hydrodynamic loads are laterally imposed, caused by the impact of the mass of water against the building, and drag forces along the wetted surfaces. Drag coefficients for common building elements, such as columns and piers, can be found in a number of sources. ASCE 7 recommends values for a variety of conditions.

Wave loads are another important component of hydrodynamic loads. As described in ASCE 7, “design and construction of buildings and other structures subject to wave loads shall account for the following loads: waves breaking on any portion of the building or structure; uplift forces caused by shoaling waves beneath a building or structure, or portion thereof; wave runup striking any portion of the building or structure; wave-induced drag and inertia forces; and wave-induced scour at the base of a building or structure, or its foundation.”

Wave forces striking buildings and building elements can range from 10 to more than 100 times wind or other forces. Forces of this magnitude can be substantial, even when acting over the relatively small surface area of the supporting structure of elevated buildings. Post-storm damage inspections show that breaking wave loads overwhelm virtually all wood-frame and unreinforced masonry walls below the wave crest elevation. Only engineered or massive structural elements are capable of consistently withstanding breaking wave loads.

The magnitude of wave forces is the rationale behind the floodplain management requirement for the bottom of the lowest horizontal structural member to be at or above the design flood elevation in environments where high-velocity wave action from storms or seismic sources is possible (called V Zones, also referred to as Coastal High Hazard Areas). In V Zones, breaking wave heights or wave runup depths are predicted to be 3 feet or higher. Because breaking waves as small as 1.5 feet in height can impose considerable loads, there is a growing awareness of the value of accounting for waves in areas immediately landward of V Zones, which are referred to as “Coastal A Zones” (see Section 3.1.5.3).

Of the variety of wave forces described in ASCE 7—breaking waves, uplift, wave runup, wave-induced drag and inertia, and scour—breaking waves constitute the greatest hazard. Designers should therefore use breaking

wave forces as the basis of the design load. Computation of breaking wave loads depends on the determination of wave height. For further information on how wave heights can be estimated, see Section 3.1.4.1. Designers should refer to ASCE 7 for detailed discussion and computation procedures for determining breaking wave loads.

Breaking wave loads on vertical walls or supporting structural members reach a maximum when the direction of wave approach is perpendicular to the wall. It is common to assume that the direction of approach will be perpendicular to the shoreline, in which case the orientation of the wall to the shoreline will influence the direction of approach used in load calculations. ASCE 7 provides a method for reducing breaking wave loads on vertical walls for waves that approach a building from a direction other than straight on.

Breaking wave forces are much higher than typical wind pressures, even wind pressures that occur during a hurricane or typhoon. However, the duration of individual loads is brief, with peak pressures probably occurring within 0.1 to 0.3 seconds after the wave breaks. Structures are to be designed for repetitive impact loads that occur over the duration of a storm. Some storms may last just a few hours, as hurricanes move through the area, or several days, as during some winter coastal storms (nor'easters) that affect the Mid-Atlantic and northeastern States.

3.1.3.3 Debris Impact Loads

Debris impact loads on a building or building element are caused by objects carried by moving water. Objects commonly carried by floodwaters include trees, dislodged tanks, and remnants of manmade structures such as docks and buildings. Extreme impact loads result from less common sources, such as shipping containers, boats, and barges. The magnitude of these loads is very difficult to predict, yet some reasonable allowance should be made during the design process.

Impact loads are influenced by the location of the building in the potential debris stream. The potential for debris impacts is significant if a building is located immediately adjacent to, or downstream from, other buildings, among closely spaced buildings, or downstream from large floatable objects. While these conditions may be observable in coastal areas, it is more difficult to estimate the potential for debris in riverine flood hazard areas. Any riverine waterway, whether a large river or smaller urban stream, can carry large quantities of debris, especially uprooted trees and trash.

The basic equation for estimating the magnitude of impact loads depends on several variables that must be selected by the designer. These variables

include several coefficients, building or building element stiffness, debris weight, debris velocity, and duration of impact. The latter three variables, described in more detail in ASCE 7, are briefly described below.

Debris weight: Debris weight is one of the more difficult variables to estimate. Unless otherwise indicated by field conditions, ASCE 7 recommends using an average object weight of 1,000 pounds. This weight corresponds to a 30-foot long log that is 1 foot in diameter, which is relatively small compared to large trees that may be uprooted during a flood. In coastal areas, expected debris weights depend on the nature of the debris. In the Pacific Northwest, large trees and logs are common, with weights in excess of 4,000 pounds. In areas where piers and pilings are likely to become debris, 1,000 pounds is reasonable. In areas where most debris is likely to result from building damage (failed decks, steps, failed walls, propane tanks), the average debris weight may be less than 500 pounds.

Debris velocity: The velocity of the debris when it strikes a building depends on the nature of the debris and the velocity of floodwaters. For the impact load computation, the velocity of the water-borne object is assumed to be the same as the flood velocity. Although this assumption is reasonable for smaller objects, it is considered conservative for large objects.

Debris impact duration: Duration of impact is the elapsed time during which the impact load acts on the building or building element. The duration of impact is influenced primarily by the natural frequency¹ of the building or element, which is a function of the building's stiffness. Stiffness is determined by the properties of the material, the number of supporting members (columns or piles), the height of the building above the ground, and the height at which the element is struck. Despite all the variables that may influence duration of impact, early assumptions suggested 1-second duration. A review of results from several laboratory tests that measured impacts yielded much briefer periods, and ASCE 7 currently recommends the duration of 0.03 second.

3.1.3.4 Erosion and Local Scour

Strictly speaking, erosion and scour are not loads; however, they must be considered during site evaluation and load calculations because they increase the local flood depth, which in turn influences load calculations.

¹ Natural frequency is the frequency at which an object will vibrate freely when set in motion.

Erosion may occur in riverine and coastal flood hazard areas. In coastal areas, storms can erode or completely remove sand dunes, which act as barriers to flooding and damaging waves. Erosion may also lower the ground surface or cause a short-term or long-term recession of the shoreline. In areas subject to gradual erosion of the ground surface, additional foundation embedment depth can mitigate the effects. However, where waterways are prone to changing channels and where shoreline erosion is significant, engineered solutions are unlikely to be effective. Avoidance of sites in areas subject to active erosion usually is the safest and most cost-effective course of action.

Local scour results from turbulence at the ground level around foundation elements. Scour occurs in both riverine and coastal flood hazard areas, especially in areas with erodible soils. Determining potential scour is critical in the design of foundations, to ensure that the bearing capacity or anchoring resistance of the soil around posts, piles, piers, columns, footings, or walls is not compromised. Scour determinations require knowledge of the flood depth, velocity, waves, soil characteristics, and foundation type.

At some locations, soil at or below the ground surface can be resistant to local scour, and calculated scour depths based on unconsolidated surface soils below will be excessive. In instances where the designer believes the underlying soil at a site will be scour-resistant, the assistance of a geotechnical engineer or geologist should be sought to verify that assumption.

3.1.4 DESIGN PARAMETERS

Flood hazards and characteristics of flooding must be identified to evaluate the impact of site development and to determine the design parameters necessary to calculate flood loads, to design floodproofing measures, and to identify and prioritize retrofit measures for existing hospitals. Table 3-3 in Section 3.6 outlines a series of questions to facilitate this objective.

3.1.4.1 Flood Depth

Flood depth is the most important factor required to compute flood loads because almost every other flood load calculation depends directly or indirectly on this factor. The first step in determining flood depth at a specific site is to identify the flood that is specified by governing authorities' regulations. The most common flood used for design is the "base flood" (see Section 3.1.4.2). The second step is to determine the expected elevation

of the ground at the site. This expected ground elevation must account for any erosion, scour, subsidence, or other ground eroding condition that occurs over time. Flood depth is computed by subtracting the ground elevation from the flood elevation. Since these data usually are obtained from different sources, it is important to determine whether they are based on the same datum. If not, standard corrections must be applied.

In riverine areas, the flood elevations shown on flood hazard maps rarely account for waves. Fast moving water usually has an undulating surface that is referred to as “standing waves,” which do not break as do waves in coastal areas. Standing waves may rise higher than the flood elevation specified on maps used for regulatory purposes, thus increasing flood depth. This increase should be taken into account when determining flood loads by increasing the flood depth used for design purposes.

In coastal areas, the flood elevations shown on FEMA flood maps account for stillwater flooding plus local wave effects, including wave heights, wave runup, or wave overtopping over vertical walls. As shown in Figure 3-6, subtracting the ground elevation from the FEMA flood map elevation will provide a flood depth comprised of the stillwater component and the predicted wave contribution.

For design purposes, it is important to know that wave forces on buildings cause the most damage. FEMA has identified V Zones (velocity zones) on coastal flood maps, where wave heights or wave runup depths are predicted to be 3 feet or greater (see Section 3.1.5.2). However, post-disaster assessments and laboratory studies have shown that waves as small as 1.5 feet in height can also cause significant damage. While FEMA flood maps do not specifically designate flood hazard areas subject to 1.5- to 3-foot waves, referred to as “Coastal A Zones” (see Section 3.1.5.3). It is important to consider these smaller waves and their potential damaging effects on buildings.

Figure 3-6 illustrates the two main principles that are used to estimate wave heights at a particular site. Equations for wave height are based on the concept that waves are depth-limited, that is, waves propagating into shallow water will break when the wave height reaches a certain proportion of the underlying stillwater depth. For modeling wave heights during the base flood, FEMA utilizes the proportion determined by the National Academy of Sciences (1977): the total wave height will reach a maximum of 78 percent of stillwater depth before breaking. At any given site, this proportion may be reduced because of obstructions between open water and the site, such as dense stands of vegetation or unelevated buildings. In V Zones, 3-foot waves can be supported in only 4 feet of stillwater and the smaller “Coastal A Zone” waves of 1.5 feet can be supported in only 2 feet of stillwater. The second principle is that the wave

height extends from the trough, which is below the stillwater elevation to the crest, which is above the stillwater elevation, and is equal to 55 percent of this stillwater depth.

Figure 3-6:
Definition sketch
– coastal wave height
and stillwater depth

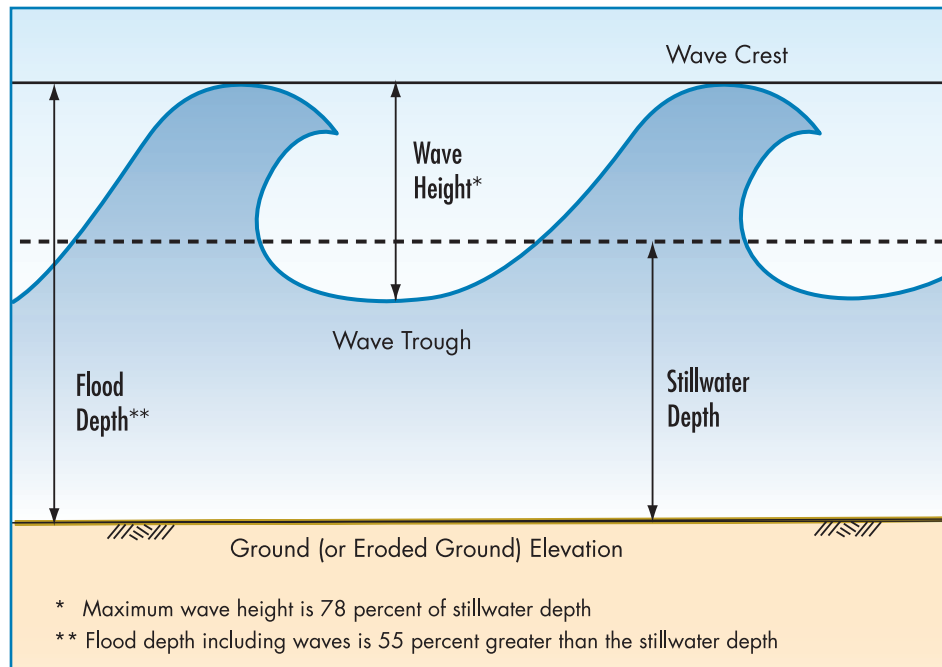

Using these two principles, some general rules of thumb are available to estimate wave heights. If the only information available is the base flood depth (i.e., the depth calculated using the FEMA flood map elevation minus the ground elevation), assume that flood depths between 3 and 6 feet can have an added wave-height component between 1.5 and 3 feet, while flood depths of 6 feet or more will likely have wave heights in excess of 3 feet. If only the stillwater flood depth is known (from an alternative surge map or other data source), the maximum flood depth (including wave height) will be approximately 1.5 times the stillwater depth.

In any area with erodible soils, whether coastal or inland site, designers need to consider the effects of erosion where floodwaters lower the

ground surface or cause local scour around foundation elements. The flood depth determined using flood elevation and ground elevation should be increased to account for changes in conditions during a flood event. Not only does lowering the ground surface effectively result in deeper water against the foundation, it may also remove supporting soil from the foundation, which must be accounted for in the foundation design.

Waves and storm-induced erosion are most common in coastal areas. However, wide rivers and lakes may experience wind-driven waves and erodible soils are found throughout the United States. For more information about waves and erosion, refer to FEMA 55, *Coastal Construction Manual*.

3.1.4.2 Design Flood Elevation

The design flood elevation (DFE) establishes the minimum level of flood protection that must be provided. The DFE, as used in the model building codes, is defined as either the base flood elevation (BFE) determined by the NFIP and shown on FIRMs, or the elevation of a design flood designated by the community, whichever is higher. The DFE will always be at least as high as the BFE. Communities may use a design flood that is higher than the base flood for a number of reasons. For example, a design flood may be used to account for future upland development, to recognize a historic flood, or to incorporate a factor of safety, known as freeboard.

“Freeboard” is a factor of safety usually expressed in feet above a flood level. Freeboard compensates for the many unknown factors that could contribute to flood heights, such as wave action, constricting bridge openings, and the hydrological effect of urbanization of the watershed. A freeboard of 1 to 3 feet is often applied to hospitals.

Facility owners, planners, and designers should check with the appropriate regulatory authority to determine the minimum flood elevation to be used in site planning and building design. Although the NFIP minimum is the BFE, State or local regulations commonly cite the 0.2-percent-annual-chance flood (500-year flood) as the design requirement for hospitals, or the regulations may call for added freeboard above the minimum flood elevation. Even if there is no specific requirement to use the 0.2-percent-annual-chance flood for siting and design purposes, it is strongly recommended that decisionmakers take into consideration the flood conditions associated with this lower probability event.

If significant flood events have occurred since the effective date of the FIRM, these events may change the statistical analyses, which might prompt an update of the flood maps and produce revised elevations for the 1-percent-annual-chance flood. Hospital owners, planners, and designers should contact community officials to determine whether there have been any significant flood events or other changes that may affect flood hazards since the effective date of the FIRM. The best available information should be used at all times.

After Hurricane Katrina in 2005, FEMA expedited development of Flood Recovery Maps and Advisory Base Flood Elevations for the Mississippi coast; the new maps were delivered less than 3 months after the storm.

In 2004, after widespread wildfires in California changed runoff characteristics, FEMA developed recovery maps to show increased riverine flood hazards.

3.1.4.3 Flood Velocity—Riverine

There are few sources of information that are readily available for estimating flood velocities at specific locations along riverine bodies of water.

If a riverine source has been studied using detailed hydraulic methods, some information may be available in summary form in published studies. Studies prepared for the NFIP contain tables of data for waterways for which floodways were delineated (see Section 3.1.5.2). For specified cross-sections along the waterway, the Floodway Data Table includes a mean velocity expressed in feet per second. This value is the average of all velocities across the floodway. Generally, velocities in the flood fringe (landward of the floodway) will be lower than in the floodway.

For waterways without detailed studies, methods that are commonly used in civil engineering for estimating open channel flow velocities can be applied.

3.1.4.4 Flood Velocity—Coastal

Estimating flood velocities in coastal flood hazard areas involves considerable uncertainty and there is little reliable historical information or measurements from actual coastal flood events. In this context, velocity does not refer to the motion associated with breaking waves, but the speed of the mass movement of floodwater over an area.

The direction and velocity of floodwaters can vary significantly throughout a coastal flood event. Floodwaters can approach a site from one direction as a storm approaches, then shift to another direction (or through several directions) as the storm moves through the area. Floodwaters can inundate some low-lying coastal sites from both the front (e.g., ocean) and the back (e.g., bay, sound, or river). In a similar manner, at any given site, flow velocities can vary from close to zero to very high. For these reasons, when determining flood loads for building design, velocities should be estimated conservatively, and it should be assumed that floodwaters can approach from the most critical direction.

Despite the uncertainties, there are methods to approximate coastal flood velocities. One common method is based on the stillwater depth (flood depth without waves). Designers should consider the topography, the distance from the source of flooding, and the

Upper bound velocities caused by Hurricane Katrina along the Mississippi coast, where storm surge depths neared 25 feet deep (with waves, total flood depths approached 35 feet), have been estimated at nearly 30 feet per second (20 miles per hour).

proximity to other buildings and obstructions before selecting the flood velocity for design. Those factors can direct and confine floodwaters, with a resulting acceleration of velocities. This increase in velocities is described as the “expected upper bound.” The “expected lower bound” velocities are experienced in areas where those factors are not expected to influence the direction and velocity of floodwaters.

Figure 3-7 shows the general relationship between velocity and stillwater depth. For design purposes, actual flood velocities are assumed to lie between the upper and lower bounds. Conservative designs will use the upper bound velocities.

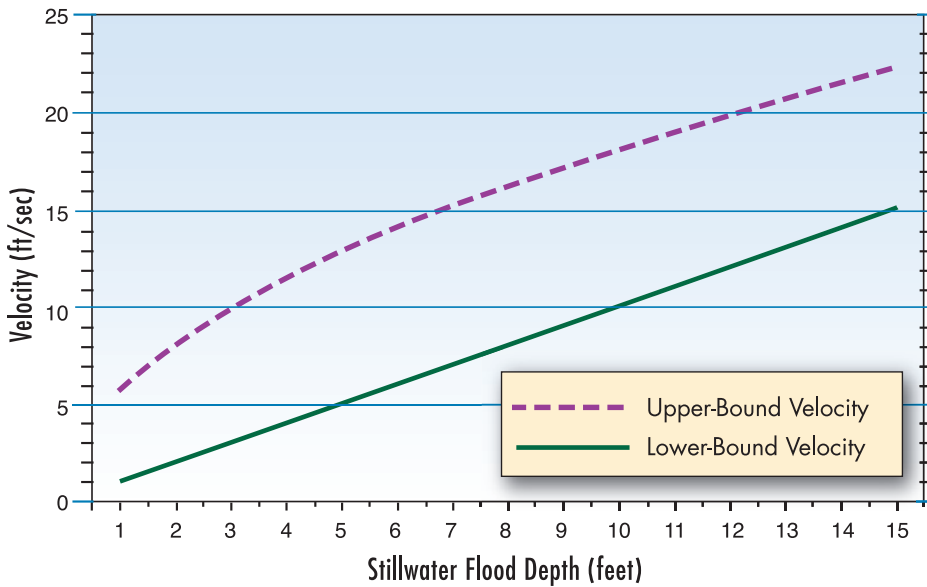

Figure 3-7:
Velocity as a function
of stillwater flood
depth

3.1.5 FLOOD HAZARD MAPS AND ZONES

Flood hazard maps identify areas of the landscape that are subject to flooding, usually flooding by the 1-percent-annual-chance flood. Maps prepared by the NFIP are the minimum basis of State and local floodplain regulatory programs. Some States and communities have prepared maps of a floodplain based on the assumption that the upper watershed area is fully developed according to existing zoning. Some communities base their regulations on a flood of record or a historically significant flood that exceeds the base flood shown on the NFIP maps.

The flood hazard maps used by the appropriate regulatory authority should be consulted during planning and site selection, site design, and architectural and engineering design (whether for the design of new buildings or rehabilitation of existing buildings). Regardless of the flood hazard data required for regulatory purposes, additional research should be conducted on past major floods and other factors that could lead to more severe flooding.

3.1.5.1 NFIP Flood Maps

The NFIP produces Flood Insurance Rate Maps (FIRMs) for more than 20,000 communities nationwide. FIRMs are prepared for each local jurisdiction that has been determined to have some degree of flood risk. The current effective maps are typically available for viewing in community planning or permit offices.² It is important to use the most recent flood hazard map when determining site-specific flood hazard characteristics. Although many FIRMs are more than 15 years old, often one or more panels or portions of a map panel have been revised and republished. Communities must adopt revised maps to continue participating in the NFIP.

Some FIRMs do not show the 0.2-percent-annual-chance flood hazard area (500-year floodplain), and many FIRMs do not provide detailed information about predicted flood elevations along every body of water, especially smaller streams and tributaries. Determining the 500-year flood is especially difficult when records of past flood events are limited. When existing data are insufficient, additional statistical methods and engineering analyses are necessary to determine the flood-prone areas and the appropriate characteristics of flooding required for site layout and building design. If a proposed hospital site or existing hospital is affected by flooding, a site-specific topographic survey is critical to delineate the land that is below the flood elevation used for planning purposes. If detailed flood elevation information is not available, a floodplain study may be required to identify the important flood characteristics and data required for sound design. However, having flood hazard areas delineated

It is important to note that the number of revised and updated FIRMs is increasing rapidly. During the last few years FEMA, in partnership with many States and communities, has been implementing an initiative to modernize and update all maps that are determined to be out of date. The modernization process may involve an examination of flood experience in the period since the original flood studies were prepared, use of more detailed topographic and base maps, re-computation of flood discharges and flood heights, and re-delineation of flood hazard area boundaries.

on a map conveys a degree of precision that may be misleading. Flood maps have a number of limitations that should be taken into consideration, especially during site selection and building design. Some of the well-known limitations are:

- Flood hazard areas are approximations based on probabilities; the flood elevations shown and the areas delineated should not be taken as absolutes, in part because they are based on numerical approximations of the real world.

² Flood maps may also be viewed at FEMA's Map Service Center at <http://msc.fema.gov>. For a fee, copies may be ordered online or by calling (800) 358-9616. The Flood Insurance Study (FIS) and engineering analyses used to determine the flood hazard area may be ordered through the FEMA Web site.

- For the most part, floodplains along smaller streams and drainage areas (less than 1 square mile) are not shown.
- Especially for older maps, the topography used to delineate the flood boundary may have had contour intervals of 5, 10, or even 20 feet, which significantly affects the precision with which the boundary is determined. The actual elevation of the ground relative to the flood elevation is critical, as opposed to whether an area is shown as being in or out of the mapped flood hazard area.
- Maps are based on the data available at the time they were prepared, and, therefore, do not account for subsequent upland development that increases rainfall-runoff, which may increase flooding.
- The scale of the maps may impede precise determinations (many older maps are 1 inch = 2,000 feet).
- The land surface of the floodplain may have been altered by modifications after the maps were prepared, including fills, excavations, or levees.
- Local conditions are not reflected, especially conditions that change regularly, such as stream bank erosion and shoreline erosion.
- Areas exposed to very low probability flooding are not shown, such as flooding from extreme hurricane storm surges, extreme riverine flooding, dam failures, or overtopping or failure of levees.

In communities along the Gulf and Atlantic coasts, facility owners, planners, and designers should check with emergency management offices for maps that estimate storm surge flooding from hurricanes. Local planning or engineering offices may have post-disaster advisory flood maps and documentation of past storm surge events. The FIRMs and regulatory design flood elevations (DFEs) do not reflect low probability/high magnitude flooding that may result from a hurricane making landfall at a specific location.

Be aware that most storm surge maps report stillwater flood elevations only; local wave heights or wave runup are seldom included. If necessary, local wave effects should be estimated and added to the stillwater elevation when determining flood depths for design purposes (see Section 3.1.4.1).

3.1.5.2 NFIP Flood Zones

The flood hazard maps prepared by the NFIP show different flood zones to delineate different floodplain characteristics (see Figures 3-8, 3-9, and

3-10). The flood zones shown on the NFIP maps, and some other designations, are described below.

A Zones: Also called “unnumbered A Zones” or “approximate A Zones,” this designation is used for flood hazard areas where engineering studies have not been performed to develop detailed flood elevations. BFEs are not provided. Additional engineering analyses and site-specific assessments usually are required to determine the DFE.

“Base flood elevation” (BFE) is the elevation above a datum to which floodwaters are predicted to rise during the 1-percent-annual-chance flood (also called the “base flood” or the 100-year flood).

AE Zones or A1-A30 Zones: Also called “numbered A Zones,” these designations are used for flood hazard areas where engineering analyses have produced detailed flood elevations and boundaries for the base flood (1-percent-annual-chance flood). BFEs are provided. For riverine waterways with these zones, FISs include longitudinal profiles showing water surface elevations for different frequency flood events.

For riverine waterways with these zones, FISs include longitudinal profiles showing water surface elevations for different frequency flood events.

Floodways: The floodway includes the waterway channel and adjacent land areas that must be reserved in order to convey the discharge of the base flood without cumulatively increasing the water surface elevation above a designated height. Floodways are designated for most waterways that have AE Zones or numbered A Zones. FISs include data on floodway widths and mean floodway velocities.

AO and AH Zones: These zones include areas of shallow flooding and are generally shown where the flood depth averages from 1 to 3 feet, where a clearly defined channel does not exist, where the path of flooding is unpredictable, and where velocity flow may be evident. These zones are characterized by ponding or sheetflow. BFEs may be provided for AH Zones; flood depths may be specified in AO Zones.

Shaded X (or B) Zones: This zone shows areas of the 500-year flood (0.2-percent-annual-chance flood), or areas protected by flood control levees. This zone is not shown on many NFIP maps, and its absence does not imply that flooding of this frequency will not occur.

Unshaded X (or C) Zones: These zones are all land areas not mapped as flood hazard areas that are outside of the floodplain that is designated for the purposes of regulating development pursuant to the NFIP. These zones may still be subject to small stream flooding and flooding from local drainage problems.

V Zones (V, VE, and V1-V30): Also known as Coastal High Hazard Areas or special flood hazard areas subject to high-velocity wave action. V Zones

are relatively narrow areas along open coastlines and some large lake shores that are subject to high-velocity wave action from storms or seismic sources. V Zones extend from offshore to the inland limit of a primary frontal dune, or to an inland limit where the predicted breaking wave height or wave runup depth drops below 3 feet.

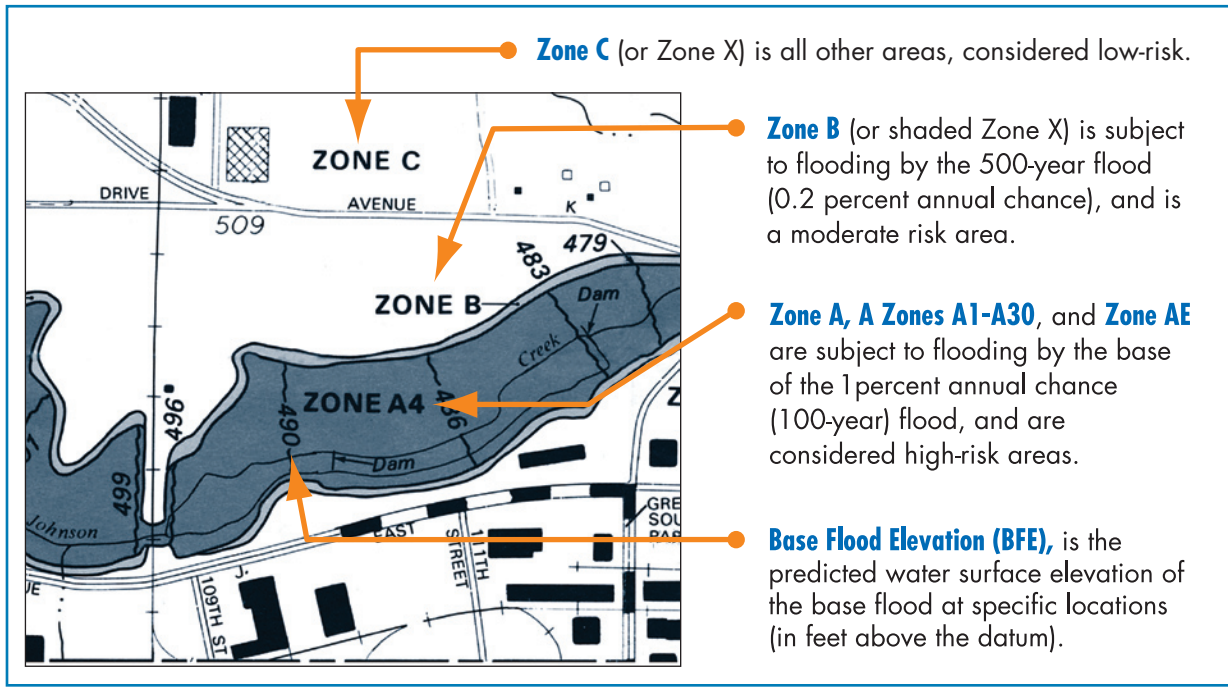

Figure 3-8: Riverine flood hazard zones

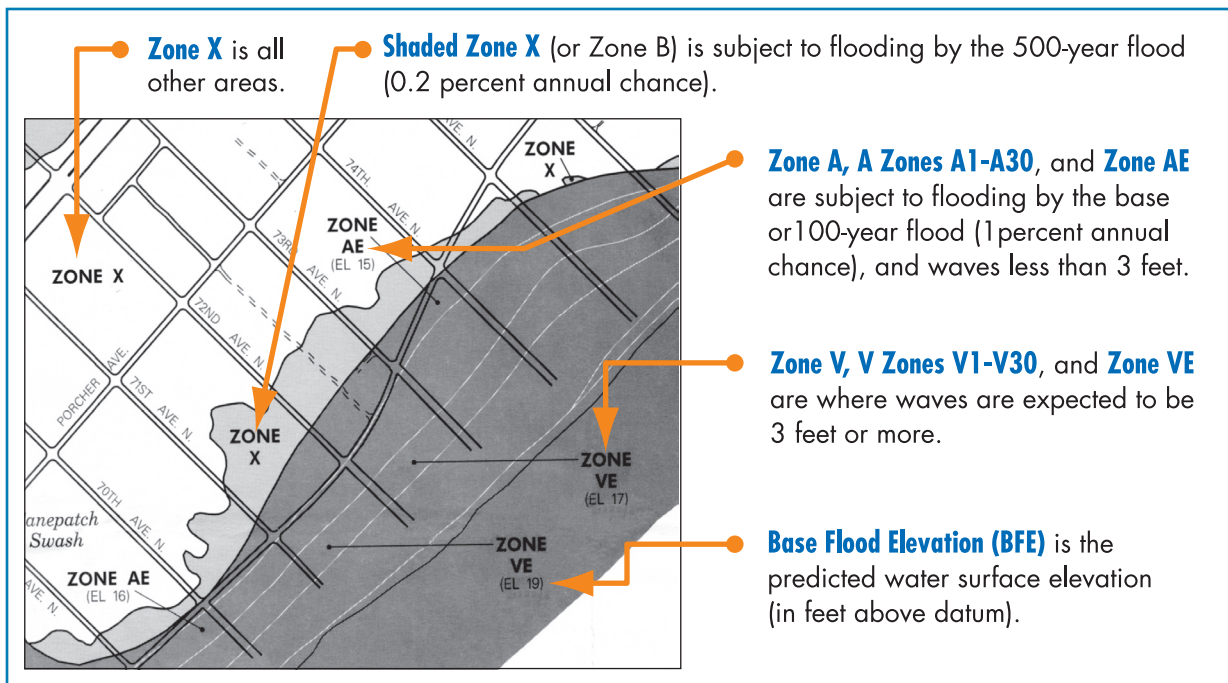

Figure 3-9: Coastal flood hazard zones

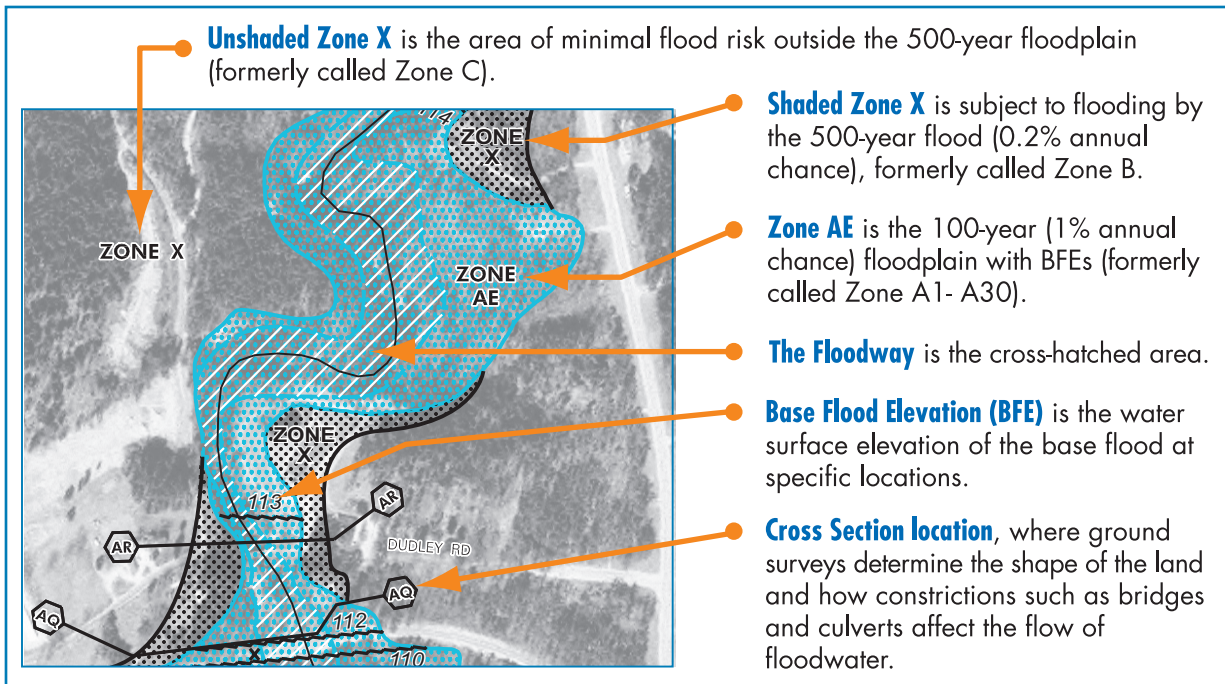

Figure 3-10: Sample digital FIRM format used for modernized maps

3.1.5.3 Coastal A Zones

As shown in Figure 3-9, coastal floodplains can be subdivided into A Zones and, where Primary Frontal Dunes occur or wave heights or runup depths exceed 3 feet, V Zones. NFIP maps do not currently differentiate which portions of the A Zone will experience wave heights between 1.5 and 3 feet, which are capable of causing structural damage to buildings. These areas of special concern, called Coastal A Zones, can be identified through assessment of coastal flood hazard data (see Figure 3-11).

Coastal A Zones are present where two conditions exist: where the expected stillwater flood depth is sufficient to support breaking waves 1.5 to 3 feet high, and where such waves can actually occur. The first condition occurs where stillwater depths (vertical distance between the stillwater elevation and the ground) are more than 2 feet deep. The second condition occurs where there are few obstructions between the shoreline and the site. In these areas, the principal sources of flooding are tides, storm surges, seiches, or tsunamis, not riverine flooding.

The current editions of the model building codes refer to ASCE 7 and ASCE 24; both design standards include requirements for Coastal A Zones.

The stillwater depth requirement is necessary, but is not sufficient by itself to warrant designation as a Coastal A Zone. This is because obstructions in the area may

block wind (limiting the initial growth of waves) or cause friction that attenuates wave energy. Obstructions can include buildings, locally high ground, and dense, continuous stands of vegetation (trees, shrubs, etc.). Designers should determine whether Coastal A Zone conditions are likely to occur at a hospital site because of the anticipated wave action and loads. This determination is based on an examination of the site and its surroundings, the actual surveyed ground elevations, and the estimated wave heights (calculated using predicted stillwater elevations found in the FIS or derived from elevations shown on the FEMA flood map; see Section 3.1.4.1).

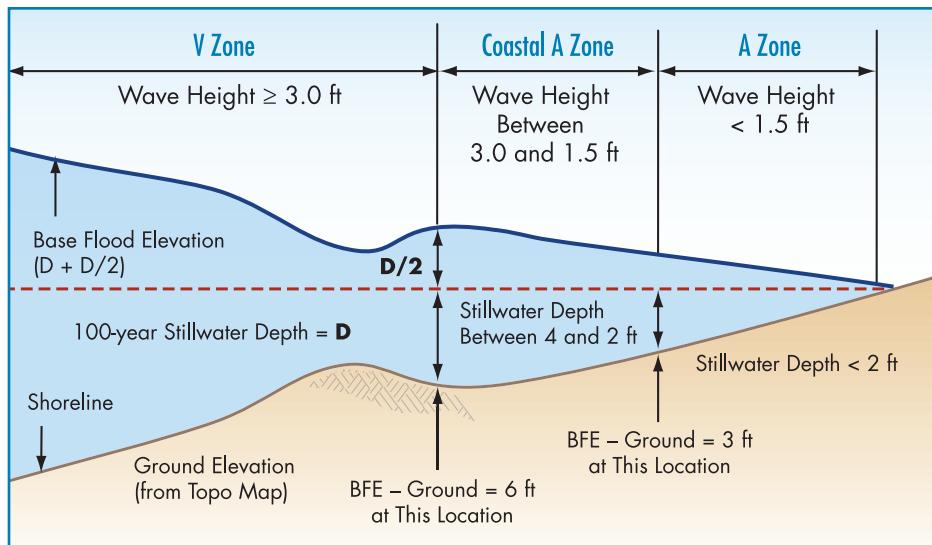

Figure 3-11: Flood hazard zones in coastal areas

When a decision is made to build a hospital in a Coastal A Zone, the characteristics of the site and the nature of the flood hazards must be examined prior to making important design decisions. Field observations and laboratory research have determined that flooding with breaking waves between 1.5 and 3 feet high produces more damage than flooding of similar depths without waves. Therefore, ASCE 24, Flood Resistant Design and Construction, produced by the American Society of Civil Engineers' Structural Engineers Institute (ASCE/SEI, 2005) specifically requires application of the NFIP's V Zone design requirements in Coastal A Zones. The designers are advised to pay special attention to two additional considerations:

- Debris loads may be significant in Coastal A Zones landward of V Zones where damaged buildings, piers, and boardwalks can produce battering debris. Damage caused by debris can be minimized if foundations are designed to account for debris impact loads.
- Especially in high-wind regions, designers must pay special attention to the entire roof-to-foundation load path when designing and specifying

connections. To meet V Zone requirements, designs for buildings in Coastal A Zones should account for simultaneous wind and flood forces. Corrosion-resistant connections are especially important for the long-term integrity of the structure.

3.1.6 FLOODPLAIN MANAGEMENT REQUIREMENTS AND BUILDING CODES

The NFIP is the basis for the minimum requirements included in model building codes and standards for design and construction methods to resist flood damage. The original authorizing legislation for the NFIP is the National Flood Insurance Act of 1968 (42 U.S.C. 4001 et seq.). In that act, Congress expressly found that “a program of flood insurance can promote the public interest by encouraging sound land use by minimizing exposure of property to flood losses...”

The most convincing evidence of the effectiveness of the NFIP minimum requirements is found in flood insurance claim payment statistics. Buildings that pre-date the NFIP requirements are, by and large, not constructed to resist flood damage. Buildings that post-date the NFIP (i.e., those that were constructed after a community joined the program and began applying the minimum requirements) are designed to resist flood damage. The NFIP reports that aggregate loss data indicate that buildings that meet the minimum requirements experience 70 percent less damage than buildings that pre-date the NFIP. There is ample evidence that buildings designed to exceed the minimum requirements are even less likely to sustain damage.

3.1.6.1 Overview of the NFIP

The NFIP is based on the premise that the Federal government will make flood insurance available in communities that agree to recognize and incorporate flood hazards in land use and development decisions. In some States and communities, this is achieved by guiding development to areas with a lower risk. When decisions result in development within flood hazard areas, application of the criteria set forth in Federal regulation 44 CFR Part 60.3 are intended to minimize exposure and flood-related damage. State and local governments are responsible for applying the provisions of the NFIP through the regulatory permitting processes. At the Federal level, the NFIP is managed by FEMA and has three main elements:

- Hazard identification and mapping, under which engineering studies are conducted and flood maps are prepared in partnership with States

and communities. These maps delineate areas that are predicted to be subject to flooding under certain conditions.

- Floodplain management criteria for development establish the minimum requirements to be applied to development within mapped flood hazard areas. The intent is to recognize flood hazards in the entire land development process.
- Flood insurance, which provides some financial protection for property owners to cover flood-related damage to buildings and contents.

Federal flood insurance is intended to shift some of the costs of flood disasters away from the taxpayer by providing property owners an alternative to disaster assistance and disaster loans. Disaster assistance provides limited funding for repair and cleanup, and is available only after the President signs a major disaster declaration for the area. NFIP flood insurance claims are paid any time damage from a qualifying flood event³ occurs, regardless of whether a major disaster is declared. Community officials should be aware that public buildings may be subject to a mandated reduction in disaster assistance payments if the building is in a mapped flood hazard area and is not covered by flood insurance.

“Substantial damage” is damage of any origin sustained by a structure whereby the cost of restoring the structure to its condition before the damage would equal or exceed 50 percent of the market value of the structure before the damage occurred.

“Substantial improvement” is any repair, reconstruction, rehabilitation, addition, or improvement of a building, the cost of which exceeds 50 percent of the market value of the building before the improvement or repair is started (certain historic structures may be excluded).

Another important objective of the NFIP is to break the cycle of flood damage. Many buildings have been flooded, repaired or rebuilt, and flooded again. Before the NFIP, in some parts of the country this cycle was repeated every couple of years, with reconstruction taking place in the same flood-prone areas, using the same construction techniques that did not adequately resist flood damage. NFIP provisions guide development to lower-risk areas by requiring compliance with performance measures to minimize exposure of new buildings and buildings that undergo major renovation or expansion (called “substantial improvement” or repair of “substantial damage”). This achieves the long-term objective of building disaster-resistant communities.

³ For the purpose of adjusting claims for flood damage, the NFIP defines a flood as “a general and temporary condition of partial or complete inundation of two or more acres of normally dry land area or of two or more properties (at least one of which is the policyholder’s property) from: overflow of inland or tidal waters; unusual and rapid accumulation or runoff of surface waters from any source; mudflow; or collapse or subsidence of land along the shore of a lake or similar body of water as a result of erosion or undermining caused by waves or currents of water exceeding anticipated cyclical levels that result in a flood as defined above.”

3.1.6.2 Summary of the NFIP Minimum Requirements

The performance requirements of the NFIP are set forth in Federal regulation 44 CFR Part 60. The requirements apply to all development, which the NFIP broadly defines to include buildings and structures, site work, roads and bridges, and other activities. Buildings must be designed and constructed to resist flood damage, which is primarily achieved through elevation (or floodproofing). Additional specific requirements apply to existing development, especially existing buildings. Existing buildings that are proposed for substantial improvement, including restoration following substantial damage, are subject to the regulations.

Although the NFIP regulations primarily focus on how to build structures, one of the long-term objectives of the program is to guide development to less hazardous locations. Preparing flood hazard maps and making the information available to the public is fundamental in satisfying that objective. With that information, people can make informed decisions about where to build, how to use site design to minimize exposure to flooding, and how to design buildings that will resist flood damage.

The NFIP's broad performance standards for site work in flood hazard areas include the following requirements.

- Building sites shall be reasonably safe from flooding.
- Adequate site drainage shall be provided to reduce exposure to flooding.
- New and replacement sanitary sewage systems shall be designed to minimize or eliminate infiltration of floodwaters into the systems and discharges from the systems into floodwaters.
- Development in floodways shall be prohibited, unless engineering analyses show that there will be no increases in flood levels.

The NFIP's broad performance standards for new buildings proposed for flood hazard areas (and substantial improvement of existing flood-prone buildings) include the following requirements.

- Buildings shall be designed and adequately anchored to prevent flotation, collapse, or lateral movement resulting from hydrodynamic and hydrostatic loads, including the effects of buoyancy.
- Building materials used below the DFE shall be resistant to flood damage.

- Buildings shall be constructed by methods and practices that minimize flood damage (primarily by elevating to or above the base flood level, or by specially designed and certified floodproofing measures).
- Buildings shall be constructed with electrical, heating, ventilation, plumbing, and air conditioning equipment and other service facilities that are designed and/or located so as to prevent water from entering or accumulating within the components.

Owners, planners, and designers should determine if there are any applicable State-specific requirements for floodplain development. Some States require that local jurisdictions apply standards that exceed the minimum requirements of the NFIP. In particular, some States require that hospitals be located outside of the floodplain (including the 500-year floodplain) or they are to be designed and constructed to resist conditions associated with the 500-year flood. Some States have regulations that impose other higher standards, while some States have direct permitting authority over certain types of construction or certain types of applicants.

As participants in the NFIP, States are required to ensure that development not subject to local regulations, such as the development of State-owned properties, satisfies the same performance requirements. If hospitals are exempt from local permits, this may be accomplished through a State permit, a governor's executive order, or other mechanisms that apply to entities not subject to local authorities.

States often use governors' executive orders to influence State-constructed and State-funded critical facilities, requiring location outside of the 500-year floodplain where feasible, or protection to the 500-year flood level if avoiding the floodplain is not practical. In 2004, a review of State and local floodplain management programs determined that Alabama, Illinois, Michigan, New York, North Carolina, Ohio, and Virginia have requirements for critical facilities (ASFPM 2004).

3.1.6.3 Executive Order 11988 and Critical Facilities

When Federal funding is provided for the planning, design, and construction of new critical facilities (including hospitals), or for the repair of existing critical facilities that are located within the 500-year floodplain, the funding agency is required to address additional considerations. Executive Order 11988, Floodplain Management, requires Federal agencies to apply a decisionmaking process to avoid, to the extent possible, the long- and short-term adverse impacts associated with the occupancy and modification of floodplains, and to avoid the direct or indirect support of floodplain development whenever there is a practicable alternative. If there is no practicable alternative, the Federal agency must take steps to minimize any adverse impacts to life, property, and the natural and beneficial functions of floodplains.

The executive order establishes the BFE as the minimum standard for all Federal agencies. Implementation guidance specifically addresses “critical actions,” which are described as those actions for which even a slight chance of flooding would be too great. The construction or repair of critical facilities, such as hospitals and clinics, fire stations, emergency operations centers, and facilities for storage of hazardous wastes or storage of critical records, are examples of critical actions.

After determining that a site is in a mapped flood hazard area, and after giving public notice, the Federal funding agency is required to identify and evaluate practicable alternatives to locating a hospital in a 500-year

FEMA’s eight-step decisionmaking process for complying with Executive Order 11988 must be applied before Federal disaster assistance is used to repair, rehabilitate, or reconstruct damaged existing critical facilities in the 500-year floodplain.

floodplain. If the Federal agency has determined that the only practicable alternative is to proceed, then the impacts of the proposed action must be identified. If the identified impacts are harmful to people, property, and the natural and beneficial functions of the floodplain, the Federal agency is required to minimize the adverse effects on the floodplain and the funded activity.

Having identified the impacts of the proposed action and the methods to minimize these impacts, the Federal agency is required to re-evaluate the proposed action. The re-evaluation must consider whether the action is still feasible, whether the action can be modified to relocate the facility or eliminate or reduce identified impacts, or if a “no action” alternative should be chosen. If the finding results in a determination that there is no practicable alternative to locating a critical facility in the floodplain, or otherwise affecting the floodplain, then a statement of findings and a public explanation must be provided.

3.1.6.4 Scope of Model Building Codes and Standards

The *International Building Code (IBC)* and the *Building Construction and Safety Code (NFPA 5000)* were the first model codes to include comprehensive provisions that addressed flood hazards. Both codes are consistent with the minimum provisions of the NFIP that pertain to the design and construction of buildings. The NFIP requirements that pertain to site development, floodways, coastal setback lines, erosion-prone areas, and other environmental constraints are found in other local ordinances. The codes require designers to identify and design for anticipated environmental loads and load combinations, including wind, seismic, snow, and flood loads, as well as the soil conditions.

The IBC and NFPA 5000 incorporate, by reference, a number of standards that are developed through a formal or accredited consensus process. The best known is ASCE 7. The model building codes require that applicable loads be accounted for in the building design. The designer must identify the pertinent, site-specific characteristics and then use ASCE 7 to determine the specific loads and load combinations. In effect, it is similar to a local floodplain ordinance that requires determination of the environmental condition (in/out of the mapped flood hazard area, DFE/depth of water), and then specifies certain conditions that must be met during design and construction. The 1998 edition of ASCE 7 was the first version of the standard to include flood loads explicitly, including hydrostatic loads, hydrodynamic loads (velocity and waves), and debris impact loads.

The IBC and NFPA 5000 also incorporate, by reference, a standard that was first published by ASCE in 1998 and revised in 2005: ASCE 24. Developed through a consensus process, ASCE 24 addresses specific topics pertinent to designing buildings in flood hazard areas, including floodways, coastal high-hazard areas, and other high-risk flood hazard areas such as alluvial fans, flash flood areas, mudslide areas, erosion-prone areas, and high-velocity areas.

ASCE 7 and the model building codes classify structures based on occupancy into four categories, each with different requirements. The same categories are used in ASCE 24 and different flood-resistant requirements apply to the different categories. Table 3-1 summarizes the elevation requirements of ASCE 24 that exceed the NFIP minimum requirements for the hospitals and health care facilities addressed by this manual (Category III or Category IV structures).

ASCE 7-05 outlines methods to determine design loads and load combinations in flood hazard areas, including hydrostatic loads, hydrodynamic loads, wave loads, and debris impact loads. In order to compute the loads and load combinations the designer must identify site-specific characteristics, including flood depths, velocities, waves, and the likelihood that debris impacts need to be considered.

ASCE 24-05 addresses design requirements for structures in coastal high-hazard areas (V Zones) and Coastal A Zones.

Although most State and local building codes are based on the International Code Series produced by the International Code Council, jurisdictions often adopt specific amendments. For example, the State of Florida adopted requirements that are specific to nursing homes, new hospitals, and additions, alterations, or renovations to existing hospitals and all detached outpatient facilities. Such facilities are required to be “located above the 100-year flood plain or hurricane Category 3 (Saffir-Simpson scale) hurricane surge inundation elevation, whichever requires the highest elevation.”

Table 3-1: ASCE/SEI 24-05 provisions related to the elevation of hospitals

	Category III	Category IV
Elevation of Lowest Floor or Bottom of Lowest Horizontal Structural Member		
A Zone: elevation of lowest floor	BFE +1 ft or DFE, whichever is higher	BFE +2 ft or DFE, whichever is higher
V Zone and Coastal A Zone: where the lowest horizontal structural member is parallel to direction of wave approach	BFE +1 ft or DFE, whichever is higher	BFE +1 ft or DFE, whichever is higher
V Zone and Coastal A Zone: where the lowest horizontal structural member is perpendicular to direction of wave approach	BFE +2 ft or DFE, whichever is higher	BFE +2 ft or DFE, whichever is higher
Elevation Below which Flood-Damage-Resistant Materials Shall be Used		
A Zone	BFE +1 ft or DFE, whichever is higher	BFE +2 ft or DFE, whichever is higher
V Zone and Coastal A Zone: where the lowest horizontal structural member is parallel to direction of wave approach	BFE +2 ft or DFE, whichever is higher	BFE +2 ft or DFE, whichever is higher
V Zone and Coastal A Zone: where the lowest horizontal structural member is perpendicular to direction of wave approach	BFE +3 ft or DFE, whichever is higher	BFE +3 ft or DFE, whichever is higher
Minimum Elevation of Utilities and Equipment		
A Zone	BFE +1 ft or DFE, whichever is higher	BFE +2 ft or DFE, whichever is higher
V Zone and Coastal A Zone: where the lowest horizontal structural member is parallel to direction of wave approach	BFE +2 ft or DFE, whichever is higher	BFE +2 ft or DFE, whichever is higher
V Zone and Coastal A Zone: where the lowest horizontal structural member is perpendicular to direction of wave approach	BFE +3 ft or DFE, whichever is higher	BFE +3 ft or DFE, whichever is higher
Dry Floodproofing		
A Zone: elevation to which dry floodproofing extends	BFE +1 ft or DFE, whichever is higher	BFE +2 ft or DFE, whichever is higher
V Zone and Coastal A Zone: dry floodproofing not allowed	Not applicable	Not applicable

3.2 HOSPITALS EXPOSED TO FLOODING

3.2.1 IDENTIFYING FLOOD HAZARDS AT EXISTING HOSPITALS

Facility owners, planners, and designers of hospitals should investigate site-specific flood hazards and characteristics as part of site selection, guiding the location of a new hospital and other improvements on a site. This same investigation should be undertaken when examining existing hospitals and when planning improvements or rehabilitation work. The best available information should be examined, including flood hazard maps, records of historical flooding, storm surge maps, and advice from local experts and others who can evaluate flood risks. Table 3-3 in Section 3.5 outlines questions that should be answered prior to initiating site layout and design work.

3.2.2 VULNERABILITY: WHAT FLOODING CAN DO TO EXISTING HOSPITALS

Existing flood-prone hospitals are susceptible to damage, the nature and severity of which is a function of site-specific flood characteristics. Damage may include: site damage, structural and nonstructural building damage, destruction or impairment of utility service equipment, and loss of contents.

Regardless of the nature and severity of damage, flooded hospitals typically are not functional while cleanup and repairs are undertaken. The length of closure, and thus the impact on the ability of the facility to become operational, depends on the severity of the damage and lingering health hazards. Sometimes repairs are put on hold pending a decision on whether a hospital should be rebuilt at the flood-prone site. When damage is substantial, rehabilitation or reconstruction is allowed only if compliance with flood-resistant design requirements is achieved (see Section 3.1.6.2).

3.2.2.1 Site Damage

The degree of site damage associated with flooding is a function of several variables related to the characteristics of the flood, as well as the site itself.

Erosion and scour: All parts of a site that are subject to flooding by fast-moving water could experience erosion, and local scour could occur around any permanent obstructions to flow. Graded areas, filled areas, and cut or fill slopes are especially susceptible. Stream and channel bank erosion, and erosion of coastal shorelines, are natural phenomena that may, over time, threaten site improvements and buildings (see Figure 3-12).

Figure 3-12: Riverbank erosion of the Genesee River during Hurricane Agnes flooding in 1972 eventually led to collapse of this wing of the Jones Memorial Hospital, Wellsville, NY.

SOURCE: DICK NEAL PHOTOGRAPHY



Debris and sediment removal: Even when buildings are not subject to water damage, floods can deposit large quantities of debris and sediment that can damage a site and be expensive to remove.

Landscaping: Grass, trees, and plants suffer after floods, especially long-duration flooding that prevents oxygen uptake, and coastal flooding that stresses plants that are not salt-tolerant. Fast-moving floodwaters and waves also can uproot plants and trees.

Fences: Some types of fences that are relatively solid can significantly restrict the free flow of floodwaters and trap floating debris. Fences can be damaged or knocked down by the pressure of flowing water, or by the buildup of debris that may result in significant loads.

Accessory structures: Accessory structures can sustain both structural and nonstructural damage. In some locations, such structures can be designed

and built using techniques that minimize damage potential, without requiring elevation above the DFE.

Access roads: Access roads that extend across flood-prone areas may be damaged by erosion, washout of drainage culverts, failure of fill and bedding materials, and loss of road surface (see Figure 3-13). Road damage could prevent uninterrupted access to a facility and thus impair its functionality.



Figure 3-13:

Flooding caused the failure of this road bed.

SOURCE: U.S. ARMY CORPS OF ENGINEERS

Parking lots and parking garages: Paved parking lots may be damaged by failure of bedding materials and loss of driving surface. Vehicles left in parking lots and parking garages could also be damaged. Most large parking garages are engineered structures that can be designed to allow for the flow of water.

Helicopter landing pads: Helicopters landing pads that are flooded are not serviceable when access is critical. Hospitals on flood-prone sites should have rooftop landing pads.

Signage: Signage on ground that is subject to flooding may be damaged. Loss of signage can impair ready access, especially by those unfamiliar with the facility or on large medical campuses.

Damage to other site elements such as water supply, sewer lines, underground and aboveground tanks, and emergency power generators, is discussed in Section 3.2.2.5.

Stormwater management facilities and site drainage: Site improvements such as swales and stormwater basins may be eroded, filled with sediments, or clogged by debris.

3.2.2.2 Structural Damage

Structural damage includes all damage to the load-bearing portions of a building. Damage to other components of buildings is described below, including nonstructural components (Section 3.2.2.3), medical equipment (Section 3.2.2.4), utility service equipment (Section 3.2.2.5), and contents (Section 3.2.2.6).

Depth: The hydrostatic load against a wall or foundation is directly related to the depth of water. Standard stud and siding, or unreinforced brick veneer walls, may collapse under hydrostatic loads associated with relatively shallow water. Reinforced masonry walls perform better than unreinforced masonry walls (see Figure 3-14), although an engineering analysis is required to determine performance. Walls and floors of below-grade areas (basements) are particularly susceptible to damage by buoyancy force. When soils are saturated, pressures against below-grade walls are a function of the total depth of water, including the depth below-grade and the weight of the saturated soils.

Figure 3-14: Interior unreinforced masonry walls of the Port Sulphur High School in Louisiana were damaged by hydrostatic loads associated with Hurricane Katrina's storm surge (2005).



Buoyancy and uplift: If below-grade areas are essentially watertight, buoyancy or uplift forces can float a building out of the ground or rupture concrete slabs-on-grade (see Figure 3-15). Buildings that are not adequately anchored can be floated or pushed off foundations. Although rare for large and heavy buildings, this is a concern for smaller structures. Buoyancy is a significant concern for underground and aboveground tanks, especially those used for emergency generator fuel and bulk oxygen.



Figure 3-15: Concrete slab ruptured by hydrostatic pressure (buoyancy) induced by the floodwaters of Hurricane Katrina (2005).

Duration: By itself, saturation is unlikely to result in significant structural damage to masonry construction. Saturation of soils, a consequence of long duration flooding, increases pressure on below-grade foundation walls.

Velocity, wave action, and debris impacts: Each of these components of dynamic loads can result in structural damage if buildings are not designed to resist overturning, repetitive pounding by waves, or short-duration impact loads generated by floating debris (see Figure 3-16).

Erosion and scour: Structural damage is associated with foundation failure when erosion or scour results in partial or complete removal of supporting soil (see Figure 3-17). Erosion of slopes, especially unprotected slopes, can lead to slope failures and loss of foundation supporting soil.

Figure 3-16:
The South Cameron Memorial Hospital, Cameron, LA, was damaged by debris carried by Hurricane Rita's storm surge (2005).

SOURCE: LSU AG CENTER



Figure 3-17:
Local scour undermined the footing of this exterior stair tower (Hurricane Ivan, 2004).



3.2.2.3 Nonstructural Damage

Many flood-prone buildings are exposed to floodwaters that are not fast moving, or that may be relatively shallow and not result in structural damage. Simple inundation and saturation of the building and finish materials can result in significant and costly damage, including long-term health complications associated with mold. Floodwaters often are con-

taminated with chemicals, petroleum products, and sewage. Under such circumstances, recovery generally involves removal of nonstructural materials and finishes because cleanup and decontamination are expensive and time-consuming (see Figure 3-18). Damage to contents is discussed in Section 3.2.2.6.



Figure 3-18:
Drying out the ground
floor at Hancock
Medical Center
(Hurricane Katrina,
2005)

SOURCE: HANCOCK MEDICAL
CENTER

Saturation damage can vary as a function of the duration of exposure. Some materials are not recoverable even after very brief inundation, while others remain serviceable if in contact with water for only a few hours. Use of water-resistant materials will help to minimize saturation damage and reduce the costs of cleanup and restoration to service. (For more information, see FEMA Technical Bulletin FIA-TB-2, Flood-Resistant Materials Requirements.)

Wall finishes: Painted concrete and concrete masonry walls usually resist water damage, provided the type of paint used can be readily cleaned. Tiled walls may resist water damage depending on the type of adhesive and foundation (gypsum board substrate and wood-framed walls with tile typically do not remain stable).

Flooring: Many hospitals have durable floors that resist water damage. Ground floors are often slab-on-grade and finished with tile or sheet products. Flooring adhesives in use since the early 1990s likely are latex-based and tend to break down when saturated (see Figure 3-19). Most carpeting, even the indoor-outdoor kind, is difficult to clean.

Figure 3-19:
Floor damage at West
Jefferson Medical
Center (Hurricane
Katrina, 2005)



Wall and wood components: When soaked for long periods of time, some materials change composition or shape. Most types of wood swell when wet and, if dried too quickly, will crack, split, or warp. Plywood can delaminate and wood door and window frames may swell and become unstable. Gypsum wallboard, wood composition panels, other wall materials, and wood cabinetry not intended for wet locations can fall apart (see Figure 3-18). The longer these materials are wet, the more moisture, sediment, and pollutants they absorb. Some materials, such as the paper facing on gypsum wallboard, “wick” standing water, resulting in damage above the actual high-water line (see Figure 3-20).

Figure 3-20:
The test of the effects of
flooding on materials
showed that water
damage and mold
growth extended
above the water line.

SOURCE: OAK RIDGE
NATIONAL LABORATORY

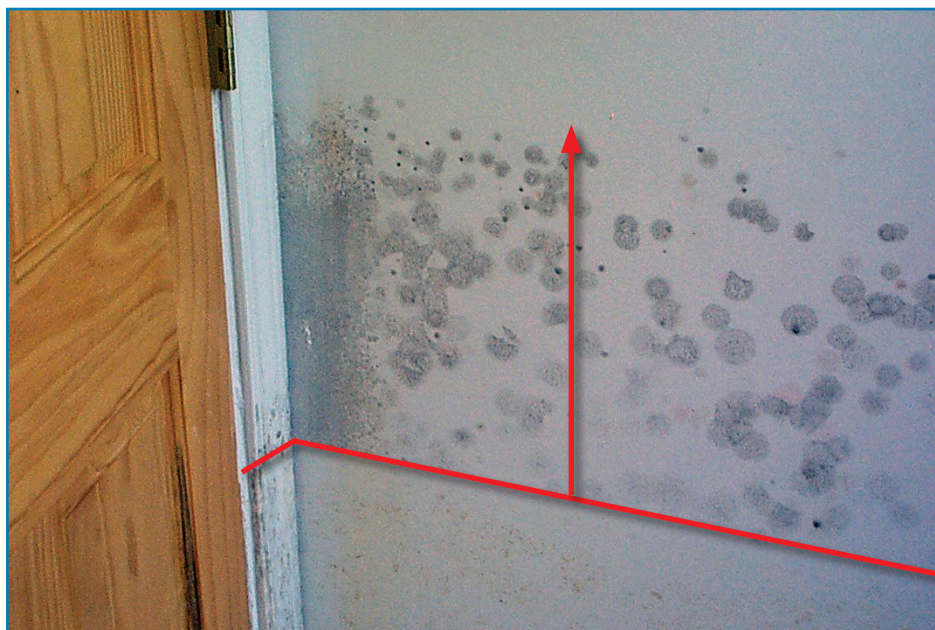

Metal components: Metal structural components are unlikely to be permanently damaged by short-term inundation. However, hollow metal partitions are particularly susceptible when in contact with water because they cannot be thoroughly dried and cleaned. Depending on the degree of corrosion protection on the metal, repetitive flooding by saline coastal waters may contribute to long-term corrosion.

Metal connectors and fasteners: Depending on the composition of the metal, repetitive flooding, especially by saline coastal waters, may contribute to long-term corrosion. Connectors and fasteners are integral to the structural stability of buildings; therefore, failure caused by accelerated corrosion would jeopardize the building.

3.2.2.4 Medical Equipment

Large medical equipment that is permanently installed usually is considered to be part of the building rather than contents. The nature and sensitivity of most medical equipment suggests that post-flood cleaning to restore functionality may not be feasible. This limits options for existing hospitals that use such equipment in areas that will be exposed to flooding, because temporary relocation of the equipment cannot be part of an emergency response plan.

3.2.2.5 Utility System Damage

Utility system service equipment that is exposed to flooding is vulnerable to damage. Damage may result in a total loss, or may require substantial cleaning and restoration efforts. The degree of damage varies somewhat as a function of the characteristics of flooding. Certain types of equipment and installation measures will help minimize damage and reduce the costs of cleanup and restoration to service.

Displacement of equipment and appliances: Installation below the flood level exposes equipment and appliances to flood forces, including drag resulting from flowing water and buoyancy. Gas-fired appliances are particularly dangerous: flotation can separate appliances from gas sources, resulting in fires and explosive situations. Displaced equipment may dislodge lines from fuel oil tanks, contributing to the threat of fire and causing water pollution and environmental damage.

Elevators: If located in areas subject to flooding, elevator component equipment and controls will be damaged, and movement between floors will be impaired. In hospitals, maintaining elevator function is important, especially if services have to be consolidated to upper floors after a flood.

Corrosion: Corrosion related to inundation of equipment and appliances may not be apparent immediately, but can increase maintenance demand and shorten the useful life of some equipment and appliances.

Electrical systems and components: Electrical systems and components, and electrical controls of heating, ventilation and air-conditioning systems, are subject to damage simply by getting wet, even for short durations. Unless specifically designed for wet locations, switches and other electrical components can short out due to deposits of sediment, or otherwise not function, even when allowed to dry before operation. Wiring and components that have been submerged may be functional, although generally it is more cost-effective to discard flooded outlets, switches, and other less-expensive components than to attempt thorough cleaning.

Communications infrastructure: Critical communications infrastructure, such as control panels and wiring for warning systems, 911 systems, and regular telephone and wireless networks, are most susceptible to failure during emergencies if located in below-grade basements.

Specialized piping: Unprotected piping for medical gas supply systems may be damaged and threaten care that depends on an uninterrupted supply of oxygen and other gasses for the treatment of patients.

Ductwork damage: Ductwork is subject to two flood-related problems. Flood forces can displace ductwork, and saturated insulation can overload support straps, causing failure.

Mold and dust: Furnaces, air handlers, and ductwork that have been submerged must be thoroughly cleaned and sanitized. Otherwise, damp conditions contribute to the growth of mold and accumulated sediment can be circulated throughout the hospital, causing respiratory problems. Fiberglass batt or cellulose insulation that has been submerged cannot be sanitized and must be replaced. In sensitive environments, ductwork should be replaced rather than cleaned.

Gas-fired systems: Water-borne sediment can impair safe functioning of jets and controls in gas-fired furnaces and water heaters, necessitating professional cleaning and inspection prior to restoration of service. Control equipment (valves, electrical switches, relays, temperature sensors, circuit breakers, and fuses) that have been submerged may pose an explosion and fire hazard and should be replaced.

Emergency power generators: Generators that are installed at-grade are susceptible to inundation and will be out of service after a flood (see Figure 3-21). Even if fuel tanks are located above flood level, truck access for refueling would be impaired if the site is flooded for any length of time.



Figure 3-21: Although it was anchored and not displaced by floodwaters, this generator was out of service after being submerged (Hurricane Katrina, 2005).

Tanks (underground): Underground storage tanks are subjected to significant buoyant forces and can be displaced, especially when long-duration flooding occurs. Computations of stability should be based on the assumption that the tank is empty in order to maximize safety. Tank inlets, fill openings, and vents should be above the DFE, or designed to prevent the inflow of floodwaters or outflow of tank contents during flood conditions.

Tanks (aboveground): Permanently installed aboveground storage tanks are subject to buoyant forces and displacement caused by moving water. Standard strapping of propane tanks may be inadequate for the anticipated loads. Tank inlets, fill openings, and vents should be above the DFE, or designed to prevent the inflow of floodwaters or outflow of tank contents during flood conditions. Even temporary storage of tanks can be problematic (see Figure 3-22).

Figure 3-22:

Oxygen tanks stored outside of the Hancock Medical Center were dislodged by flooding (Hurricane Katrina, 2005).



Public Utility Service: Damage to public utility service (potable water supply and wastewater collection) can affect operations and may cause damage to hospitals:

- Potable water supply systems may become contaminated if distribution lines or treatment facilities are damaged, or if wellheads are submerged.
- During heavy rains, sewers back up from infiltration and inflow of stormwater into the sewer lines and manholes, cross connections between storm and sanitary sewers, and flooded wastewater treatment plants. Sewer backup into a hospital poses a major health hazard. Even when the water has receded, exposed building components, finish materials, and contents are contaminated, and usually must be removed because adequate cleaning is difficult, if not impossible.

3.2.2.6 Contents Damage

Hospitals contain high-value equipment and contents that can be damaged and unrecoverable when exposed to flooding. For the purpose of this discussion, the term “contents” includes items such as furniture, appliances, computers, laboratory equipment and materials, records, and specialized moveable machinery. The following types of contents often are total losses after flooding.

Furniture: Porous woods become saturated and swollen, and joints may separate. Furniture with coverings or pads generally cannot be restored. Metal furniture is difficult to thoroughly dry and clean, is subject to cor-

rosion, and typically is discarded (see Figure 3-23). Some wood furniture may be recoverable after brief inundation.

Computers: Flood-damaged computers and peripheral equipment cannot be restored after inundation, although special recovery procedures may be able to recover information on hard drives.



Figure 3-23: The interior of the Hancock Medical Center required extensive cleanup following flooding (Hurricane Katrina, 2005).

SOURCE: HANCOCK MEDICAL CENTER

Communications equipment: Even though some communications equipment may be able to be restored with appropriate cleaning, the loss of functionality would seriously impair the ability of the facility to provide critical services immediately after a flood. Equipment with printed circuit boards generally cannot be restored.

Medical records and office files: Valuable records may be lost if flooded. Although expensive, some recovery of computerized and paper records may be possible with special procedures (see Figure 3-24).

Health care equipment and laboratory materials: Most medical and health care equipment cannot be cleaned and restored to safe functioning, and would need to be replaced. Depending on the nature of laboratory materials and chemicals, complete disposal or special cleanup procedures may be required.

Kitchen equipment and goods: Floodwaters can dislodge appliances that can float and damage other equipment. Stainless steel equipment generally

has cleanable surfaces that can be disinfected and restored to service. Because of contamination, all food stuffs must be discarded.

Vehicles associated with hospitals: If left in flood-prone areas, vehicles must be replaced or cleaned to be serviceable, and may not be functional and available for service immediately after a flood.

Figure 3-24: Medical records saturated by floodwaters (Hurricane Katrina, 2005)

SOURCE: HANCOCK MEDICAL CENTER



3.3 REQUIREMENTS AND BEST PRACTICES IN FLOOD HAZARD AREAS

3.3.1 EVALUATING RISK AND AVOIDING FLOOD HAZARDS

Flood hazards are very site-specific. When a flood hazard map is prepared, lines drawn on the map appear to define the hazard area precisely. Land that is on one side of the line is “in” the mapped flood hazard area, while the other side of the line is “out.” Although the delineation may be an approximation, having hazard areas shown on a map facilitates avoiding such areas to the maximum extent practical. If such areas are unavoidable, facility owners should carefully evaluate all of the benefits and all of the costs in order to determine long-term acceptable risks, and to develop appropriate plans for design and construction of new facilities.

Even in communities with expansive floodplains, it should be possible to avoid locating new hospitals in floodways and coastal areas subject to significant waves (V Zones).

Section 3.2 describes the damage sustained by existing buildings exposed to flood hazards, including site damage, structural and nonstructural building damage, destruction or impairment of service equipment, and loss of contents. These types of damage, along with loss of function, are avoided if hospitals are located away from flood hazard areas. Damage is reduced and the ability to sustain function is increased when hospitals that must be located in flood hazard areas are built to exceed the minimum requirements.

Flood hazard areas designated as “V Zones” on FIRMs are relatively narrow areas along open coasts and lake shores where the base flood

Construction in V Zones is required to meet certain design and construction requirements that are different than those required in A Zones. This chapter will identify these differences.

conditions are expected to produce 3-foot or higher waves. V Zones, sometimes called coastal high-hazard areas or special flood hazard areas subject to high-velocity wave action, are found on the Pacific, Gulf, and Atlantic coasts, and around the Great Lakes. Every effort should be made to locate hospitals outside of V Zones, because the destructive nature of waves makes it difficult to design a building to be fully functional during and after a flood event. This is particularly true in coastal areas subject to hurricane surge flooding.

3.3.2 BENEFITS AND COSTS: DETERMINING ACCEPTABLE RISK

Many decisions made with respect to hospitals are, in part, based on a determination of acceptable risk. Risk includes the potential losses associated with a hazard. Ideally, risks can be defined in terms of expected probability and frequency of the hazard occurring, the people and property exposed, and the potential consequences. Choosing a site that is affected by flooding is a decision to accept some degree of risk. Although the flood-prone land may have a lower initial cost, the incremental costs of construction, plus the likely increased costs of maintenance, repair, and replacement, may be significant. Another cost of locating a hospital in a flood-prone area is related to access problems if streets and access roads are impassable. The building may be elevated and protected, but if access is restricted periodically, then the use of the facility is affected (see Figure 3-25).

Figure 3-25:
Hurricane Katrina's floodwaters surrounded most hospitals in New Orleans, complicating access for evacuation, as well as limiting treatment options for residents.



In communities with expansive flood hazard areas, there may be no practical alternatives to using a flood-prone site. In these situations, an evaluation of acceptable risk should lead to selection of design measures that exceed the minimum requirements to mitigate the impacts of flooding.

The building owner and the design team can influence the degree of risk (e.g., the frequency and severity of flooding that may affect the site). They control it through the selection of the site design and the building design measures. Fundamentally, this process is a balancing of the benefits of an acceptable level of disaster resistance with the costs of achieving that degree of protection. With respect to mitigation of future hazard events:

Extreme hurricane storm surge flooding may be a very low-probability event, but the flood depths and wave heights may be much more severe than the conditions of the base flood shown on the FIRMs. The potential impacts on a hospital must be carefully considered in order to make an informed decision regarding acceptable risk and potential damage. If possible, it is always best to avoid locating hospitals in areas subject to extreme storm surge flooding.

- Benefits are characterized and measured as future damages avoided if the mitigation measures (including avoiding flood hazard areas) are implemented.
- Costs are the costs associated with implementing measures to eliminate or reduce exposure to hazards.

Section 3.2 describes typical damage and losses sustained by buildings exposed to flooding. Direct damage includes damage to physical property, including the site, the building, building materials, utilities, and building contents. Indirect damage that is not listed includes health hazards, loss of functionality, emergency response, evacuation, expenses associated with relocating services to another building during repairs, and loss of revenue.

Benefits other than avoided physical damage are difficult to measure. They are associated with future damage that does not occur because of the mitigation activity, cleanup that is not required because of the mitigation activity, service that is not interrupted because flooding does not affect normal operations, and revenue that is not lost. In addition, benefits accrue over long periods of time, thus making it more difficult to make a direct comparison of the benefits with the up-front costs of mitigation. Mitigation costs can be more readily expressed in terms of the higher costs of a flood-free site, or the initial capital costs of work designed to resist flood damage. Thus, without full accounting of both benefits and costs, decisionmakers may not be able to make fully informed decisions. Some questions that should be answered include:

- If the site is flood-prone and the building is out of the flood hazard area or is elevated on fill, what are the average annual cleanup costs

associated with removal of sand, mud, and debris deposited by floods of varying frequencies?

- If the facility building is elevated by means other than fill, will periodic inundation of the exposed foundation elements cause higher average annual maintenance costs?
- If the facility is protected with floodproofing measures, what are the costs of annual inspection, periodic maintenance and replacement of materials, and staff training and drills?
- If the hospital meets only the minimum elevation requirements, what are the average annual damages and cleanup costs over the anticipated useful life of the building, including the occurrence of floods that exceed the design flood elevation?
- How do long-term costs associated with periodic inundation compare to up-front costs of selecting a different site or building to a higher level of protection?
- If a site outside of the flood hazard area is available but less than optimal in terms of access by the community, are the trade-offs acceptable?
- If the facility is located in a hurricane-prone community, how should the facility design account for low-probability, but high-impact, storm surge flooding?
- If access to the facility is periodically restricted by flooding, especially long-duration flooding, what are the resulting cost effects? How often would an alternate location need to be provided to continue normal operations?

3.3.3 SITE MODIFICATIONS

When sites being considered for hospitals are prone to flooding, planners and designers may want to evaluate the feasibility of certain site modifications in order to provide an increased level of protection to buildings. The evaluations involve engineering analyses to determine whether the desired level of protection is cost-effective, and whether the proposed site modifications alter the floodplain in ways that could increase flooding. The effectiveness of typical site modifications and their ramifications must be examined for each specific site.

Earthen fill: Fill can be placed in the flood hazard area to elevate an entire site above the DFE. If the fill is placed and compacted to be stable during

the rise and fall of floodwaters, and if the fill is protected from erosion, then modifying a site with fill to elevate a facility is preferred over other methods of elevation. Not only will buildings be less exposed to flood forces, but, under some circumstances (such as long duration floods), hospitals may be able to continue to function. Whether nonstructural fill is placed solely to modify the site, or structural fill is placed to elevate buildings, placement of fill can change flooding characteristics, including increased flooding on other properties. Engineering analyses can be conducted to determine whether eliminating floodplain storage by filling will change the direction of the flow of water, create higher flow velocities, or increase the water surface elevation in other parts of the floodplain.

Site modifications are not appropriate in floodways along riverine waterways, where obstructions to flows can increase flood elevations. Engineering analyses are required to determine the impact of such modifications.

In Coastal A Zones, back bays, and along the banks of wide rivers where wave action is anticipated, fill is a less-effective site modification method because wave action may erode the fill, and adequate armoring or other, protection methods can be expensive.

In V Zones, structural fill is not allowed as a method of elevating buildings. Beachfront areas with sand dunes pose special problems. Manmade alterations of sand dunes are not allowed unless analyses indicate that such modifications will not increase potential flood damage.

Excavation: Excavation on a given parcel of land alone rarely results in significant alteration of the floodplain. Excavation that modifies a site is more commonly used in conjunction with fill in order to offset or compensate for the adverse impacts of fill.

Earthen levee: A levee is a specially designed barrier that modifies the floodplain by keeping the water away from certain areas (see Figure 3-26). Levees are significant structures that require detailed, site-specific geotechnical investigations; engineering analyses to identify whether flooding will be made worse on other properties; structural and site design to suit existing constraints; design of interior drainage (on the land side); and long-term commitment for maintenance, inspection, and repairs. It is important to remember that areas behind levees are protected only up to a certain design flood level—once overtopped or breached, most levees fail and catastrophic flooding results. Levees that protect hospitals and other critical facilities usually are designed for at least the 0.2-percent-annual-chance flood (500-year) and have freeboard to increase the factor of safety. Depending on the site layout and duration of flooding, access for vehicles can be problematic. Low levees can be designed with road access;

higher levees can be designed with vehicle access points that require special closures when flooding is predicted.

Floodwall: Floodwalls are similar to levees in that they provide protection to certain areas (see Figure 3-26). Failure or overtopping of a floodwall can result in catastrophic flooding. A floodwall is a significant structure designed to hold back water of a certain depth based on the design flood for the site. Generally, floodwalls are most effective in areas with relatively shallow flooding and minimal wave action. As with levees, designs must accommodate interior drainage on the land side, and maintenance and operations are critical for adequate performance. Floodwalls that protect buildings that provide essential services usually are designed for the 0.2-percent-annual-chance flood (500-year) and have freeboard to increase the factor of safety. If a protected facility is intended to remain operational during long-duration flooding, vehicle access to the site and pedestrian access to the building are required.

Figure 3-26:
Schematic of typical earthen levee and permanent floodwall

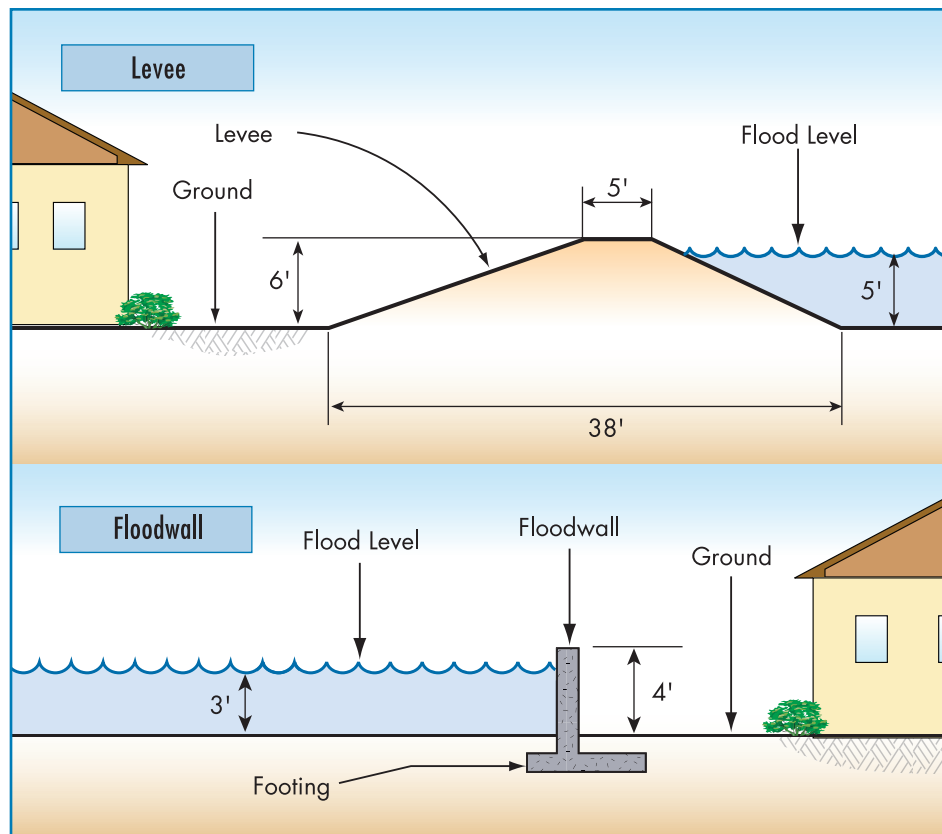

3.3.4 ELEVATION CONSIDERATIONS

The selection of the appropriate method of elevating a hospital in a special flood hazard area depends on many factors, including type of flood zone, costs, level of safety and property protection determined as acceptable risk, and others. Another consideration is the elevation of the lowest floor relative to the flood elevation. Table 3-1 in Section 3.1.6.4 summarizes the elevation requirements in ASCE 24. Given the importance of hospitals, elevation of the lowest floor to or above the 0.2 percent-annual-chance flood (500-year) elevation is crucial. Various methods used to elevate buildings in flood hazard areas are described below.

“Lowest floor” is the floor of the lowest enclosed area (including the basement). An unfinished or flood-resistant enclosure, usable solely for parking of vehicles, building access, or storage in an area other than a basement, is not the lowest floor, provided the enclosure is built in compliance with applicable requirements.

In A Zones, the minimum requirement is that the lowest floor (including the basement) must be at or above the DFE (plus freeboard, if desired or required). For building elevation methods other than fill, the area under elevated buildings in A Zones may be used only for limited purposes: parking, building access, and limited storage (crawlspaces are treated as enclosures, see below). Owners and designers are cautioned that enclosures below the DFE are exposed to flooding and the contents will be damaged or destroyed by floodwaters. The walls surrounding an enclosure must have flood openings that are intended to equalize interior and exterior water levels in changing flood conditions, to prevent differential hydrostatic pressures leading to structural damage. The enclosed area must not contain utilities and equipment (including ductwork) below the required elevation.

In a V Zone, the minimum requirement is that the elevation of the bottom of the lowest horizontal structural member of the lowest floor (including basement) must be at or above the DFE (plus freeboard, where required). Given the importance of hospitals, elevation to or above the 0.2-percent-annual-chance flood (500-year) elevation is appropriate and strongly recommended. The V Zone requirements are recommended in Coastal A Zones.

The area under elevated buildings in V Zones may be used only for parking, building access, and limited storage. The areas may be open

Communities that participate in the NFIP require that a registered professional engineer or architect develop or review the structural design, specifications, and plans of buildings in V Zones, and certify that the design and methods of construction to be used are in accordance with accepted standards of practice. The standards of practice require that the foundation and structure attached thereto is anchored to resist flotation, collapse, and lateral movement caused by wind and water loads acting simultaneously on all building components. Water loading values are those associated with the base flood conditions, and wind loading values are those required by applicable State or local building codes and standards.

or enclosed by lattice walls or screening. If areas are enclosed by solid walls, the walls must be specifically designed to break away under certain flood loads to allow the free passage of floodwaters under the building. Breakaway walls are non-load-bearing walls, i.e., they do not provide structural support for the building. They must be designed and constructed to collapse under the pressure of floodwaters in such a way that the supporting foundation system and the structure are not affected.

Coastal communities along the Atlantic and Gulf coasts are subject to storm surge flooding generated by hurricanes and tropical storms. Depending on a number of variables, storm surge flood depths may significantly exceed the BFE. In addition, waves are likely to be higher than predicted for the base flood, and will occur in areas where significant wave action during the base flood is not expected. Application of the minimum requirements related to elevation of the lowest floor and foundation design does not result in flood resistance for such extreme conditions. Foundations for hospitals in areas subject to storm surge should be designed to elevate the building so that the lowest horizontal structural members are higher than the minimum required elevation. Additional elevation not only reduces damage that results from lower probability events, but the cost of Federal flood insurance is usually lower. Designers and owners should plan to use the lowest elevated floor for non-critical uses that, even if exposed to flooding more severe than the design flood, will not impair critical functioning during post-flood recovery.

Storm surge flooding and waves can cause scour and erosion, even at locations that are some distance from the shoreline. Foundation designs for hospitals in coastal communities should account for some erosion and local scour of supporting soil during low-probability surge events. Storm surge flooding can also produce large quantities of floating debris, even at locations that are some distance from the shoreline. Debris can damage nonstructural building components and, in some cases of prolonged battering, can lead to structural failure. Foundation designs for hospitals in coastal communities should account for debris loads. This is especially important where damage to other buildings in the area may generate additional debris, thereby increasing the loads.

Notes on continuous load path: In coastal communities and other areas exposed to high winds, designers should pay special attention to the entire roof-to-foundation load path when designing and specifying connections. Connections must be capable of withstanding simultaneous wind and flood forces. Poorly connected buildings may fail or float off foundations when floodwaters and waves are higher than the design flood elevation. Corrosion-resistant connections are critical for the long-term integrity of the structure, and should be inspected and maintained regularly.

Slab-on-grade foundation on structural fill: This is considered to be the safest method to elevate a building in many flood hazard areas, except those where waves and high velocity flows may cause erosion. Consequently, this foundation type is not allowed in V Zones. Structural fill can be placed so that even if water rises up to the DFE, the building (see Figure 3-27) and building access would still be protected from flooding. The fill must be designed to minimize adverse impacts, such as increasing flood elevations on adjacent properties, increasing erosive velocities, and causing local drainage problems. To ensure stability, especially as floodwaters recede and the soils drain, fill must be designed for the anticipated water depths and duration. A geotechnical engineer or soil scientist may need to examine underlying soils to determine if the bearing capacity is sufficient to carry the added weight of fill, or if consolidation over time may occur. In addition, the effects of long-term compaction of the fill should be considered, and may prompt additional elevation as a factor of safety. The horizontal extent of the fill, away from the foundation, should be designed to facilitate access by emergency vehicles, with a minimum 25-foot width recommended. Engineered concrete slabs supported by piers should have sufficient resistance to erosion and scour if designed for anticipated flood conditions. Designers are cautioned to avoid excavating a basement into fill without added structural protection (and certification that the design meets the requirements for dry floodproofing), due to the potential for significant hydrostatic loads and uplift on basement floors.

Communities may require a registered design professional to certify that buildings elevated on fill are reasonably safe from flooding. The FEMA NFIP Technical Bulletin 10-01 discusses criteria for this certification.



Figure 3-27: Structural fill was placed to elevate the Henrietta Johnson Medical Center above the shallow flood hazard area in Wilmington, DE.

Stem wall foundations: Stem wall foundations have a continuous perimeter grade beam, or perimeter foundation wall, that is backfilled with compacted earth to the underside of the concrete floor slab (see Figure 3-28). This foundation type is not allowed in V Zones. Stem wall foundations are designed to come in contact with floodwaters on the exterior. They are more stable than perimeter wall foundations with crawlspaces, but could experience structural damage if undermined by local scour and erosion. Designs must account for anticipated debris and ice impacts, and incorporate methods and materials to minimize impact damage.

Figure 3-28:
Typical stem wall
foundation

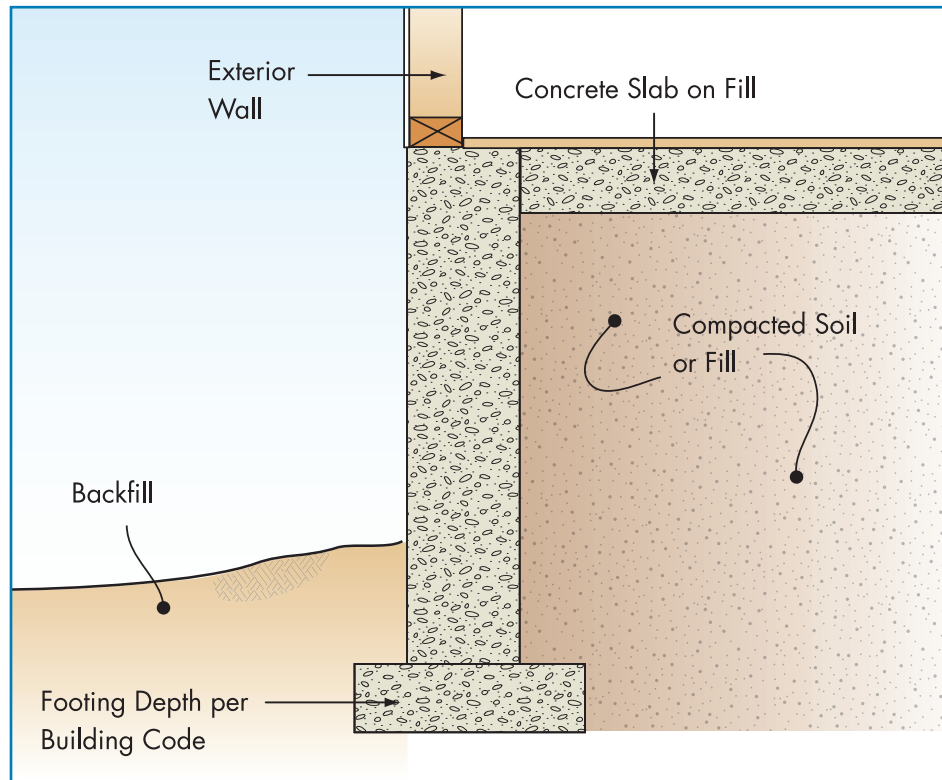

Columns or shear wall foundations (open foundations): Open foundations consist of vertical load-bearing members (columns, piers, pilings, and shear walls) without solid walls connecting the vertical members. Open foundations minimize changes to the floodplain and local drainage patterns, and the area under the building can be used for parking or other uses (see Figure 3-29). The design of the vertical members must also account for hydrodynamic loads and debris and ice impact loads. Flood loads on shear walls are reduced if they are oriented parallel to the anticipated direction of flow. If erodible soils are present and local scour is likely, both conditions must be accounted for in determining embedment depth. Depending on the total height of the elevated facility, the design may need to take into consideration the increased exposure to wind and uplift, particularly where loads are expected from breaking waves.

In V Zones, buildings must be elevated using open foundations, which consist of vertical load-bearing members (columns, piers, pilings, and shear walls) without solid walls connecting the vertical members. The design of the vertical members must also account for hydrodynamic loads and debris impact loads. Flood loads on shear walls are reduced if the walls are oriented parallel to the anticipated direction of flow. Erodible soils may be present and local scour may occur; both must be accounted for in designs by extending the load-bearing members and foundation elements well below the expected scour depth.

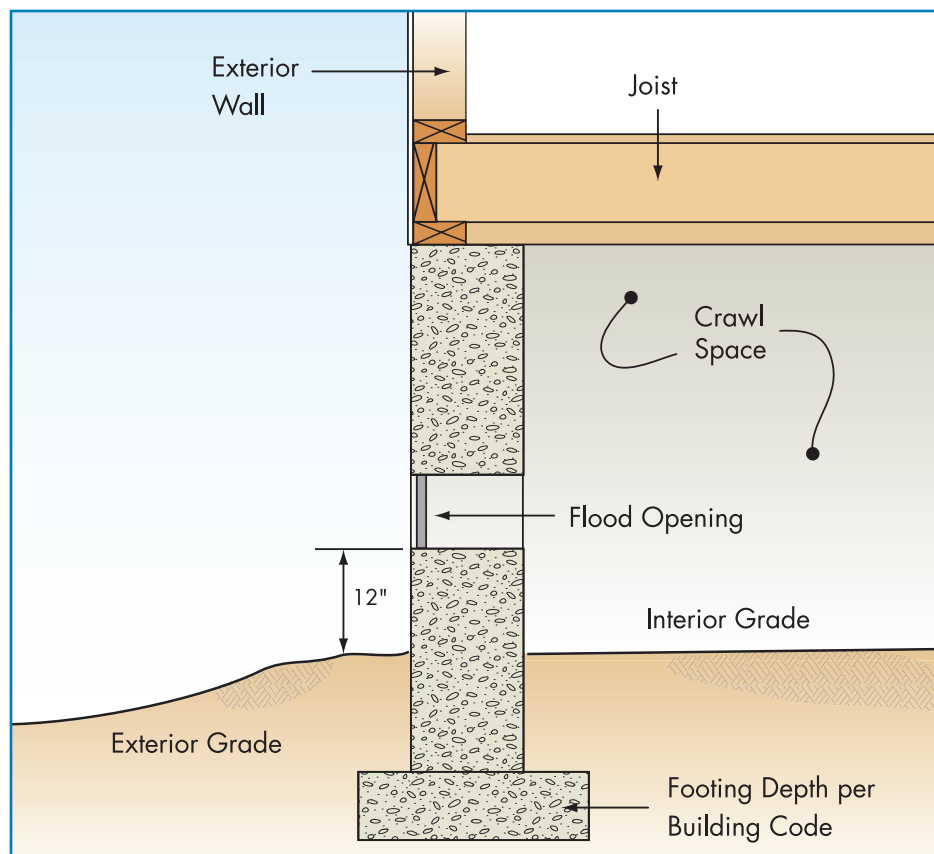

Figure 3-29: Tampa General Hospital had its new Emergency Department wing designed to be elevated on columns, well above hurricane storm surge flooding elevations.

SOURCE: TAMPA GENERAL HOSPITAL

Continuous perimeter walls (enclosed foundations with crawlspace): Unlike stem wall foundations, continuous perimeter walls enclose an open area or crawlspace (see Figure 3-30). The perimeter walls must have flood openings, also called vents) that are intended to equalize interior and exterior water levels automatically during periods of rising and falling flood levels, to prevent differential hydrostatic pressures that could lead to structural damage. Flood openings may be engineered and certified for the required performance, or they must meet prescriptive requirements (notably, the opening must provide at least 1 square inch of net open area for each square foot of area enclosed). Perimeter wall design must also account for hydrodynamic loads, and debris and ice impact loads. Enclosed crawlspaces must not contain utilities or equipment (including ductwork) below the required elevation. Designers must provide adequate underfloor ventilation and subsurface drainage to minimize moisture problems after flooding. This foundation type is not allowed in V Zones.

Figure 3-30:
Typical crawlspace
with flood openings



Pier supports for manufactured and portable units: Manufactured buildings and portable units must be elevated above the DFE (plus freeboard, if required). Pier supports must account for hydrodynamic loads and debris and ice impact loads, and units must be anchored to resist wind loads. Although written specifically for manufactured housing units, FEMA 85, *Manufactured Home Installation in Flood Hazard Areas*, has useful information that is applicable to portable units.

3.3.4.1 The Case of Boulder Community Foothills Hospital, Boulder, Colorado

Located on the east side of the City of Boulder, Colorado, the Boulder Community Foothills Hospital (BCFH) is framed by the Flatirons, the first of the Rocky Mountains rising steeply above the Front Range plains to the east. The new facility, completed in 2003 but not fully occupied until 2004, is an expansion of the existing Boulder Community Hospital located in the older part of the city.

The master site plan for complete development of the site is shown in Figure 3-31. The primary building on the site incorporates the hospital

and medical building. It consists of a main reception area linking two large wings. The hospital wing is cast-in-place concrete with a steel frame roof. The medical building wing is steel frame, fireproofed with concrete floor slabs. Exteriors are brick veneer on metal studs. The two wings have three floors above-grade and one floor below-grade. The original designs complied with the 1997 Uniform Building Code for the core and shell; clinical spaces and interior designs comply with the 2000 *International Building Code*. Other buildings on the campus include the Table Mesa Medical Building, a free-standing parking garage, and the utility plant building. The Cancer Care Center and another parking garage are under construction.

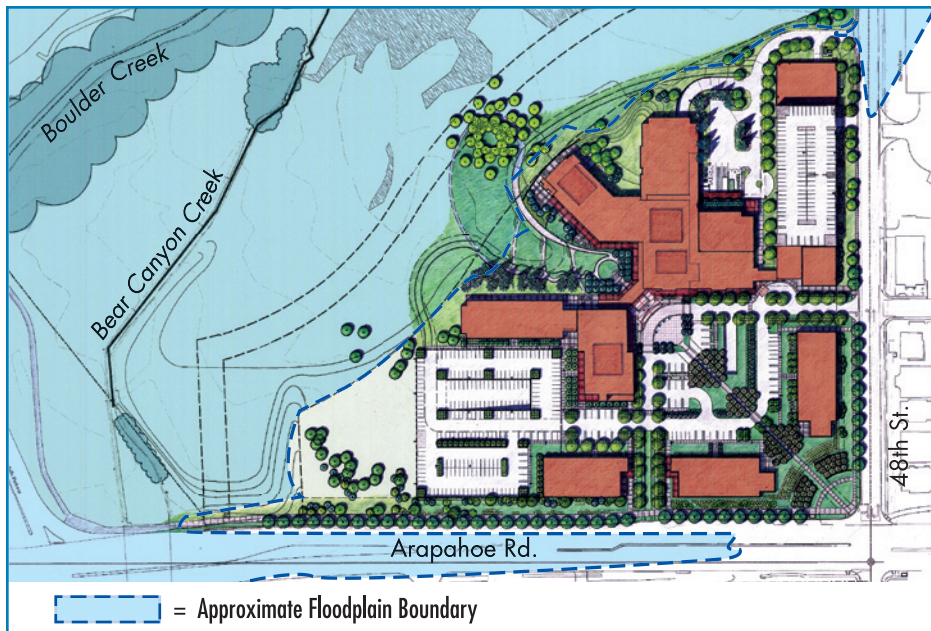

Figure 3-31:
Master site plan of the
Boulder Community
Foothills Hospital,
Boulder, CO.

SOURCE: CIVITAS, INC. AND
OZ ARCHITECTURE

BCFH is licensed for a maximum patient capacity of 54 and has approximately 475 employees, of which about 120 are non-medical. Between the two wings, 220,000 square feet of space is available for patient care (including in-patient rooms, clinics, operating rooms, and the emergency room), and laboratory and administrative uses (including reception, waiting areas, and offices).

In the early planning of the hospital, a search for suitable sites revealed that few vacant parcels of sufficient size (16-17 acres) were available within the city limits. However, a 39-acre parcel in the county was just over the city boundary and could be annexed into the city. The site was entirely within the floodplain of Boulder Creek and a tributary, Bear Canyon Creek, which come together on the property. Two reservoirs are located upstream: Barker Dam on Boulder Creek and Grosse Reservoir on Bear Canyon Creek.

Design of the hospital and the site began while negotiations for the annexation were underway. As part of the conditions of annexation, the city required that the design of the hospital meet the standards of the city's building code and floodplain management ordinance, which include some provisions that are more restrictive than those required by the county. The requirements resulted in several measures intended to provide a higher level of protection against flood hazards than is required for buildings that do not provide critical services.

The 17 acres of the site that were needed for the campus, entirely outside of the designated floodway, were proposed to be filled to an elevation of one-foot above the 100-year flood elevation. The remaining 22 acres were placed in conservation easement. Engineering analyses were performed to demonstrate that no increase in flood elevations would result. The city required approval of a Conditional Letter of Map Revision from FEMA prior to approving the plans. The fill was required to be compacted to 95 percent of the maximum density obtainable with the Standard Proctor Test method. The earthen fill is gently sloped to natural grade and various landscaping elements and retaining walls provide a pleasing transition (Figure 3-32).

Figure 3-32:
Boulder Community Foothills Hospital main entrance, with landscaping and retaining walls for portion of site filled to the 500-year flood elevation (Boulder Creek is behind photographer).



In the BCFH main building, the first floors are used for reception, cafe, ambulatory services, the emergency room, and a six-patient Intensive Care Unit. All patient rooms are on the second and third floors of the three wings, which are built off a single-story connecting reception area. In addition to a separate parking garage structure, some parking is provided in a one-level, below-grade parking garage. The three patient wings have below-grade floors that are used for offices, laundry, laboratories,

materials management, and building service and equipment. To provide natural light, a portion of these below-grade floors are surrounded by a moat (Figure 3-33). Because of anticipated high groundwater and the fact that the below-grade areas are constructed into fill that is subject to saturation during flooding, all below-grade areas are designed and certified as floodproofed spaces. Floodproofing extends 2 feet above the 100-year flood elevation, and 1 foot above the 500-year flood elevation.



Figure 3-33: Below-grade office spaces provide natural light by construction of reinforced moat designed to provide flood protection for a foot above the 500-year flood elevation.

Although the risk of flooding is very low, hospital personnel have identified low points where floodwaters that rise higher than the predicted 500-year flood could begin to affect the facility. The lowest point of entry is the ramp to the parking garage, which is more than a foot higher than the 500-year water surface elevation (Figure 3-34). A supply of sandbags is kept onsite for placement across the ramp. The next most susceptible location is the air handler, although its ground elevation is somewhat higher than the 500-year flood level (Figure 3-35).

Figure 3-34:
Ramp entrance to below-grade parking garage. Note retaining walls on either side; ramp crests at about 16-inches above the 500-year flood elevation.



Figure 3-35:
The upper floors provide patient care. The top of the retaining wall (on right) and the air handler (left of center) are approximately one-foot above the 500-year flood elevation.



The City of Boulder has experienced severe flooding of Boulder Creek on numerous occasions, and is widely known for its efforts to clear portions of the floodplain for use as a greenway and public open space. Prompted by concern about how effectively the city could respond to serious flooding, in early 2006 the city developed a scenario that involved catastrophic flooding, bridge failures, and numerous flooded buildings and neighborhoods. The drill was organized with partners throughout the area, including the Boulder Community Foothills Hospital and other health care facilities.

BCFH, linked to area-wide warnings through NOAA weather radios and the county's emergency management office, had an emergency action

plan, but the participation in the city's flood drill resulted in a number of improvements in communications and protocols for ensuring patient safety.

The original downtown Boulder Community Hospital, built in the 1940s, is partially affected by the 500-year floodplain of Goose Creek. The hospital has implemented measures to reduce flooding. The side of the building that is susceptible to high water from Goose Creek has two doors that are protected by swinging panels permanently mounted in the retaining wall (Figure 3-41). The panels are designed with gaskets to create a seal intended to keep water out when they are deployed. After consideration of the potential for damage and options for protection, a decision was made to leave air-handling equipment at grade in the area that is predicted to flood. The equipment provides extra ventilation for office space, a function that would not be impaired if the equipment was damaged and not functional for a short period of time.

Although not associated with overflow of the creek during wet weather, subsurface drainage off the mountains flows through an abandoned sewer that runs under the building and often overflows through a manhole in the center of a courtyard. To protect the building, sandbags are stockpiled onsite and deployed at the two doors that lead from the courtyard into the building.

3.3.5 DRY FLOODPROOFING CONSIDERATIONS

Dry floodproofing involves a combination of design and special features that are intended both to prevent water infiltration and resist flood forces. According to the NFIP regulations, nonresidential buildings and nonresidential portions of mixed-use buildings in A Zones may be dry floodproofed. Areas used for living and sleeping purposes in health care facilities may not be dry floodproofed because of risks to occupants. Although floodproofing of the nonresidential spaces is allowed, careful consideration must be given to the possible risk to occupants and additional physical damage. Dry floodproofing is not allowed in V Zones.

Dry floodproofing typically involves structural reinforcement so that exterior walls are sufficiently robust to withstand the loads described in Section 3.1.3 (hydrostatic loads, hydrodynamic loads, wave loads, and debris impact loads). Exterior walls must also be designed to prevent infiltration and seepage of water,

Communities that participate in the NFIP require that a registered professional engineer or architect develop or review the structural design, specifications, and plans, and certify that the dry floodproofing design and methods of construction to be used are in accordance with accepted standards of practice. The standards of practice require that the building, together with attendant utility and sanitary facilities, be designed so that it is watertight, with walls substantially impermeable to the passage of water and with structural components having the capability of resisting hydrostatic and hydrodynamic loads and effects of buoyancy associated with the design flood event.

whether through the wall or the openings, including the places where utility lines penetrate the envelope. Floodproofed buildings constructed on permeable soils require additional design attention, because they are also susceptible to hydrostatic pressure from below (buoyancy). An alternative to reinforcement of the structure's walls involves the installation of a permanent floodwall that is slightly offset from the exterior of the structure, but designed to be integral to the foundation.

All flood protection measures are designed for certain flood conditions. Considering the possibility that the design conditions can be exceeded

Although dry floodproofing of facilities in Coastal A Zones is allowed by the NFIP, designs that comply with the IBC must take into consideration the additional forces associated with wave impacts, which may make dry floodproofing a less feasible alternative.

(i.e., water can rise higher than the protective structures) a dry floodproofed building may, in such circumstances, sustain catastrophic damage. As a general rule, dry floodproofing is a poor choice for new hospitals when avoidance of the floodplain or elevation methods to raise the building above the flood level can be applied. Floodproofing may be acceptable for retrofitting existing buildings under certain circumstances (see Section 3.4.5).

A number of dry floodproofing limitations and requirements are specified in ASCE 24:

- Dry floodproofing is limited to areas where flood velocities at the site are less than or equal to 5 feet per second.
- If human intervention is required to deploy measures to protect doors and windows, the flood warning time shall be a minimum of 12 hours unless the community operates a flood warning system and implements a notification procedure that provides sufficient time to undertake these measures.
- At least one door satisfying building code requirements for an exit door or primary means of escape must be provided above the level of protection.
- An emergency plan, approved by the community and posted in at least two conspicuous locations, is required in floodproofed buildings; the plan is intended to specify the location of panels and hardware, methods of installation, conditions that activate deployment, a schedule for routine maintenance of any aspect that may deteriorate over time, and periodic practices and drills.

Windows and doors that are below the flood level used for dry floodproofing design present significant potential failure points. They must be

specially designed units (see Figure 3-36) or be fitted with gasketed, mountable panels that are designed for the anticipated flood conditions and loads. Generally speaking, it is difficult to protect window and door openings from water more than a few feet deep. The framing and connections must be specifically designed for these protective measures, or water pressure may cause window and door frames to separate from the building.

Dry floodproofing is required to extend to 1 or 2 feet above the DFE (see Table 3-1). For the purpose of obtaining NFIP flood insurance, the floodproofing must extend at least 1 foot above the BFE, or the premiums will be very high. A higher level of protection is recommended.

The following documents provide additional information about floodproofing: *Flood Resistant Design and Construction* (ASCE 24-05), *Flood Proofing: How to Evaluate Your Options* (USACE, 1993), *Flood Proofing Regulations* (USACE, 1995), *Floodproofing Non-Residential Structures* (FEMA 102), *Non-Residential Floodproofing – Requirements and Certification* (FIA-TB-3), *Flood Proofing Systems & Techniques* (USACE, 1984).



Figure 3-36: Permanent watertight doors designed for deep water

SOURCE: PRESRAY CORPORATION

Floodproofing techniques are considered to be permanent measures if they are always in place and do not require any specific human intervening action to be effective. Use of contingent floodproofing measures that require installation or activation, such as window shields or inflatable barriers, may significantly reduce the certainty that floodproofing will be effective. Rigorous adherence to a periodic maintenance plan is critical to ensure proper functioning. The facility must have a formal, written plan, and the people responsible for implementing the measures must be informed and trained. These measures also depend on the time-

liness and credibility of the warning. In addition, floodproofing devices often rely on flexible seals that require periodic maintenance and that, over time, may deteriorate and become ineffective. Therefore, a maintenance plan must be developed and a rigorous annual inspection and training must be conducted.

Safety of occupants is a significant concern with dry floodproofed buildings, because failure or overtopping of the floodproofing barriers is likely

Dry floodproofed hospitals must not be considered completely safe for occupancy during periods of high water; floodproofing measures are intended only to reduce physical damage.

to cause catastrophic structural damage. When human intervention is required for deploying of barriers, those responsible for implementing the measures remain at risk, even if a credible warning system is in place, because of the many uncertainties associated with predicting the onset of flood conditions.

3.3.6 FLOOD-RESISTANT MATERIALS

All structural materials, nonstructural materials, and connectors that are used below certain elevations (see Table 3-1) are to be flood-resistant. Flood-resistant materials have sufficient strength, rigidity, and durability to adequately resist flood loads and damage due to saturation. They are building materials that are capable of withstanding direct and prolonged contact with floodwaters without sustaining any damage that requires more than cosmetic repair. As defined in ASCE 24, the term “prolonged contact” means partial or total inundation by floodwaters for 72 hours for non-coastal areas (fresh water) or 12 hours for coastal areas.

FEMA NFIP Technical Bulletin FIA-TB-2, *Flood-Resistant Materials Requirements*, provides some additional information. Many types of materials and application products are classified by degrees of resistance to flood damage.

In general, materials that are exposed to floodwaters are to be capable of resisting damage, deterioration, corrosion, or decay. Typical construction materials range from highly resistant to not at all resistant to water damage. FEMA NFIP Technical Bulletin FIA-TB-2 contains tables with building materials, classified based on flood resistance (Table 3-2).

Table 3-2: Classes of Flood-Resistant Materials

NFIP	Class	Class Description
Acceptable	5	Highly resistant to floodwater damage. Materials in this class are permitted for partially enclosed or outside uses with essentially unmitigated flood exposure.
	4	Resistant to floodwater damage. Materials in this class may be exposed to and/or submerged in floodwaters in interior spaces and do not require special waterproofing protection.
Unacceptable	3	Resistant to clean water damage. Materials in this class may be submerged in clean water during periods of intentional flooding.
	2	Not resistant to water damage. Materials in this class require essentially dry spaces that may be subject to water vapor and slight seepage.
	1	Not resistant to water damage. Materials in this class require dry conditions.

SOURCE: FROM U.S. ARMY CORPS OF ENGINEERS, *FLOODPROOFING REGULATIONS* (1995).

In coastal areas, airborne salt aerosols and inundation with saline water increase the potential for corrosion of some metals. Structural steel and other metal components that are exposed to corrosive environments should be stainless steel or hot-dipped galvanized after fabrication.

In areas away from the coast, exposed structural steel should be primed, coated, plated, or otherwise protected against corrosion. Secondary components such as angles, bars, straps, and anchoring devices, as well as other metal components (plates, connectors, screws, bolts, nails angles, bars, straps, and the like) should be stainless steel or hot-dipped galvanized after fabrication.

Concrete and masonry that are designed and constructed in compliance with applicable standards are generally considered to be flood-resistant. However, masonry facings are undesirable finishes unless extra anchoring is added to prevent separation (see Figure 3-37). Wood and timber members exposed to floodwaters should be naturally decay-resistant species, or pressure treated with appropriate preservatives.

Figure 3-37:
Brick facing separated from masonry wall
(Hurricane Katrina, 2005).



3.3.7 ACCESS ROADS

Roads and entrances leading to hospitals should be designed to provide safe access at all times, to minimize impacts on flood hazard areas, to minimize damage to the road itself, and to minimize exposing vehicles to dangerous situations. Even if the hospital is elevated and protected from flood damage, when access is impaired, functionality is also impaired. Planners and designers should take the following factors into consideration.

Safety factors: Although a hospital's access road off the primary surface street may not be required to carry regular traffic like other streets, a flood-prone road always presents a degree of risk to public safety. To minimize those risks, some State or local regulatory authorities require that access roads be designed so that the driving surface is at the DFE, or no more than 1 to 2 feet below the DFE. At a minimum, a hospital's access road should be at least as high as the adjacent public road, so that the same level of access is provided during conditions of flooding. To maximize evacuation safety, two separate access roads to different feeder roads are recommended. In some circumstances, especially long-duration flooding where a hospital is built on fill, access roads designed to be above flood levels would help the hospital to continue its operations.

Floodplain impacts: Engineering analyses may be required to determine the effects on flood elevations and flow patterns if large volumes of fill are required to elevate a road to minimize or eliminate flooding above the driving surface.

Drainage structure and road surface design: The placement of multiple drainage culverts, even if not needed for local drainage, can facilitate the passage of floodwaters and minimize the potential for a road embankment to act as a dam. Alternatively, an access road can be designed with a low section over which high water can flow without causing damage. Embankments should be designed to remain stable during high water and as waters recede. They should be sloped and protected to resist erosion and scour. Similarly, the surface and shoulders of roads that are intended to flood should be designed to resist erosion. The increased resistance to erosion may be accomplished by increasing the thickness of the road base.

3.3.8 UTILITY INSTALLATIONS

Utilities associated with new hospitals in flood hazard areas must be protected either by elevation or special designs and installation measures. Utilities subject to this provision include all systems, equipment, and fixtures, including mechanical, electrical, plumbing, heating, ventilating, and air conditioning. Potable water systems (wellheads and distribution lines) and wastewater collection lines are addressed in Section 3.3.9.

Utility systems and equipment are best protected when elevated above the DFE (plus freeboard, if required). Equipment that is required for emergency functioning during or immediately after an event, such as emergency generators and fuel tanks, is best installed well above the DFE. In some cases, equipment can be located inside protective floodproofed enclosures, although it must be recognized that if flooding exceeded the design level of the enclosure, the equipment would be adversely affected (see Figure 3-38). Designers should pay particular attention to underfloor utilities and ductwork to ensure that they are properly elevated. Plumbing conduits, water supply lines, gas lines, and electric cables that must extend below the DFE should be located, anchored, and protected to resist the effects of flooding. Equipment that is outside of elevated building also must be elevated:

For more information on utility installations, see *Protecting Building Utilities from Flood Damage: Principles and Practices for the Design and Construction of Resistant Building Utility Systems* (FEMA 348).

- In A Zones, equipment may be affixed to raised support structures or mounted on platforms that are attached to or cantilevered from the primary structure.

- In V Zones and Coastal A Zones, equipment may be affixed to raised support structures designed for the flood conditions (waves, debris impact, erosion, and scour) or mounted on platforms that are attached to or cantilevered from the primary structure. If an enclosure is constructed under the elevated building, the designer must take care that utilities and attendant equipment are not mounted on or do not pass through walls that are intended to break away.

Although it is difficult to achieve, the model building codes and NFIP regulations provide an alternative that allows equipment to be located below the DFE. This alternative requires that such equipment be designed, constructed, and installed to prevent floodwaters from entering or accumulating within the components during flood events.

Figure 3-38:
Equipment room with
watertight door

SOURCE: PRESRAY
CORPORATION



3.3.9 POTABLE WATER AND WASTEWATER SYSTEMS

New installations of potable water systems and wastewater collection systems are required to resist flood damage, including damage associated with infiltration of floodwaters and discharge of effluent. Health concerns arise when water supply systems are exposed to floodwaters. Contamination from flooded sewage systems poses additional health and environmental risks. Onsite water supply wellheads should be located on land elevated from the surrounding landscape to allow contaminated surface water and runoff to drain away. Well casings should extend above the DFE, and casings should be sealed with a tight-fitting, floodproof, and vermin-proof well cap. The space between the well casing and the side of the well must be sealed to minimize infiltration and contamination by surface waters.

Sewer collection lines should be located and designed to avoid infiltration and backup due to rising floodwaters. Devices designed to prevent backup are available and are recommended to provide an added measure of protection.

Onsite sewage systems usually are not used as the primary sewage disposal systems for new hospitals. However, owners, planners and designers should consider a backup onsite system if a facility's functionality can be impaired when the public system is affected by flooding. Local or State health departments may impose constraints that limit or prevent locating septic fields in floodplain soils or within a mapped flood hazard area. If allowed, septic fields should be located on the highest available ground to minimize inundation and damage by floodwaters. An alternative to a septic field is installation of a holding tank that is sized to contain wastewater for a period of time, perhaps a few days, when the municipal system is out of service.

3.3.10 STORAGE TANK INSTALLATIONS

Aboveground and underground storage tanks located in flood hazard areas must be designed to resist flotation, collapse, and lateral movement. ASCE 24 specifies that aboveground tanks be elevated or constructed, installed, and anchored to resist at least 1.5 times the potential buoyant and other flood forces under design flood conditions, assuming the tanks are empty. Similarly, underground tanks are to be anchored to resist at least 1.5 times the potential buoyant forces under design flood conditions, assuming the tanks are empty. In all cases, designers are cautioned to address hydrodynamic loads and debris impact loads that may affect tanks

that are exposed to floodwaters. Vents and fill openings or cleanouts should be elevated above the DFE or designed to prevent the inflow of floodwaters or outflow of the contents of tanks.

3.3.1 1 ACCESSORY STRUCTURES

Depending on the type of accessory structures, full compliance with floodplain management regulations is appropriate and may be required. For example, mechanical buildings, storage buildings, and buildings used for ancillary purposes, such as medical offices and therapy clinics, are not considered to be accessory in nature and must be elevated and protected to the same standards as other buildings.

Some minor accessory structures need not fully comply, but may be “wet floodproofed” using techniques that allow them to flood while minimizing damage. Accessory structures must be anchored to resist flotation, collapse, and lateral movement. Flood-resistant materials must be used and utilities must be elevated above the DFE (plus freeboard, if required). In A Zone flood hazard areas, openings in walls must be provided to allow the free inflow and outflow of floodwaters to minimize the hydrostatic loads that can cause structural damage. Because wet floodproofed accessory buildings are designed to flood, hospital staff must be aware that contents will be damaged.

3.4 RISK REDUCTION FOR EXISTING HOSPITALS

3.4.1 INTRODUCTION

Section 3.2 describes the type of damage that can be sustained by hospitals that already are located in flood hazard areas. The vulnerability of these facilities can be reduced, if they can be made more resistant to flood damage. Decisionmakers may take such action when flood hazards are identified and there is a desire to undertake risk reduction measures proactively. Interest may be prompted by a flood or by the requirement to address flood resistance as part of proposed substantial improvement or an addition. Some questions and guidance intended to help identify building characteristics of importance when considering risk reduction measures for existing facilities are included in the checklist in Section 3.6.

Work on existing buildings and sites is subject to codes and regulations, and the appropriate regulatory authority with jurisdiction should be consulted. With respect to reducing flood risks, work generally falls into the categories described in the following subsections.

3.4.2 SITE MODIFICATIONS

Modifying the site of an existing facility that is subject to flooding requires careful examination by an experienced professional engineer. Determining the suitability of a specific measure requires a complex evaluation of many factors, including the nature of flooding and the nature of the site. The first part of Table 3-3 in Section 3.5 identifies elements that influ-

Owners and operators of public and not-for-profit hospitals should be aware of the importance of flood insurance coverage for facilities that are located in the flood hazard areas shown on NFIP maps. If not insured for flood peril, the amount of flood insurance that should have been in place will be deducted from any Federal disaster assistance payment that would otherwise have been made available. A particular facility may have to absorb up to \$1 million in un-reimbursable flood losses per building, because the NFIP offers \$500,000 in building coverage and \$500,000 in contents coverage for nonresidential buildings (coverage limits as of early 2006).

ence the choice of mitigation measures applicable to existing sites. Some flood characteristics may make it infeasible to apply site modification measures to existing facilities (e.g., depths greater than 3 to 4 feet, very high velocities, insufficient warning because of flash flooding or rapid rate of rise, and very long duration). In Coastal A Zones, wave conditions must be accounted for in design of site modifications. Such modifications are not allowed in V Zones.

A common problem with all site modifications is the matter of access. Depending on the topography of the site, construction of barriers to floodwaters may require special access points. Access points may be protected with manually installed stop-logs or designed gates that drop in, slide, or float into place. Whether activated by automatic systems or manually operated, access protection requires sufficient warning time.

Other significant constraining factors include poor soils and insufficient land area, which can make site modifications either infeasible or very costly. For any type of barrier, rainfall that collects on the dry side must be accounted for in the design, whether through adequately sized stormwater storage basins set aside for this purpose, or by providing large-capacity pumps to move collected drainage to the water side of the barrier.

Each of these site modification measures described below has limitations, including the fact that floods larger than the design flood will exceed the level of protection.

Regrading the site (berm): Regrading of the site, or the construction of an earthen berm, may provide adequate protection for situations in which a facility is exposed to relatively shallow flooding, and sufficient land area is available.

Earthen levee: Earthen levees are engineered structures that are designed to keep water away from certain areas and buildings. Hydraulic analyses and geotechnical investigations are required to determine their feasibility and effectiveness. The use of earthen levees to protect existing facilities is constrained by the availability of land (levees have a large “footprint” and require large land areas), cost (including availability of suitable fill material and long-term maintenance), and access difficulties. Locating levees and floodwalls within a designated floodway is generally not allowed. Rapid onset flooding makes it impractical to design a flood levee with access points that require installation of a closure system. Additionally, high velocity flows can cause erosion and reduce the stability of earthen levees.

Permanent floodwall: Floodwalls are freestanding, permanent engineered structures designed to prevent encroachment of floodwaters. Typically, a floodwall is located some distance from a building, so that structural

modification of the existing building is not required. Depending on the topography of the site, floodwalls may protect only the low side (in which case they must “tie” into high ground) or completely surround a site (which may affect access because special closure structures are required and must be installed before the onset of flooding, see Figure 3-39).



Figure 3-39: A masonry floodwall with multiple engineered openings in Fargo, ND during flooding in 2001.

SOURCE: FLOOD CENTRAL AMERICA, LLC

Mobilized floodwall: This category of flood protection measures includes fully engineered flood protection structures that have permanent features (foundation and vertical supports) and features that require human intervention when a flood is predicted (horizontal components called planks or stop-logs). Mobilized floodwalls have been used to protect entire sites, or to tie into permanent floodwalls or high ground. Because of the manpower and time required for proper placement, these measures are better suited to conditions that allow long warning times.

3.4.3 ADDITIONS

Model building codes generally treat additions as new construction, and require hospital additions in flood hazard areas to be elevated or dry floodproofed to minimize exposure to flooding. However, full compliance with the code and NFIP requirements is only required if an addition is a substantial improvement (i.e., the cost of the addition plus all other costs associated with the work equal or exceed 50 percent of the market value of the building, see Section 3.1.6.1 and Section

For more information on additions and substantial improvements, see *Answers to Questions About Substantially Damaged Buildings* (FEMA 213).

3.1.6.2). Designers are cautioned that even the existing buildings may be required to comply with the flood-resistant provisions of the code or local ordinances, if the addition is structurally connected to the existing building and is determined to be a substantial improvement.

Section 3.3.4 outlines foundation methods used to elevate buildings that also are applicable to additions. Elevation of an addition on fill may not be feasible unless structural fill can be placed adjacent to the existing building. Utility service equipment for additions must meet the requirements for new installations (see Section 3.3.7).

If an evaluation determines that dry floodproofing is appropriate, additions may be floodproofed (see Section 3.3.5). To provide adequate protection for the addition, floodproofing must be applied to all exterior walls and the wall adjoining the existing building. Openings, including doors between the addition and existing building, must also be protected.

With respect to code compliance and designing additions to resist flood damage, one of the more significant issues to be considered is ease of access. If the lowest floor of the existing facility is below the DFE, steps, ramps, or elevators will be required for the transition to the new addition (See Figure 3-40). Some jurisdictions may contemplate allowing variances to the requirement for elevation, because alternative means of access are available, such as ramps and elevators. Under the regulations of the NFIP and FEMA guidance, it is not considered appropriate to grant such a variance.

Figure 3-40:
Tampa General Hospital solved the problem of access to the new elevated Emergency Department by designing a vehicle ramp. Visitors and ambulatory patients take elevators from the ground floor.

SOURCE: TAMPA GENERAL HOSPITAL



3.4.4 REPAIRS, RENOVATIONS, AND UPGRADES

Every hospital considered for upgrades and renovations, or being repaired after substantial damage from any cause, must be examined for structural integrity and stability to determine compatibility with structural modifications that may be required to achieve acceptable performance. When an existing facility is located in a flood hazard area, that examination should include consideration of measures to improve resistance to flood damage and to reduce risks.

The model building codes and the regulations of the NFIP require that work constituting “substantial improvement” of an existing building be in compliance with the flood-resistant provisions of the code. Non-substantial improvements should take into account measures to reduce future flood damage, such as those described in Section 3.3, emergency measures (see Section 3.4.9), and wet floodproofing measures that allow water to enter the building to avoid structural damage.

Compliance with flood-resistant provisions means that the existing building must be elevated or dry floodproofed. Both options can be difficult for existing hospitals, given the typical use, size, and complexity of some of these buildings. Retrofit dry floodproofing (described in Section 3.4.5) is generally limited to water depths of 3 feet or less, provided an assessment by a qualified design professional determines that the building is capable of resisting the anticipated loads, or can be modified to provide that level of performance.

Elevating an existing building presents an entirely different set of challenges and also requires detailed structural engineering analyses. It involves the same equipment and methods used to move other types of buildings; expert building movers have successfully moved large, heavy, and complex buildings, sometimes by segmenting them. A building that is elevated in-place must meet the same performance standards set for new construction.

Additional information on rehabilitation of existing buildings is provided in: *Flood Proofing: How to Evaluate Your Options* (USACE, 1993), *Floodproofing Non-Residential Structures* (FEMA 102), *Floodproofing—Requirements and Certification* (FIA-TB-3), and *Engineering Principles and Practices for Retrofitting Flood-prone Buildings* (FEMA 259). Although written primarily for homes, this last reference contains very detailed checklists and worksheets that can be modified. They also provide some guidance for evaluating the costs and benefits of various measures.

3.4.5 RETROFIT DRY FLOODPROOFING

Modification of an existing building may be required or desired in order to address exposure to design flood conditions. Modifications that may be considered include construction of a reinforced supplementary wall, measures to counter buoyancy (especially if there is below-grade space), installation of special watertight door and window barriers (see Figure 3-41), and providing watertight seals around the points of entry of utility lines. The details of structural investigations and structural design of such protection measures are beyond the scope of this manual.

Because of the tremendous flood loads that may be exerted on a building not originally designed to keep water out, detailed structural engineering evaluations are required to determine whether an existing building can be dry floodproofed. The following elements must be examined:

“Dry floodproofing” refers to measures and methods to render a building envelope substantially impermeable to floodwater.

- The strength of the structural system
- Whether non-load bearing walls can resist anticipated flood loads; secondary walls can be constructed immediately adjacent to existing walls, with a waterproof membrane, to provide adequate strength
- The effects of hydrostatic pressures on the walls and floors of below-grade areas
- Effective means to install watertight doors and windows, or mountable panels
- Protection where utilities enter the building
- Methods to address seepage, especially where long-duration flooding is anticipated
- Whether there is sufficient time for deployment of measures that require human intervention, given the availability of official warnings of predicted flood conditions

Application of waterproofing products or membranes directly to exterior walls may minimize infiltration of water; although there are concerns with durability and limitations on use (this measure is most effective for shallow, short-duration flooding). Some protection can be achieved using emergency measures that are not designed to be integral to the building (see Section 3.4.9).



Figure 3-41: Boulder Community Hospital, Boulder, CO, installed this permanently mounted floodgate in a low floodwall; the floodgate swings to the left to keep water away from the mechanical equipment room.

3.4.5.1 The Case of Pungo District Hospital, Belhaven, North Carolina

The Pungo District Hospital has served the waterfront town of Belhaven, North Carolina, and the surrounding area for nearly 60 years (Figure 3-42). The facility is only about 100 feet back from the waters of a canal and Pantego Creek, a tidal tributary to the Pungo River in Beaufort County. As with the rest of coastal North Carolina, Beaufort County has seen more than its share of hurricanes. Notable named storms that affected the area in just the past decade include Hurricanes Fran (1996), Dennis (1999), Floyd (1999), and Isabel (2003).



Figure 3-42: Pungo District Hospital is situated adjacent to a canal and Pantego Creek, a tidal tributary to the Pungo River in eastern North Carolina.

With about 20,000 residents in its service area, Pungo District Hospital offers 49 beds for acute care, transitional care, intensive care, and ventilation care services. Outpatient clinics and programs include a cardiology clinic, nephrology clinic, pulmonary clinic, EKG/EEG, home health, sleep apnea program, speech therapy, laboratory medicine, imaging services, cardio-pulmonary services, nutritional counseling, and patient education. The 175 employees (full- and part-time) include 108 medical and 67 non-medical staff. The facility encompasses a total of 57,000 square feet, of which 84 percent is used for patient care and the remainder is used for administrative and other support services.

The original one-story hospital building was built on piers in 1949, in the traditional crawlspace style that typifies older buildings in areas with high groundwater and humid conditions. A number of one-story additions were constructed in the 1960s and 1970s. The most recent work, started in 1997, consisted of two additions that expanded the facility and renovation of a large portion of the hospital. With the exception of the mechanical room, the additions were built to match the original floor elevation using masonry block stemwall foundations (perimeter walls with slab-on-structural fill). The floor of the mechanical room is approximately 18-inches lower than the main floor elevation, but does not extend below-grade.

The Town of Belhaven has participated in the NFIP since the mid-1970s, administering an ordinance that requires new buildings and substantially improved buildings to comply with certain requirements to reduce exposure to flood hazards. The predicted BFE along the waterfront is 8-feet above mean sea level. Worst-case hurricane surge flooding is likely to rise even higher. Observations in the past decade indicate that flooding may last from 12 to 18 hours, largely as a function of the path of a hurricane and tidal cycle.

The ground elevation around the hospital is about 4.5-feet above mean sea level, indicating the site would experience 3.5-feet of flooding during the base flood. The floor of the main building is nearly 2.5-feet above-grade; thus, the 100-year flood would reach a level approximately 1-foot above the floor. Because the floor of the mechanical room is lower than in the main building, the 100-year flood would flood the room with about 3-feet of water.

In 1997, the City of Belhaven determined that the proposed expansions and other work in the main building would be a substantial improvement (the cost of the proposed work exceeded 50 percent of the market value of the building). This determination triggered compliance with the city's building code and floodplain management ordinance. Two alternatives were available to bring the building into compliance: elevating the existing building and additions nearly 18 inches (so the floor level would

be at the flood level) or retrofitting the building by dry floodproofing. To address this requirement, the hospital hired an engineering company to examine the existing building and the proposed new addition, and to design appropriate floodproofing measures.

The engineer's examination determined that the exterior walls of the existing building were sufficiently strong to resist the flood loads anticipated during the 100-year flood conditions, provided the entrances and other openings through the exterior wall were sealed to prevent entry of water. The dry floodproofing measures proposed entailed construction of low concrete walls in certain areas and installation of specially fabricated frames and metal panels for some doors, floodwall openings, and crawlspace ventilation openings (Figures 3-43 and 3-44). The top of the concrete wall and the tops of the panels were set about 2 feet higher than the BFE, providing 2 feet of freeboard as a factor of safety. To provide additional protection to the new addition, a rubber membrane was installed between the brick facing and the block wall. The total cost of the floodproofing measures was \$125,000 (1997 dollars).



Figure 3-43:

A special floodproofing panel is manually installed in this concrete floodwall to keep floodwater away from the rear courtyard and patient rooms.

Figure 3-44:
The ventilation openings for the original building's crawlspace are protected with floodproofing panels that are bolted in place when flooding is predicted.



The frames that hold the floodproofing panels are permanently-mounted and sealed against the building to prevent seepage. The frames are designed with an aluminum cover to keep the channels free of dirt and debris. The metal panels that fit into the channels have rubber gaskets that are inspected each year as part of the hospital's routine maintenance program. The manufacturer recently advised replacement of the gaskets, as the 10-year anniversary of installation nears.

A total of 15 panels of different sizes are stored onsite (Figure 3-45). Although the panels can be handled by two people (Figure 3-46), the hospital has an on-call agreement with a local rental company to use a forklift to facilitate moving them into place. All panels can be installed in about 3 hours.

Pungo District Hospital fully recognizes its vulnerability to coastal storms and the importance of protecting its patients as well as providing services after a major event. The facilities services director monitors weather throughout the hurricane season, coordinating with the county emergency services and town officials responsible for issuing evacuation notices.



Figure 3-45:
Large floodproofing panels are stored at the hospital, ready for installation when coastal flooding is predicted.



Figure 3-46:
Most of the panels can be installed by hand. Note the protective metal strip leaning against the building on the left; normally this strip covers the horizontal channel into which the panel is inserted.

The detailed evacuation plan was triggered as Hurricane Isabel approached in September 2003. In less than 4 hours all patients, staff, and supplies were relocated safely to the Beaufort Memorial Hospital, about 30 miles inland. Total shutdown of the building, including installation of the floodproofing panels, took about 12 hours. An emergency generator, located inside the protected area, was activated in order to run four sump pumps to handle groundwater that seeps into the crawlspace

of the original building. Isabel's storm surge produced the highest flooding on record in Belhaven, yet the hospital weathered the storm without damage.

Reoccupation of the hospital began when the town cleared the streets and all systems of the building were brought back online. Municipal water and sewer services were not interrupted by flooding.

Despite decades of weathering hurricanes, the Pungo District Hospital has not sustained major wind damage. The absence of trees or other buildings between the hospital and the water prevents major wind-borne debris damage. Water-borne debris is deposited around the facility every time high water crests the bulkhead that lines creek. One corner of the parking lot, which extends nearly to the bulkhead, sustained damage as Hurricane Isabel's rising water lifted and displaced the asphalt (Figure 3-47).

Figure 3-47:

High water and waves eroded the slope between the parking lot and the bulkhead and shifted a portion of the asphalt.



3.4.6 UTILITY INSTALLATIONS

Some features of utility systems in existing hospitals prone to flooding may need to be modified to reduce damage. The effectiveness of such measures depends not only on the nature of the flooding, but the type of service and the degree of exposure. Table 3-3 in Section 3.5 lists some questions to help facility planners and designers examine risk reduction measures.

Even if a facility is unlikely to sustain extensive structural damage from flooding, significant recovery costs and interruption of operations may result if utility systems are damaged. The damage reduction measures described below can be applied, whether undertaken as part of large-scale retrofits of existing buildings or as separate projects.

Relocate from below-grade areas: The most vulnerable utility installations are those located below grade, and the most effective protection measure is to relocate them to higher floors or platforms that are at least 2 feet above the DFE. The complexity of rerouting pipes, conduits, ductwork, electrical service, lines, and connections will depend on building- and site-specific factors.

Additional guidance on improving the flood resistance of utility installations in existing buildings is found in FEMA 348, *Protecting Building Utilities From Flood Damage: Principles and Practices for the Design and Construction of Flood Resistant Building Utility Systems*.

Elevate components: Whether located inside or outside of the building, some components of utility systems can be elevated-in-place on platforms, including electric transformers, communication switch boxes, water heaters, air-conditioning compressors, generators, furnaces, boilers, and heat pumps (see Figure 3-48).



Figure 3-48:
Elevated utility box

Anchor tanks and raise openings: Existing tanks can be elevated or anchored, as described in Section 3.4.10. If anchored below the DFE, tank inlets, vents, fill pipes, and openings should be elevated above the DFE, or fitted with covers designed to prevent the inflow of floodwaters or outflow of the tank's contents.

Protect components: If utility components cannot be elevated, it may be feasible to construct watertight enclosures, or enclosures with watertight seals that require human intervention to install when flooding is predicted.

Elevate control equipment: Control panels, gas meters, and electrical panels can be elevated, even if the equipment they service cannot be protected.

Separate electrical controls: Where areas within an existing facility are flood-prone, separation of control panels and electrical feeders will facilitate shutdown before floodwaters arrive, and help protect workers during cleanup.

Protect against electrical surges: Current fluctuations and service interruptions are common in areas affected by flooding. Equipment and sensitive electrical components can be protected by installing surge protection and uninterruptible power supplies.

Connections for portable generators: Prewired portable generator connections allow for quick, failure-free connection and disconnection of the generators when needed for continued functionality.

3.4.7 POTABLE WATER AND WASTEWATER SYSTEMS

All plumbing fixtures connected to the potable water system may become weak points in the system if they allow floodwaters to contaminate the system. Relocating the fixtures and services that require plumbing to elevated floors and removing the fixtures that are below the DFE provides protection. Wellheads can be sealed with watertight casings or protected within sealed enclosures.

Wastewater system components become sources of contamination during floods. Rising floodwaters may force untreated sewage to backup through toilets. Specially designed devices that prevent back-flow can be installed, or restrooms below the DFE can be provided with overhead piping that may require specially designed pumps to operate properly. Septic tanks can be sealed and anchored.

3.4.8 OTHER DAMAGE REDUCTION MEASURES

A number of steps can be taken to make existing facilities in flood hazard areas more resistant to flood damage, which also facilitates rapid recovery, cleanup, and timely return to normalcy. Whether these measures are applicable to a specific facility depends, in part, on the characteristics of the flood hazard and the characteristics of the building itself. Facility planners and designers should consider the following:

- Rehabilitate and retrofit the building envelope with openings specifically designed to allow floodwaters to flow in and out to minimize hydrostatic pressure on walls (called wet floodproofing). Although it allows water to enter the building, this measure minimizes the likelihood of major structural damage. Walls that enclose interior spaces would also be retrofitted with openings.
- Replace interior walls that have cavities with flood-resistant construction or removable panels to facilitate cleanup and drying.
- Abandon the use of below-grade areas (basements) and fill them in to prevent structural damage.
- Permanently relocate high-value or sensitive functions that are often found on the ground floor of hospitals (e.g., offices, records, libraries, and computer laboratories) to higher floors or elevated additions.
- Install backflow devices in sewer lines.
- Preplan actions to move high-value contents from the lower floors to higher floors when a flood warning is issued.
- Replace wall, flooring, and finish materials with flood-resistant materials. Concrete floors with a sealed, polished, or terrazzo finish have few maintenance requirements, but tend to be slippery when wet.
- Use epoxy or other impervious paints on concrete and other permeable surfaces to minimize contamination.
- Install separate electric circuits and ground fault interrupter circuit protection in areas that will flood. Emergency measures should be provided so that electrical service can be shut down to avoid electrocution hazards.
- Relocate chemicals to storage areas not subject to flooding.

3.4.9 EMERGENCY MEASURES

Emergency response to flooding is outside the scope of this manual. However, it is appropriate to examine feasible emergency measures that may provide some protection. The following discussion pertains only to emergency measures that have been used to reduce flood damage to older buildings that are already located in flood hazard areas. They may not provide protection to occupants and they can experience a high frequency of failure depending on human factors related to deployment. These measures do not achieve compliance with building and life safety codes for new construction.

Emergency barriers are measures of “last resort,” and should be used only when a credible flood warning with adequate lead-time is available and dependable. These measures have varying degrees of success, depending on the available manpower, skill required, long-term maintenance of materials and equipment, suitability for site-specific flood conditions, and having sufficient advanced warning. Complete evacuation of protected buildings is appropriate, as these measures should not be considered adequate protection for occupants.

Sandbag walls: Unless emergency placement is planned well in advance or under the direction of trained personnel, most sandbag barriers are not constructed in accordance with proper practices, leading to leakage and failures. Because of the intensive work effort and length of time required for protection even from relatively shallow water, sandbag walls are not a reliable protection measure. To be effective, sandbags and sand should be stockpiled and checked regularly to ensure that sandbags have not deteriorated. Sandbags have some other drawbacks, including high disposal costs and their tendency to absorb pollutants from contaminated floodwaters, which necessitates disposal as hazardous waste.

Water-filled barriers: A number of vendors make water-filled barriers that can be assembled with relative ease, depending on the source of water for filling. The barriers must be specifically sized for the site. Training and annual drills are important so that personnel know how to place and deploy the barriers. Proper storage, including cleaning after deployment, is necessary to protect the materials over long periods of time.

Panels for doors: For shallow and short-duration flooding, panels of sturdy material can be made to fit doorways to minimize the entry of floodwaters, although failure is common (see Figure 3-49). Effectiveness is increased significantly if a flexible gasket or sealant is provided, and the mounting hardware is designed to apply even pressure. Personnel must know where the materials are stored and be trained in

their deployment. A number of vendors make special doors for permanent installation and drop-in panels or barriers that are designed to be watertight.



Figure 3-49:
Flooding at Hancock
Medical Center during
Hurricane Katrina

SOURCE: HANCOCK
MEDICAL CENTER

3.5 CHECKLIST FOR BUILDING VULNERABILITY OF FLOOD-PRONE HOSPITALS

The Checklist for Building Vulnerability of Flood-Prone Hospitals (Table 3-3) is a tool that can be used to help assess site-specific flood hazards and building vulnerability. The checklist is useful during site selection, preliminary design of a new building, or when considering rehabilitation of an existing facility. In addition to examining building design issues that affect vulnerability, the checklist also helps users to examine the functionality of the critical and emergency systems upon which most hospitals depend. The checklist is organized into separate sections, so that each section can be assigned to a subject expert for greater accuracy of the examination. The results should be integrated into a master vulnerability assessment to guide the design process and the choice of appropriate mitigation measures.

Table 3-3: Checklist for Building Vulnerability of Flood-Prone Hospitals

Vulnerability Sections	Guidance	Observations
Site Conditions		
<p>Is the site located near a body of water (with or without a mapped flood hazard area)?</p> <p>Is the site in a flood hazard area shown on the community’s map (FIRM or other adopted map)? If so, what is the flood zone?</p> <p>Is the site affected by a regulatory floodway?</p>	<p>All bodies of water are subject to flooding, but not all have been designated as a floodplain on FIRMs.</p> <p>Flood hazard maps usually are available for review in local planning and permit offices. Electronic versions of the FIRMs may be available online at www.fema.gov. Paper maps may be ordered by calling (800) 358-9616.</p> <p>Development in floodways, where floodwaters typically are faster and deeper, must be supported by engineering analyses that demonstrate no rise in flood levels</p>	

Table 3-3: Checklist for Building Vulnerability of Flood-Prone Hospitals (continued)

Vulnerability Sections	Guidance	Observations
Site Conditions (continued)		
<p>Is the site located in a storm surge inundation zone (or tsunami inundation area)?</p>	<p>In coastal communities, even sites at some distance inland from the shoreline may be exposed to extreme storm surge flooding. Storm surge maps may be available at State or local emergency management offices.</p>	
<p>What is the DFE (or does an analysis have to be done to determine the DFE)? What is the minimum protection level required by regulatory authorities?</p> <p>Does the FIS or other study have information about the 500-year flood hazard area?</p> <p>Has FEMA issued post-disaster advisory flood elevations and maps?</p> <p>What are the expected depths of flooding at the site (determined using flood elevations and ground elevations)?</p>	<p>Reference the FIS for flood profiles and data tables. Site-specific analyses should be performed by qualified engineers.</p> <p>Check with regulatory authorities to determine the required level of protection.</p> <p>If a major flood event has affected the community, FEMA may have issued new flood hazard information, especially if areas not shown on the FIRMs have been affected. Sometimes these maps are adopted and replace the FIRMs; sometimes the new data are advisory only.</p>	
<p>Has the site been affected by past flood events? What is the flood of record?</p>	<p>Records of actual flooding augment studies that predict flooding, especially if historic events resulted in deeper or more widespread flooding. Information may be available from local planning, emergency management, and public works agencies, or State agencies, the U.S. Army Corps of Engineers, or the Natural Resources Conservation Service.</p> <p>The flood of record is often a lower probability event (with higher flood elevations) than the 100-year flood.</p>	
<p>What is the expected velocity of floodwaters on the site?</p>	<p>Velocity is a factor in computing loads associated with hydrodynamic forces, including drag on building surfaces. Approximations of velocity may be interpolated from data in the FIS Floodway Data Table if the waterway was studied using detailed methods, application of approximation methods based on continuity, local observations and sources, or site-specific studies.</p>	

Table 3-3: Checklist for Building Vulnerability of Flood-Prone Hospitals (continued)

Vulnerability Sections	Guidance	Observations
Site Conditions (continued)		
<p>Are waves expected to affect the site?</p>	<p>Waves can exert considerable dynamic forces on buildings and contribute to erosion and scour. Wind-driven waves occur in areas subject to coastal flooding and where unobstructed winds affect wide floodplains (large lakes and major rivers). Standing waves may occur in riverine floodplains where high velocities are present.</p>	
<p>Is there information on how quickly floodwaters may affect the site?</p> <p>What is the expected duration of flooding?</p>	<p>Warning time is a key factor in the safe and orderly evacuation of critical facilities. Certain protective measures may require adequate warning so that actions can be taken by skilled personnel.</p> <p>Duration has bearing on the stability of earthen fills, access to a site and emergency response, and durability of materials that come into contact with water. Records of actual flooding are the best indicator of duration as most floodplain analyses do not examine duration.</p>	
<p>Is there a history of flood-related debris problems or erosion on the site?</p>	<p>Site design should account for deposition of debris and sediment, as well as the potential for erosion-related movement of the shoreline or waterway. Buildings exposed to debris impact or undermining by scour and erosion should be designed to account for these conditions.</p>	
<p>Is the site within an area predicted to flood if a levee or floodwall fails or is overtopped?</p> <p>Is the site in an area predicted to be inundated if an upstream dam were to fail?</p>	<p>Flood protection works may be distant from sites and not readily observable. Although a low probability event, failure or overtopping can cause unexpected and catastrophic damage because the protected lands are not regulated as flood hazard areas.</p> <p>The effects of an upstream dam failure are not shown on the FIRMs or most flood hazard maps prepared locally. Although dam failure generally is considered an unlikely event, the potential threat should be evaluated due to the catastrophic consequences. (Note: owners of certain dams should have emergency action plans geared toward notification and evacuation of vulnerable populations and critical facilities.)</p>	

Table 3-3: Checklist for Building Vulnerability of Flood-Prone Hospitals (continued)

Vulnerability Sections	Guidance	Observations
Site Conditions (continued)		
<p>Does the surrounding topography contribute to the flooding at the site? Is there a history of local surface drainage problems due to inadequate site drainage?</p>	<p>If areas with poor local drainage and frequent flooding cannot be avoided, filling, regrading, and installation of storm drainage facilities may be required.</p>	
<p>Given the nature of anticipated flooding and soils, is scour around and under the foundation likely?</p>	<p>Scour-prone sites should be avoided, in part due to likely long-term maintenance requirements. Flooding that is high velocity or accompanied by waves is more likely to cause scour, especially on fills, or where local soils are unconsolidated and subject to erosion.</p>	
<p>Has water from other sources entered the building (i.e., high groundwater, water main breaks, sewer backup, etc.)? Is there a history of water intrusion through floor slabs or well-floor connections? Are there underground utility systems or areaways that can contribute to basement flooding? Are there stormwater sewer manholes upslope of window areas or openings that allow local drainage to enter the basement/lower floor areas?</p>	<p>These questions pertain to existing facilities that may be impaired by water from sources other than the primary source of flooding. The entire building envelope, including below-grade areas, should be examined to identify potential water damage.</p>	
<p>Is at least one access road to the site/building passable during flood events?</p> <p>Are at-grade parking lots located in flood-prone areas?</p> <p>Are below-grade parking areas susceptible to flooding?</p>	<p>Access is increasingly important as the duration of flooding increases. For the safety of occupants, most critical facilities should not be occupied during flood events.</p> <p>Areas where vehicles could be affected should have signage to warn users of the risk. Emergency response plans should include notification of car owners.</p>	

Table 3-3: Checklist for Building Vulnerability of Flood-Prone Hospitals (continued)

Vulnerability Sections	Guidance	Observations
Architectural		
<p>Are any critical building functions occupying space that is below the elevation of the 500-year flood or the Design Flood Elevation?</p> <p>Can critical functions be relocated to upper levels that are above predicted flood elevations?</p> <p>If critical functions cannot be relocated, is floodproofing feasible?</p> <p>If critical functions must continue during a flood event, have power, supplies, and access issues been addressed?</p>	<p>New critical facilities built in flood hazard areas should not have any functions occupying flood-prone spaces (other than parking, building access, and limited storage).</p> <p>Existing facilities in floodplains should be examined carefully to identify the best options for protecting functionality and the structure itself.</p>	
<p>Have critical contents (files, computers, servers, equipment, research, and data) been located on levels of the facility above the flood elevations?</p> <p>Are critical records maintained offsite?</p>	<p>For existing facilities that are already located in flood hazard areas, the nature of the facility may require continued use of flood-prone space. However, the potential for flooding should be recognized and steps taken to minimize loss of expensive equipment and irreplaceable data. If critical contents cannot be permanently located on higher floors, a flood response plan should take into account the time and attention needed to move such contents safely.</p>	
Structural Systems		
<p>What is the construction type and the foundation type and what is the load bearing capacity?</p> <p>Has the foundation been designed to resist hydrostatic and hydrodynamic flood loads?</p>	<p>If siting in a floodplain is unavoidable, new facilities are to be designed to account for all loads and load combinations, including flood loads.</p>	
<p>If the building has below-grade areas (basements), are the lower floor slabs subject to cracking and uplift?</p>	<p>Below-grade spaces and their contents are most vulnerable to flooding and local drainage problems. Rapid pump out of below-grade spaces can unbalance forces if the surrounding soil is saturated, leading to structural failure. If below-grade spaces are intended to be dry floodproofed, the design must account for buoyant forces.</p>	

Table 3-3: Checklist for Building Vulnerability of Flood-Prone Hospitals (continued)

Vulnerability Sections	Guidance	Observations
Structural Systems (continued)		
	<p>Building spaces below the design flood level can be dry floodproofed, although it must be recognized that higher flood levels will overtop the protection measures and may result in severe damage. Dry floodproofing creates large unbalanced forces that can jeopardize walls and foundations that are not designed to resist the hydrostatic and hydrodynamic loads.</p>	
<p>Are any portions of the building below the Design Flood Elevation?</p> <p>Has the building been damaged in previous floods?</p>	<p>For existing buildings, it is important to determine which portions are vulnerable in order to evaluate floodproofing options. If flood depths are expected to exceed 2 or 3 feet, dry floodproofing may not be feasible. Alternatives include modifying the use of flood-prone areas.</p>	
<p>If the building is elevated on a crawlspace or on an open foundation, are there any enclosed areas?</p>	<p>New buildings may have enclosures below the flood elevation, provided the use of the enclosures is limited (crawlspace, parking, building access, and limited storage). In addition, the enclosures must have flood openings to automatically allow for inflow and outflow of floodwaters to minimize differential hydrostatic pressure.</p> <p>Existing buildings that are elevated and have enclosures below the flood elevation can be retrofit with flood openings.</p>	
<p>For an existing building with high-value uses below the flood elevation, is the building suitable for elevation-in-place, or can it be relocated to higher ground?</p>	<p>Elevating a building provides better protection than dry floodproofing. Depending on the type and soundness of the foundation, even large buildings can be elevated on a new foundation or moved to a site outside of the floodplain.</p>	
Building Envelope		
<p>Are there existing floodproofing measures in place below the expected flood elevation? What is the nature of these measures and what condition are they in? Is there an annual inspection and maintenance plan?</p> <p>Is there an “action plan” to implement floodproofing measures when flooding is predicted? Do the building operators/occupants know what to do when a flood warning is issued?</p>	<p>Floodproofing measures are only as good as the design and their condition, especially if many years have passed since initial installation. Floodproofing measures that require human intervention are entirely dependent on the adequacy of advance warning, and the availability and ability of personnel to properly install the measures.</p>	

Table 3-3: Checklist for Building Vulnerability of Flood-Prone Hospitals (continued)

Vulnerability Sections	Guidance	Observations
Building Envelope (continued)		
For existing buildings, what types of openings penetrate the building envelope below the 500-year flood elevation or the DFE (doors, windows, cracks, vent openings, plumbing fixtures, floor drains, etc.)?	For dry floodproofing to be effective, every opening must be identified and measures taken to permanently seal or to prepare special barriers to resist infiltration. Sewage backflow can enter through unprotected plumbing fixtures.	
Are flood-resistant materials used for structural and nonstructural components and finishes below the 500-year elevation or the DFE?	Flood-resistant materials are capable of withstanding direct and prolonged contact with floodwaters without sustaining damage that requires more than cosmetic repair. Contact is considered to be prolonged if it is 72 hours or longer in freshwater flooding areas, or 12 hours or longer in areas subject to coastal flooding.	
Utility Systems		
Is the potable water supply for the facility protected from flooding? If served by a well, is the wellhead protected?	Operators of critical facilities that depend on fresh water for continued functionality should learn about the vulnerability of the local water supply system, and the system's plans for recovery of service in the event of a flood.	
Is the wastewater service for the building protected from flooding? Are any manholes below the DFE? Is infiltration of floodwaters into sewer lines a problem? If the site is served by an onsite system that is located in a flood-prone area, have backflow valves been installed?	Most waste lines exit buildings at the lowest elevation. Even buildings that are outside of the floodplain can be affected by sewage backups during floods.	
Are there any aboveground or underground tanks on the site in flood hazard areas? Are they installed and anchored to resist flotation during the design flood? Are tank openings and vents elevated above the 500-year elevation or the DFE, or otherwise protected to prevent entry of floodwater or exit of product during a flood event?	Dislodged tanks become floating debris that pose special hazards during recovery. Lost product causes environmental damage. Functionality may be impaired if tanks for heating fuel, propane, or fuel for emergency generators are lost or damaged.	

Table 3-3: Checklist for Building Vulnerability of Flood-Prone Hospitals (continued)

Vulnerability Sections	Guidance	Observations
Mechanical Systems		
<p>Are air handlers, HVAC systems, ductwork, and other mechanical equipment and systems located above the 500-year elevation or the DFE? Are the vents and inlets located above flood level, or sealed to prevent entry of floodwater?</p>	<p>In existing buildings, utility equipment that is critical for functionality should be relocated to higher floors or into elevated additions.</p>	
Plumbing and Gas Systems		
<p>Are plumbing fixtures and gas-fired equipment (meters, pilot light devices/burners, etc.) located above the 500-year elevation or the DFE?</p>	<p>In existing buildings, utility equipment that is critical for functionality should be relocated to higher floors or into elevated additions.</p>	
<p>Is plumbing and gas piping that extends below flood levels installed to minimize damage?</p>	<p>Piping that is exposed could be impacted by debris.</p>	
Electrical Systems		
<p>Are electrical systems, including backup power generators, panels, and primary service equipment, located above the 500-year elevation or the DFE?</p> <p>Are pieces of electrical stand-by equipment and generators equipped with circuits to turn off power?</p> <p>Are the switches and wiring required for safety (minimal lighting, door openers) located below the flood level designed for use in damp locations?</p>	<p>In existing buildings, utility equipment that is critical for functionality should be relocated to higher floors or into elevated additions.</p>	
Fire Alarm Systems		
<p>Is the fire alarm system located above the 500-year elevation or the DFE?</p>	<p>In existing buildings, utility equipment that is critical for functionality should be relocated to higher floors or into elevated additions.</p>	
Communications and IT Systems		
<p>Are the communication/IT systems located above the 500-year elevation or the DFE?</p>		

3.6 REFERENCES AND SOURCES OF ADDITIONAL INFORMATION

Note: FEMA publications may be obtained at no cost by calling (800) 480-2520, faxing a request to (301) 497-6378, or downloading from the library/publications section online at <http://www.fema.gov>.

American Society of Civil Engineers (ASCE), Structural Engineering Institute, 2005a, *Flood Resistant Design and Construction*, ASCE/SEI 24-05, Reston, VA

American Society of Civil Engineers (ASCE), Structural Engineering Institute, 2005b, *Minimum Design Loads for Buildings and Other Structures*, ASCE/SEI 7-05, Reston, VA.

Association of State Floodplain Managers, Inc. (ASFM), 2004, *Floodplain Management 2003: State and Local Programs*, Madison, WI.

Federal Emergency Management Agency (FEMA), 1986, *Floodproofing Non-Residential Structures*, FEMA 102, Washington, DC, May 1986.

Federal Emergency Management Agency (FEMA), 1991, *Answers to Questions about Substantially Damaged Buildings*, FEMA 213, Washington, DC, May 1991.

Federal Emergency Management Agency (FEMA), 1995, *Engineering Principles and Practices for Retrofitting Flood-prone Residential Buildings*, FEMA 259, Washington, DC, January 1995.

Federal Emergency Management Agency (FEMA), 1999, *Protecting Building Utilities From Flood Damage: Principles and Practices for the Design and Construction of Flood Resistant Building Utility Systems*, FEMA 348, Washington, DC, November 1999.

Federal Emergency Management Agency (FEMA), 2000, *Coastal Construction Manual*, FEMA 55 (3rd Edition), Washington, DC.

Federal Emergency Management Agency (FEMA), 2004, *Answers to Questions about the National Flood Insurance Program*, FEMA F-084, Washington, DC, May 2004.

Federal Emergency Management Agency (FEMA), NFIP Technical Bulletins:

- *User's Guide to Technical Bulletins*, FIA-TB-0, April 1993.
- *Openings in Foundation Walls*, FIA-TB-1, April 1993.
- *Flood-Resistant Materials Requirements*, FIA-TB-2, April 1993.
- *Non-Residential Floodproofing—Requirements and Certification*, FIA-TB-3, April 1993.
- *Elevator Installation*, FIA-TB-4, April 1993.
- *Free-of-Obstruction Requirements*, FIA-TB-5, April 1993.
- *Below-Grade Parking Requirements*, FIA-TB-6, April 1993.
- *Wet Floodproofing Requirements*, FIA-TB-7, December 1993.
- *Corrosion Protection for Metal Connections in Coastal Areas*, FIA-TB-8, 1996.
- *Design and Construction Guidance for Breakaway Walls Below Elevated Coastal Buildings*, FIA-TB-9, 1999.
- *Ensuring That Structures Built on Fill In or Near Special Flood Hazard Areas Are Reasonably Safe From Flooding*, FIA-TB-10, 2001.
- *Crawlspace Construction for Buildings Located in Special Flood Hazard Areas*, FIA-TB-11, 2001.

International Code Council, Inc. (ICC), 2006a, *ICC Performance Code for Buildings and Facilities*, Country Club Hills, IL.

International Code Council, Inc. (ICC), 2006b, *International Building Code*, Country Club Hills, IL.

International Code Council, Inc. (ICC) and Federal Emergency Management Agency (FEMA), 2006, *Reducing Flood Losses Through the International Codes, Meeting the Requirements of the National Flood Insurance Program* (2006 I-Codes), Country Club Hills, IL.

National Academy of Sciences, 1977, *Methodology for Calculating Wave Action Effects Associated with Storm Surges*. Washington, DC.

National Fire Protection Association (NFPA), 2006, *Building Construction and Safety Code* (NFPA 5000), Quincy, MA.

U.S. Army Corps of Engineers, 1993, *National Flood Proofing Committee, Flood Proofing – How To Evaluate Your Options*, Washington, DC, July 1993.

U.S. Army Corps of Engineers, 1995, *Flood Proofing Regulations*, EP 1165-2-314, Washington, DC.

U.S. Army Corps of Engineers, 1996, *Flood Proofing Programs, Techniques and References*, Washington, DC.

U.S. Army Corps of Engineers, 1998, *Flood Proofing Performance—Successes & Failures*, Washington, DC.

Organizations and Agencies:

Federal Emergency Management Agency: FEMA's regional offices can be contacted for advice and guidance on NFIP mapping and regulations (www.fema.gov).

NFIP State Coordinating offices help local governments to meet their floodplain management obligations, and may provide technical advice to others; the offices are listed by the Association of State Floodplain Managers, Inc., (www.floods.org/stcoor.htm).

State agencies that coordinate state funding and or administer regulations may have state-specific requirements for hospitals.

U.S. Army Corps of Engineers: District offices offer Flood Plain Management Services, (www.usace.army.mil/inet/functions/cw/).

4.1 GENERAL DESIGN CONSIDERATIONS

Wind with sufficient speed to cause damage to weak hospitals can occur anywhere in the United States and its territories.¹ Even a well-designed, constructed, and maintained hospital may be damaged by a wind event much stronger than one the building was designed for. However, except for tornado damage, this scenario is a rare occurrence. Rather, most damage occurs because various building elements have limited wind resistance due to inadequate design, poor installation, or material deterioration. Although the magnitude and frequency of strong windstorms vary by locale, all hospitals should be designed, constructed, and maintained to minimize wind damage (other than that associated with tornadoes —see Section 4.5).

This chapter discusses structural, building envelope, and nonstructural building systems, and illustrates various types of wind-induced damage that affect them. It also presents six case studies. Numerous examples of best practices pertaining to new and existing hospitals are presented as recommended design guidelines. Incorporating those practices applicable to specific projects will result in greater wind-resistance reliability and will, therefore, decrease expenditures for repair of wind-damaged facilities, provide enhanced protection for occupants, and avoid disruption of critical services.

The recommendations presented in this manual are based on field observation research conducted on 25 hospitals that were struck by

¹ The U.S. territories include American Samoa, Guam, Northern Mariana Islands, Puerto Rico, and the U.S. Virgin Islands. ASCE 7 provides basic wind speed criteria for all but Northern Mariana Islands.

hurricanes². The recommendations are also based on numerous investigations of other types of critical facilities and other types of buildings exposed to hurricanes and tornadoes, and on literature review. Some of the 25 hospitals were exposed to extremely high wind speeds, while others experienced moderate speeds. Approximately 88 percent of the 25 hospitals experienced roof covering damage (many of which also experienced damage to rooftop equipment), and windows were broken on approximately 50 percent of them. Because of wind damage and subsequent water leakage, one of the hospitals was totally evacuated after a hurricane (Figure 4-1). Another hospital was also evacuated after a hurricane, but evacuation was prompted by flooding. Five other hospitals were partially evacuated after the storm because of interior water damage. None of the main hospital buildings on these 25 campuses experienced structural failure, although a few auxiliary buildings did collapse.

Figure 4-1:
Deering Hospital was evacuated after Hurricane Andrew due to water infiltration caused by roof covering, window, and door damage.



The 200-bed Deering Hospital opened shortly before Hurricane Andrew struck south Florida in 1992. Aggregate from the hospital's built-up roofs broke several windows, the roof covering was blown off in some areas (Figure 4-9), and the entrance doors at the emergency room were blown away. Because of extensive interior water damage, the entire hospital was evacuated after the storm and remained closed for 9 months.

² The research on the 25 hospitals was conducted by a team from Texas Tech University (Hurricane Hugo, Charleston, South Carolina, 1989), a team under the auspices of the Wind Engineering Research Council—now known as the American Association for Wind Engineering (Hurricane Andrew, South Florida, 1992), and teams deployed by FEMA (Hurricane Marilyn, U.S. Virgin Islands, 1995; Typhoon Paka, Guam, 1997; Hurricane Charley, Port Charlotte, Florida, 2004; Hurricane Frances, east coast of Florida, 2004, Hurricane Ivan, Pensacola, Florida, 2004; and Hurricane Katrina, Louisiana and Mississippi, 2005).

4.1.1 NATURE OF HIGH WINDS

A variety of windstorm types occur in different areas of the United States. The characteristics of the types of storms that can affect the site should be considered by the design team. The primary storm types are straight-line winds, down-slope winds, thunderstorms, downbursts, northeasters (nor'easters), hurricanes, and tornadoes. For information on these storm types, refer to Section 3.1.1 in FEMA 543, *Design Guide for Improving Critical Facility Safety from Flooding and High Winds*.³

Of all the storm types, hurricanes have the greatest potential for devastating a large geographical area and, hence, affect the greatest number of people. See Figure 4-2 for hurricane-prone regions.

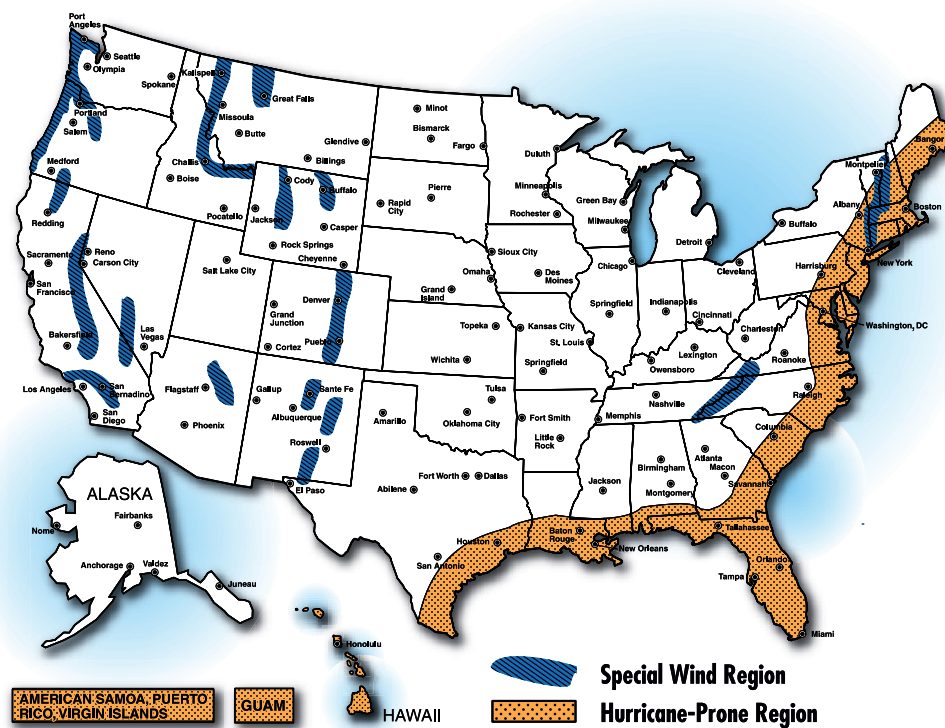

Figure 4-2: Hurricane-prone regions and special wind regions

SOURCE: ADAPTED FROM ASCE 7-05

4.1.2 PROBABILITY OF OCCURRENCE

Via the importance factor,⁴ ASCE 7 requires Category III and IV buildings to be designed for higher wind loads than Category I and II buildings. Hence, hospitals designed in accordance with ASCE 7 have greater

³ Available at the FEMA Web site. See www.fema.gov/library/viewRecord.do?id=2441

⁴ The importance factor accounts for the degree of hazard to human life and damage to property. Importance factors are given in ASCE 7.

resistance to stronger, rarer storms. When designing a hospital, design professionals should consider the following types of winds.

Routine winds: In many locations, winds with low to moderate speeds occur daily. Damage is not expected to occur during these events.

Missile damage is very common during hurricanes and tornadoes. Missiles can puncture roof coverings, many types of exterior walls, and glazing. The IBC does not address missile-induced damage, except for glazing in wind-borne debris regions. (Wind-borne debris regions are limited to portions of hurricane-prone regions.) In hurricane-prone regions, significant missile-induced building damage should be expected, even during design level hurricane events, unless special enhancements are incorporated into the building's design (discussed in Section 4.3).

Stronger winds: At a given site, stronger winds (i.e., winds with a speed in the range of 70 to 80 mph peak gust, measured at 33 feet in Exposure C—refer to Section 4.1.3) may occur from several times a year to only once a year or even less frequently. This is the threshold at which damage normally begins to occur to building elements that have limited wind resistance due to problems associated with inadequate design, insufficient strength, poor installation, or material deterioration.

Design level winds: Hospitals exposed to design level events and events that are somewhat in excess of design level should experience little, if any, damage. Actual storm history, however, has shown that design level storms frequently cause

extensive building envelope damage. Structural damage also occurs, but less frequently. Damage incurred in design level events is typically associated with inadequate design, poor installation, or material deterioration. The exceptions are wind-driven water infiltration and wind-borne debris (missiles) damage. Water infiltration is discussed in Sections 4.3.3.1, 4.3.3.3, and 4.3.3.5.

ASCE 7, *Minimum Design Loads for Buildings and Other Structures*, provides guidance for determining wind loads on buildings. The IBC and NFPA 5000 refer to ASCE 7 for wind load determination.

Tornadoes: Although more than 1,200 tornadoes typically occur each year in the United States, the probability of a tornado occurring at any given location is quite small. The probability of occurrence is a function of location. As described in Section 4.5, only a few areas of the country frequently experience tornadoes, and tornadoes are very rare in the west. The Okla-

homa City area is the most active location, with 112 recorded tornadoes between 1890 and 2003 (www.spc.noaa.gov/faq/tornado/#History).

Well-designed, constructed, and maintained hospitals should experience little if any damage from weak tornadoes, except for window breakage. However, weak tornadoes often cause building envelope damage because of wind-resistance deficiencies. Most hospitals experience significant damage if they are in the path of a strong or violent tornado because they

typically are not designed for this type of storm. See Section 4.5 for recommendations pertaining to tornadoes.

4.1.3 WIND/BUILDING INTERACTIONS

When wind interacts with a building, both positive and negative (i.e., suction) pressures occur simultaneously. Hospitals must have sufficient strength to resist the applied loads from these pressures to prevent wind-induced building failure. Loads exerted on the building envelope are transferred to the structural system, where in turn they must be transferred through the foundation into the ground. The magnitude of the pressures is a function of the following primary factors: exposure, basic wind speed, topography, building height, internal pressure, and building shape. For general information on these factors, refer to Section 3.1.3 in FEMA 543, *Design Guide for Improving Critical Facility Safety from Flooding and High Winds*. A description of key issues follows.

Wind Speed: In the ASCE 7 formula for determining wind pressures, the basic wind speed is squared. Therefore, as the wind speed increases, the pressures are exponentially increased, as illustrated in Figure 4-3. This figure also illustrates the relative difference in pressures exerted on the main wind-force resisting system (MWFRS) and the components and cladding (C&C) elements.

The MWFRS is an assemblage of structural elements assigned to provide support and stability for the overall structure. The system generally receives wind loading from more than one surface. The C&C are elements of the building envelope that do not qualify as part of the main wind-force resisting system.

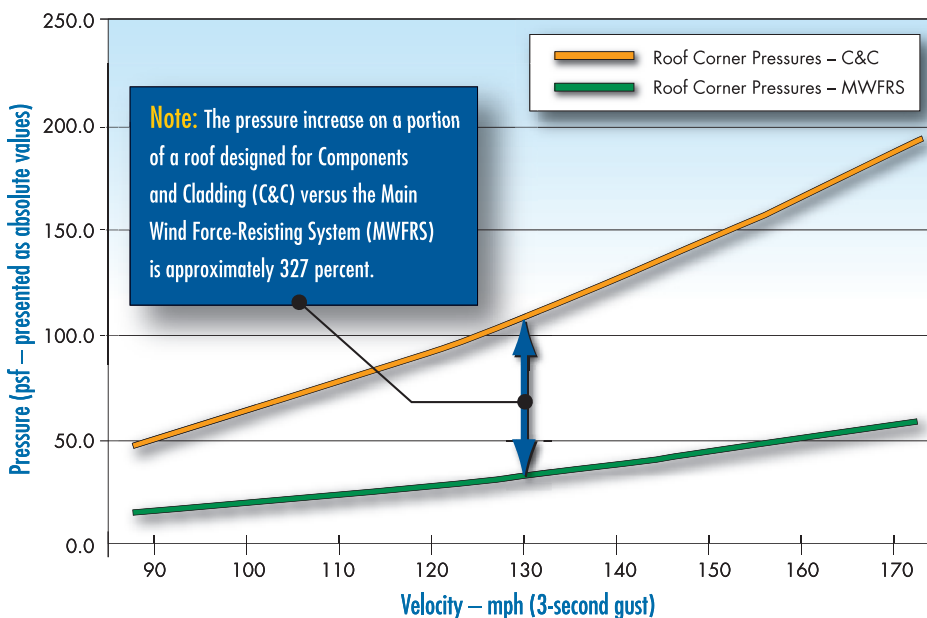
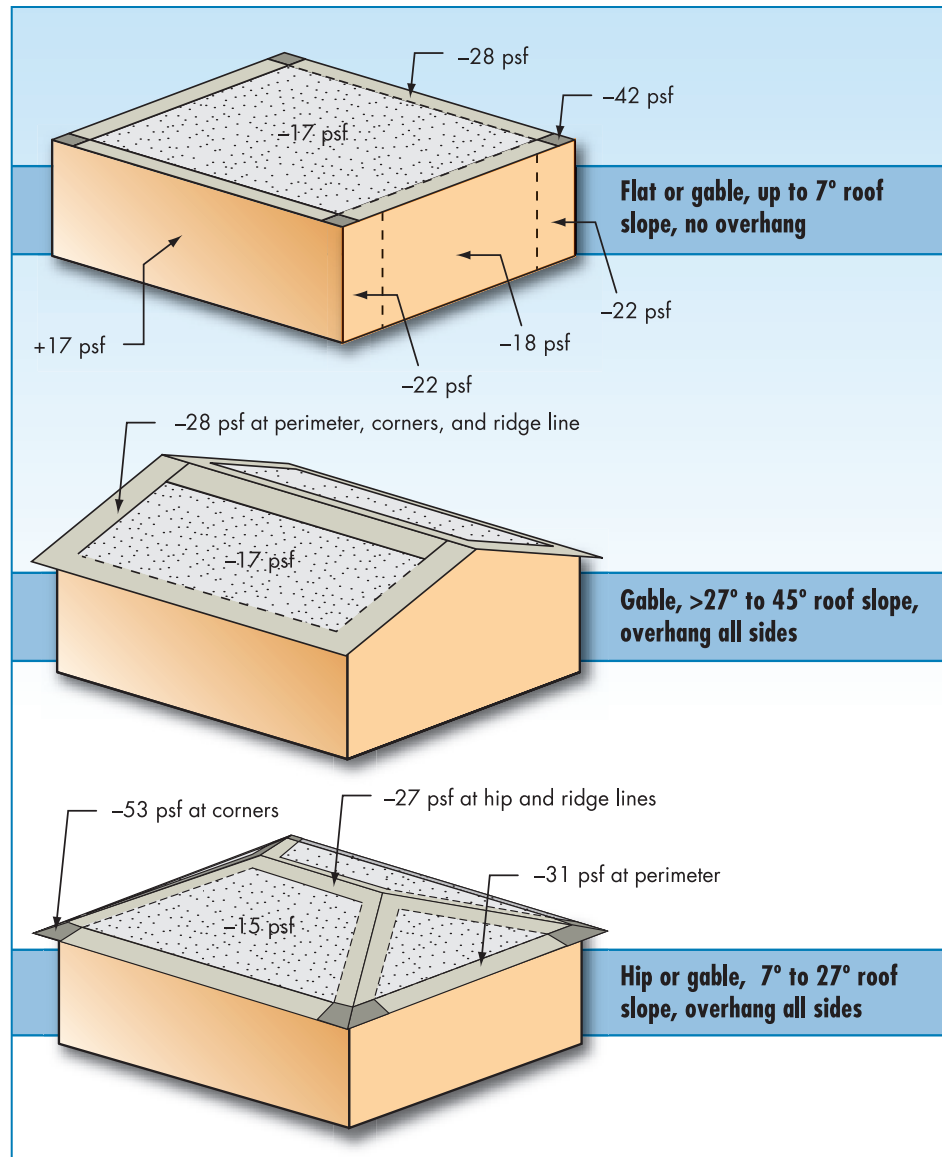

Figure 4-3: Wind pressure as a function of wind speed

Building shape: The highest uplift pressures occur at roof corners because of building aerodynamics (i.e., the interaction between the wind and the building). The roof perimeter has a somewhat lower load compared to the corners, and the field of the roof has still lower loads. Exterior walls typically have lower loads than the roof. The ends (edges) of walls have higher suction loads than the portion of wall between the ends. However, when the wall is loaded with positive pressure, the entire wall is uniformly loaded. Figure 4-4 illustrates these aerodynamic influences. The negative values shown in Figure 4-4 indicate suction pressure acting upward from the roof surface and outward from the wall surface. Positive values indicate positive pressure acting inward on the wall surface.

Figure 4-4:
Relative roof uplift pressures as a function of roof geometry, roof slope, and location on roof, and relative positive and negative wall pressures as a function of location along the wall



Aerodynamic influences are accounted for by using external pressure coefficients in load calculations. The value of the coefficient is a function of the location on the building (e.g., roof corner or field of roof) and building shape as discussed below. Positive coefficients represent a positive (inward-acting) pressure, and negative coefficients represent negative (outward-acting [suction]) pressure. External pressure coefficients for MWFRS and C&C are listed in ASCE 7.

Building shape affects the value of pressure coefficients and, therefore, the loads applied to the various building surfaces. For example, the uplift loads on a low-slope roof are larger than the loads on a gable or hip roof. The steeper the slope, the lower the uplift load. Pressure coefficients for monoslope (shed) roofs, sawtooth roofs, and domes are all different from those for low-slope and gable/hip roofs.

Building irregularities, such as re-entrant corners, bay window projections, a stair tower projecting out from the main wall, dormers, and chimneys can cause localized turbulence. Turbulence causes wind speed-up, which increases the wind loads in the vicinity of the building irregularity, as shown in Figures 4-5 and 4-6. Figure 4-5 shows the aggregate ballast on a hospital's single-ply membrane roof blown away at the re-entrant corner and in the vicinity of the corners of the wall projections at the window bays. The irregular wall surface created turbulence, which led to wind speed-up and loss of aggregate in the turbulent flow areas.

Figure 4-6 shows a stair tower at a hospital that caused turbulence resulting in wind speed-up. The speed-up increased the suction pressure on the base flashing along the parapet behind the stair tower. The built-up roof's base flashing was pulled out from underneath the coping because its attachment was insufficient to resist the suction pressure. The base flashing failure propagated and caused a large area of the roof membrane to lift and peel. Some of the wall covering on the stair tower was also blown away. Had the stair tower not existed, the built-up roof would likely not have been damaged. To avoid damage in the vicinity of building irregularities, attention needs to be given to the attachment of building elements located in turbulent flow areas.

To avoid the roof membrane damage shown in Figure 4-6, it would be prudent to use corner uplift loads in lieu of perimeter uplift loads in the vicinity of the stair tower, as illustrated in Figure 4-7. Wind load increases due to building irregularities can be identified by wind tunnel studies; however, wind tunnel studies are rarely performed for hospitals. Therefore, identification of wind load increases due to building

Information pertaining to load calculations is presented in Section 4.3.1.2. For further general information on the nature of wind and wind-building interactions, see *Buildings at Risk: Wind Design Basics for Practicing Architects*, American Institute of Architects, 1997.

irregularities will normally be based on the designer's professional judgment. Usually load increases will only need to be applied to the building envelope, and not to the MWFRS.

Figure 4-5:
Aggregate blow-off associated with building irregularities. Hurricane Hugo (South Carolina, 1989)



Figure 4-6:
The irregularity created by the stair tower (covered with a metal roof) caused turbulence resulting in wind speed-up and roof damage. Hurricane Andrew (Florida, 1992)



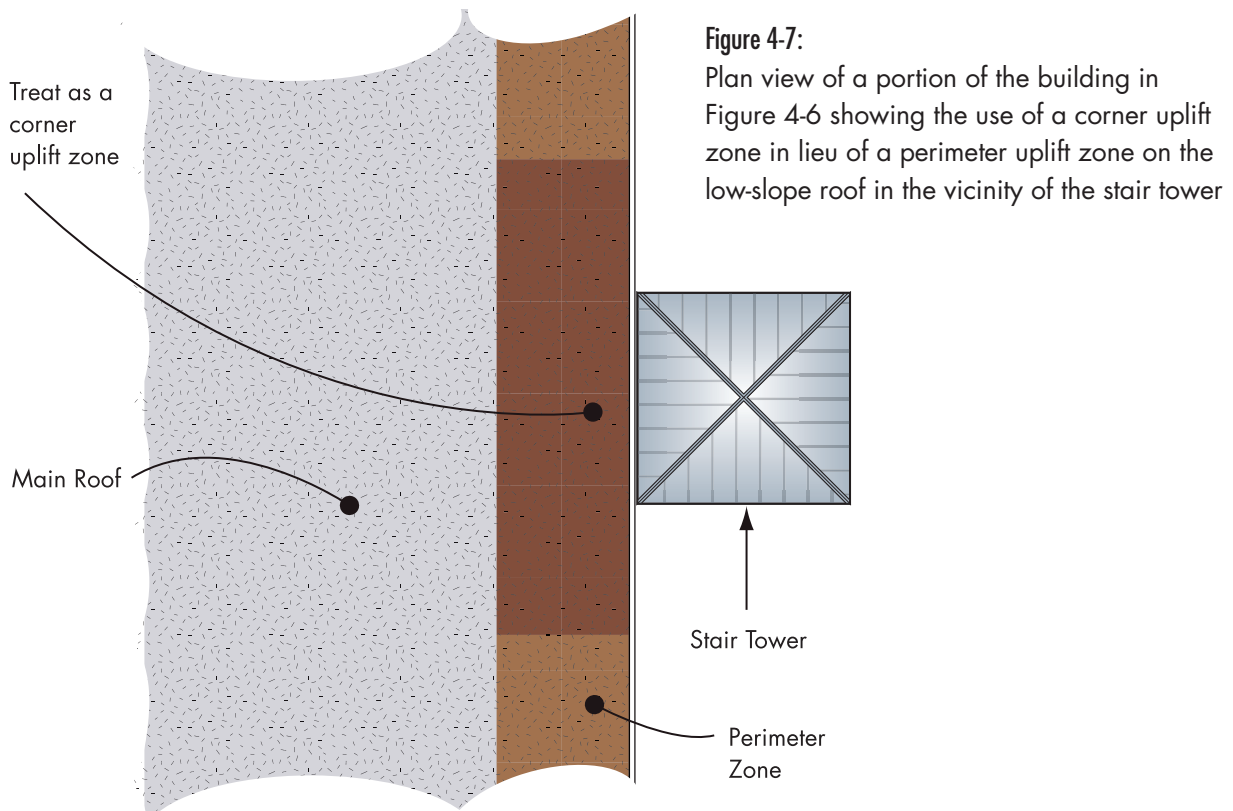

4.1.4 BUILDING CODES

The IBC is the most extensively used model code. However, in some jurisdictions NFPA 5000 may be used. In other jurisdictions, one of the earlier model building codes, or a specially written State or local building code, may be used. The specific scope and/or effectiveness and limitations of these other building codes will be somewhat different from those of the IBC. It is incumbent upon the design professionals to be aware of the specific code (including the edition of the code and local amendments) that has been adopted by the authority having jurisdiction over the location of the hospital.

4.1.4.1 Scope of Building Codes

With respect to wind performance, the scope of the model building codes has greatly expanded since the mid-1980s. Some of the most significant improvements are discussed below.

Recognition of increased uplift loads at the roof perimeter and corners: Prior to the 1982 edition of the Standard Building Code (SBC), Uniform Building Code (UBC), and the 1987 edition of the National Building Code (NBC),

these model codes did not account for the increased uplift at the roof perimeter and corners. Therefore, hospitals designed in accordance with earlier editions of these codes are very susceptible to blow-off of the roof deck and/or roof covering.

Adoption of ASCE 7 for design wind loads: Although the SBC, UBC, and NBC permitted use of ASCE 7, the 2000 edition of the IBC was the first model code to require ASCE 7 for determining wind design loads on all buildings. ASCE 7 has been more reflective of the current state of the knowledge than the earlier model codes, and use of this procedure typically has resulted in higher design loads.

ASCE 7 requires impact-resistant glazing in wind-borne debris regions within hurricane-prone regions. Impact-resistant glazing can either be laminated glass, polycarbonate, or shutters tested in accordance with standards specified in ASCE 7. The wind-borne debris load criteria were developed to minimize property damage and to improve building performance. The criteria were not developed for occupant protection. Where occupant protection is a specific criterion, the more conservative wind-borne debris criteria given in FEMA 361, *Design and Construction Guidance for Community Shelters* is recommended.

Roof coverings: Several performance and prescriptive requirements pertaining to wind resistance of roof coverings have been incorporated into the model codes. The majority of these additional provisions were added after Hurricanes Hugo (1989) and Andrew (1992). Poor performance of roof coverings was widespread in both of those storms. Prior to the 1991 edition of the SBC and UBC, and the 1990 edition of the NBC, these model codes were essentially silent on roof covering wind loads and test methods for determining uplift resistance. Code improvements continued to be made through the 2006 edition of the IBC, which added a provision that prohibits aggregate roof surfaces in hurricane-prone regions.

Glazing protection: The 2000 edition of the IBC was the first model code to address wind-borne debris requirements for glazing in buildings located in hurricane-prone regions (via reference to the 1998 edition of ASCE 7). The 1995 edition of ASCE 7 was the first edition to address wind-borne debris requirements.

Parapets and rooftop equipment: The 2003 edition of the IBC was the first model code to address wind loads on parapets and rooftop equipment (via reference to the 2002 edition of ASCE 7, which was the first edition of ASCE 7 to address these elements).

4.1.4.2 Effectiveness and Limitations of Building Codes

A key element of an effective building code is for a community to have an effective building department. Building safety depends on more than the codes and the standards they reference. Building safety results when

trained professionals have the resources and ongoing support they need to stay on top of the latest advancements in building safety. An effective building safety system provides uniform code interpretations, product evaluations, and professional development and certification for inspectors and plan reviewers. Local building departments play an important role in helping to ensure buildings are designed and constructed in accordance with the applicable building codes. Meaningful plan review and inspection by the building department are particularly important for hospitals.

General limitations to building codes include the following:

- Because codes are adopted and enforced on the local or State level, the authority having jurisdiction has the power to eliminate or modify wind-related provisions of a model code, or write its own code instead. In places where important wind-related provisions of the current model code are not adopted and enforced, hospitals are more susceptible to wind damage. Additionally, a significant time lag often exists between the time a model code is updated and the time it is implemented by the authority having jurisdiction. Buildings designed to the minimum requirements of an outdated code are, therefore, not taking advantage of the current state of the knowledge. These buildings are prone to poorer wind performance compared to buildings designed according to the current model code.
- Adopting the current model code alone does not ensure good wind performance. The code is a minimum that should be used by knowledgeable design professionals in conjunction with their training, skills, professional judgment, and the best practices presented in this manual. To achieve good wind performance, in addition to good design, the construction work must be effectively executed, and the building must be adequately maintained and repaired.
- Hospitals need to perform at a higher level than required by codes and standards.

IBC 2006: The 2006 edition of the IBC is believed to be a relatively effective code, provided that it is properly followed and enforced. Some limitations of the 2006 IBC have, however, been identified:

- With respect to hurricanes, the IBC provisions pertaining to building envelopes and rooftop equipment do not adequately address the special needs of hospitals. For example: (1) they do not account for water infiltration due to puncture of the roof membrane by missiles; (2) they do not adequately address the vulnerabilities of brittle roof coverings (such as tile) to missile-induced damage and subsequent progressive failure; (3) they do not adequately address occupant

protection with respect to missiles; (4) they do not adequately address protection of equipment in elevator penthouses; and (5) they do not account for interruption of water service or prolonged interruption of electrical power. All of these elements are of extreme importance for hospitals, which need to remain operational before, during, and after a disaster. Guidance to overcome these shortcomings is given in Section 4.3 and 4.4.

- The 2000, 2003, and 2006 IBC rely on several referenced standards and test methods developed or updated in the 1990s. Prior to adoption, most of these standards and test methods had not been validated by actual building performance during design level wind events. The hurricanes of 2004 and 2005 provided an opportunity to evaluate the actual performance of buildings designed and constructed to the minimum provisions of the IBC. Building performance evaluations conducted by FEMA revealed the need for further enhancements to the 2006 IBC pertaining to some of the test methods used to assess wind and wind-driven rain resistance of building envelope components. For example, there is no test method to assess wind resistance of gutters. Further, the test method to evaluate the resistance of windows to wind-driven rain is inadequate for high wind events. However, before testing limitations can be overcome, research needs to be conducted, new test methods need to be developed, and some existing test methods need to be modified.
- Except to the extent covered by reference to ASCE 7, the 2006 IBC does not address the requirement for continuity, redundancy, or energy-dissipating capability (ductility) to limit the effects of local collapse, and to prevent or minimize progressive collapse after the loss of one or two primary structural members, such as a column. Chapter 1 of ASCE 7 addresses general structural integrity, and the Chapter 1 Commentary provides some guidance on this issue.
- The 2006 IBC does not account for tornadoes; therefore, except for weak tornadoes, it is ineffective for this type of storm.⁵ Guidance to overcome this shortcoming is given in Section 4.5.

⁵ Except for glass breakage, code-compliant buildings should not experience significant damage during weak tornadoes.

4.2 HOSPITALS EXPOSED TO HIGH WINDS

4.2.1 VULNERABILITY: WHAT HIGH WINDS CAN DO TO HOSPITALS

This section provides an overview of the common types of wind damage and their ramifications.

4.2.1.1 Types of Building Damage

When damaged by wind, hospitals typically experience a variety of building component damage. For example, at the hospital shown in Figure 4-8, the roof covering was severely damaged, windows were broken, and rooftop equipment was blown away. The subsequent water infiltration required that most of the hospital be evacuated. The most common types of damage are discussed below in descending order of frequency.



Figure 4-8:
Field military hospital in tents set up to replace evacuated hospital in U.S. Virgin Islands following Hurricane Marilyn (1995)



Roof: Roof covering damage (including rooftop mechanical, electrical, and communications equipment) is the most common type of wind damage, as illustrated by Figure 4-9. In addition to blowoff of the roof membrane (yellow arrow), ductwork blew away (red circle), a gooseneck was blown over (red arrow), and wall panels at an equipment enclosure were blown off (blue arrow). The cast-in-place concrete deck kept most of the water from entering the hospital.

Figure 4-9:
Damaged roof membrane and rooftop equipment. Typhoon Paka (1997)



Glazing: Exterior glazing damage is very common during hurricanes and tornadoes, but is less common during other storms. The glass shown in Figure 4-10 was broken by the aggregate from a built-up roof. The inner panes had several impact craters. In several of the adjacent windows, both the outer and inner panes were broken. The aggregate flew more than 245 feet (the estimated wind speed was 104 mph, measured at 33 feet in Exposure C).

Figure 4-10:
The outer window panes were broken by aggregate from a built-up roof. Hurricane Hugo (South Carolina, 1989)



Wall coverings, soffits, and large doors: Exterior wall covering, soffit, and large door damage is common during hurricanes and tornadoes, but is less common during other storms. Wall covering damage is shown at the hospital complex described in the West Florida Hospital case study, Section 4.1.3.

Wall collapse: Collapse of non-load-bearing exterior walls is common during hurricanes and tornadoes, but is less common during other storms. At the hospital shown in Figure 4-11, a portion of the non-load-bearing wall collapsed. Several windows were also broken by aggregate ballast blown from the hospital's roof (see Figure 4-5).



Figure 4-11: Collapse of non-load-bearing wall (red circle) and broken glazing from roof aggregate (red arrow). Hurricane Hugo (South Carolina, 1989)

Structural system: Structural damage (e.g., roof deck blow-off, blow-off or collapse of the roof structure, collapse of exterior bearing walls, or collapse of the entire building or major portions thereof) is the principal type of damage that occurs during strong and violent tornadoes (see Figure 4-12)



Figure 4-12: This building in Northern Illinois was heavily damaged by a strong tornado in 1990.

4.2.1.2 Ramifications of Damage

The ramifications of building component damage on hospitals are described below.

Property damage: Property damage requires repairing/replacing the damaged components (or replacing the entire facility), and may require repairing/replacing interior building components, furniture, and other equipment, and mold remediation. As illustrated by Figures 4-1 and 4-8, even when damage to the building envelope is limited, such as blow-off of a portion of the roof covering or broken glazing, substantial water damage frequently occurs because heavy rains often accompany strong winds (particularly in the case of thunderstorms, tropical storms, hurricanes, and tornadoes).

Wind-borne debris such as roof aggregate, gutters, rooftop equipment, and siding blown from buildings can damage vehicles and other buildings in the vicinity. Debris can travel well over 300 feet in high-wind events.

Modest wind speeds can drive rain into exterior walls. Unless adequate provisions are taken to account for water infiltration (see Sections 4.3.3.1 – 4.3.3.6), damaging corrosion, dry rot, and mold can occur within walls.

Ancillary buildings (such as storage buildings) adjacent to hospitals are also vulnerable to damage. Although loss of these buildings may not be crippling to the operation of the hospital, debris from ancillary buildings may strike and damage the hospital.

Injury or death: Although infrequent, hospital occupants or people outside hospitals may be injured and killed if struck by collapsed building components (such as exterior masonry walls or the roof structure) or wind-borne debris. The greatest risk of injury or death is during strong hurricanes and strong/violent tornadoes. If a hospital, or a portion of a hospital, needs to be evacuated due to wind-related damage, patients may be exposed to risk of injury or death during their relocation.

Interrupted use: Depending on the magnitude of wind and water damage, it can take days, months, or more than a year to repair the damage or

Although people are not usually outside during hurricanes, it is not uncommon for people to seek medical care during a storm. Missiles, such as roof aggregate or tile shedding from a hospital, could injure or kill people before they have a chance to enter the building.

replace a facility. In addition to the costs associated with repairing/replacing the damage, other social and financial costs can be even more significant. The repercussions related to interrupted use of hospitals can include lack of medical care, and the costs to rent temporary facilities. These additional costs can be quite substantial.

4.2.1.3 The Case of West Florida Hospital, Pensacola, Florida

The case of West Florida Hospital illustrates a variety of building performance problems. The 531-bed West Florida Healthcare facility (also called the Pavillion) includes the 400-bed acute tertiary West Florida Hospital, the 58-bed Rehabilitation Institute, and a 73-bed behavioral health facility. The Pavillion is located north of downtown Pensacola, approximately 3 miles west of Escambia Bay and 7 miles north of Pensacola Bay. West Florida was struck by Hurricane Ivan in 2004. The estimated peak gust wind speed at this site was 105 to 115 mph.⁶ The design wind speed in the 2005 edition of ASCE 7 for this location is 135 mph.

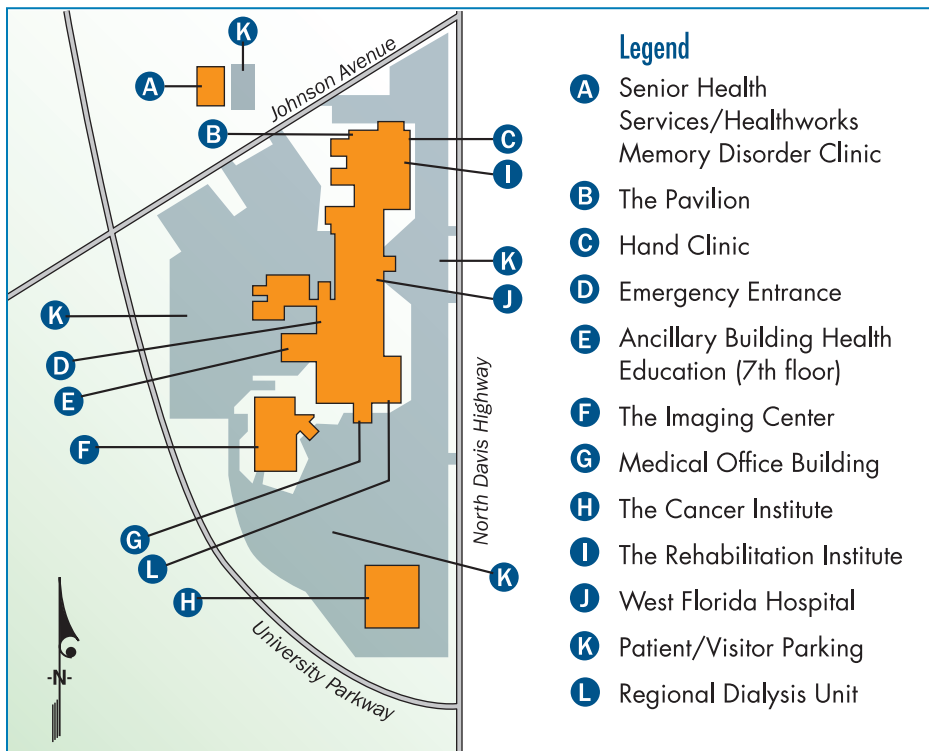

Figure 4-13: Site plan

The West Florida Hospital (J on Figure 4-13) and several of the other buildings on the campus experienced a variety of damages during the storm. The roof membrane was punctured in several places by windborne missiles and by damaged rooftop equipment (see Figures 4-14 to 4-16).

Exterior insulation finish system (EIFS) blew off the hospital and caused significant glass breakage in the MOB (Figure 4-17) and the walkway connecting the hospital to the MOB. Some of the lower-level windows may have been broken by wind-blown aggregate ballast from the roof over the dialysis unit and urgent care facility. In addition, some window frames

⁶ The 105 to 115 mph speeds were estimated for Exposure C.

were reportedly blown out. These failures were likely caused by the development of high internal pressure after windows on windward surfaces were broken by missiles, combined with suction pressure on the exterior surface of windows on the leeward side of the building. Glass damage to the MOB, and subsequent wind and water damage to the interior, resulted in closure of several offices.

In addition to the window breakage, EIFS blew off the elevator enclosure, the stair tower, and the spandrels. The single-ply roof membrane was damaged and the Lightning Protection System (LPS) on the MOB was also displaced.

The hospital originally had exposed concrete walls. However, in a subsequent refurbishing, the walls were faced with EIFS. Steel hat channels were installed over the concrete, followed by gypsum board, insulation, and synthetic stucco. In areas where the EIFS blew off, the gypsum board typically pulled over the screw heads and blew away (Figure 4-23). The screws and hat channels were moderately corroded. Although the corrosion could have eventually caused loss of the EIFS, it did not play a role in this failure.

With loss of the EIFS wall covering, wind-driven rain destroyed the elevator control equipment (see Figure 4-22). Water damage to the elevator control equipment resulted in failure of the MOB stair tower elevator. As a result, several people were trapped in the MOB stair tower elevator shown in Figure 4-18 during the hurricane. Fortunately, the MOB had another bank of elevators in the core of the building that was not damaged, so vertical transportation was still possible, although handicapped by the loss of the stair tower elevator. At the MOB stair tower, some of the gypsum board on the interior side of the studs collapsed into the stairway, thus trapping a maintenance worker who had gone to the mechanical penthouse during the hurricane.

Glass shards from the MOB punctured the ballasted single-ply membrane over the regional dialysis unit and urgent care facility (item L on Figure 4-13). Although the roof membrane had been punctured in numerous areas (Figure 4-20), the concrete deck (concrete topping over metal decking) over the dialysis unit and urgent care facility acted as a secondary line of protection against water leakage and was effective in minimizing water infiltration into the facility, thereby minimizing interrupted use of these facilities. By quickly performing emergency roof repairs and cleaning up the interior, the dialysis unit was non-operational for only 1 day.

At the cancer treatment facility (H on Figure 4-13), asphalt shingles were blown from the roof hips and some eave edge metal lifted. Additionally,

sewage backed up at this facility because of power loss to a lift station. Sewage backup was cleaned up quickly and the facility was non-operational for only 1 day.

At the imaging center (F on Figure 4-13), there were some broken windows and a fan cowling blew away. Some large parking lot light fixtures also collapsed because the bottoms of the tubes were severely corroded (Figure 4-21).

Communications outside of the hospital were lost about an hour after the arrival of high winds because of damage to the communications antenna; the LPS was also displaced (Figure 4-15). A canopy at the loading dock was blown away, which caused difficulties in materials handling.

Because of rapid emergency response by construction and clean-up crews, the hospital and other facilities on campus remained functional. However, the damage was very costly and created many hardships for hospital staff.



Figure 4-14: Numerous repairs where the modified bitumen roof membrane was punctured by missiles. Water from the punctured membrane entered the surgical suite.

Figure 4-15:
Damaged rooftop equipment (red arrows), collapsed antenna (circled), and displaced LPS (yellow arrows)

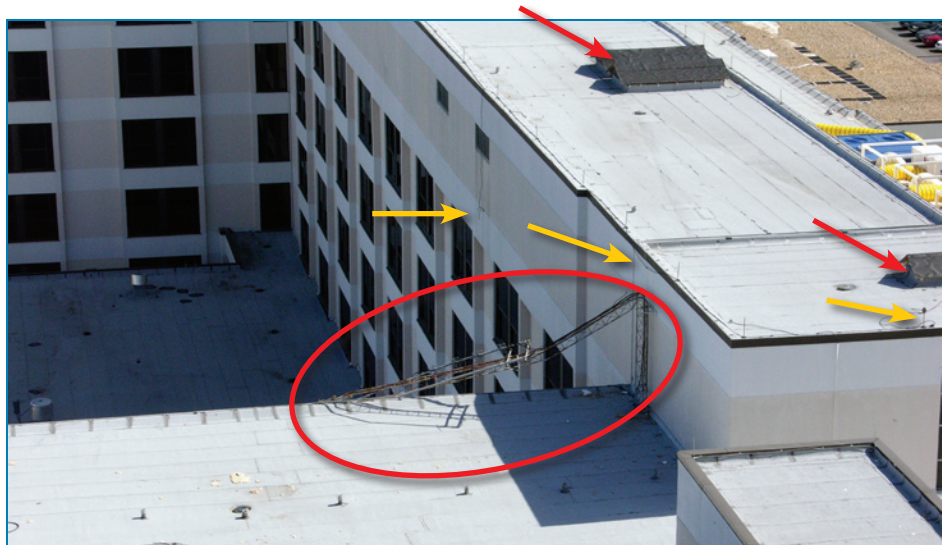

Figure 4-16:
Damaged rooftop equipment. Although some of this damage may have been caused by wind pressure, some of it was caused by missiles. Note the open ducts (red arrows).

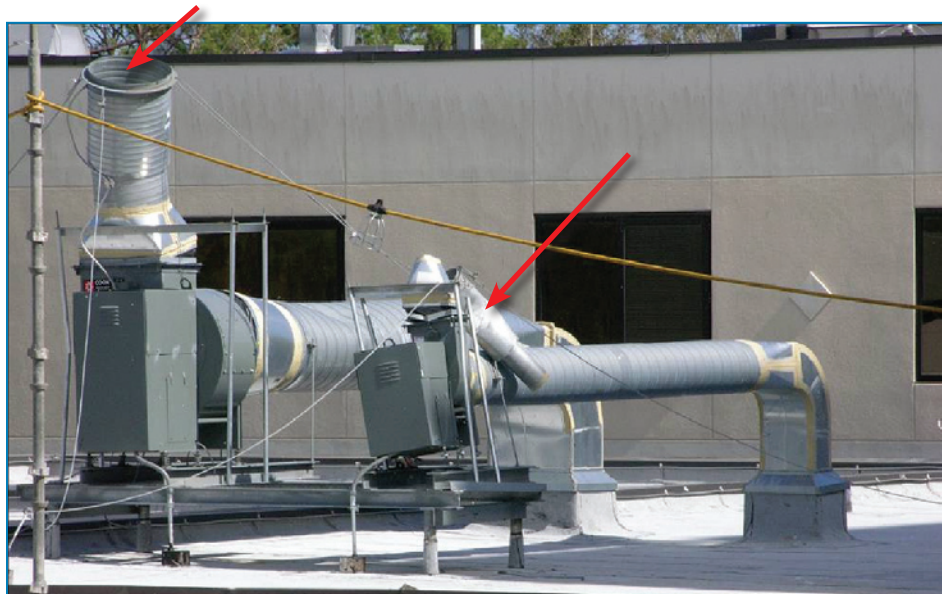

Figure 4-17:
Broken windows in the MOB. Wood studs and gypsum board had been temporarily installed after the hurricane to prevent patients from inadvertently falling out of the MOB.





Figure 4-18:
Broken windows in the connecting walkway between the hospital (right) and MOB (left) (red arrow). Also note the broken windows and loss of EIFS (including the gypsum board on both sides of the studs) at the elevator enclosure (blue arrow).



Figure 4-19:
EIFS debris blown off the hospital building (Item J on Figure 4-13) in the background (red square) broke numerous windows in the MOB (item G on figure 4-13) in the foreground.

Figure 4-20:
Looking down at the one-story roof to the right of the MOB in Figure 4-19. The small dark areas are locations where emergency patches had been placed to repair punctures from falling glass shards. (Note: At the time the photo was taken, the ballast had been repositioned into rows in preparation for removal)



Figure 4-21:
Collapsed light fixtures caused by severe corrosion (see inset). The cancer treatment facility is beyond to the left.



Figure 4-22: The only remaining portion of the exterior wall surrounding the elevator penthouse on the MOB was the steel studs.



Figure 4-23: Close-up of the damaged EIFS at the hospital. In this area most of the insulation and gypsum board was blown from the steel furring channels.

4.2.2 EVALUATING HOSPITALS FOR RISK FROM HIGH WINDS

This section describes the process of hazard risk assessment. Although no formal methodology for risk assessment has been adopted, prior experience provides a sufficient knowledge base upon which a set of guidelines can be structured into a recommended procedure for risk assessment of hospitals. The procedures presented below establish guidelines for evaluating the risk to new and existing buildings from windstorms other than tornadoes. These evaluations will allow development of a vulnerability assessment that can be used along with the site's wind regime to assess the risk to hospitals.

In the case of tornadoes, neither the IBC nor ASCE 7 requires buildings (including hospitals) to be designed to resist tornado forces, nor are occupant shelters required in buildings located in tornado-prone regions. Constructing tornado-resistant hospitals is extremely expensive because of the extremely high pressures and missile impact loads that tornadoes can generate. Therefore, when consideration is voluntarily given to tornado design, the emphasis is typically on occupant protection, which is achieved by “hardening” portions of a hospital for use as safe havens. FEMA 361 includes a comprehensive risk assessment procedure that designers can use to assist building owners in determining whether a tornado shelter should be included as part of a new hospital. See Section 4.5 for recommendations pertaining to hospitals in tornado-prone regions.

4.2.2.1 New Buildings

When designing new hospitals, a two-step procedure is recommended for evaluating the risk from windstorms (other than tornadoes).

Step 1: Determine the basic wind speed from ASCE 7. As the basic wind speed increases beyond 90 mph, the risk of damage increases. Design, construction, and maintenance enhancements are recommended to compensate for the increased risk of damage (see Section 4.3).

Step 2: For hospitals in hurricane-prone regions, refer to the design, construction, and maintenance enhancements recommended in Sections 4.3.1.5, 4.3.2.1, 4.3.3.2, 4.3.3.4, 4.3.3.6, 4.3.3.8, 4.3.4.2, 4.3.4.4, 4.3.5, and 4.3.6.

For hospitals in remote areas outside of hurricane-prone regions, it is recommended that robust design measures be considered to minimize the potential for disruption resulting from wind damage. Because of their

remote location, disruption of hospitals could severely affect patients. Some of the recommendations in the sections pertaining to hurricane-prone regions may therefore be prudent.

4.2.2.2 Existing Buildings

The resistance of existing buildings is a function of their original design and construction, various additions or modifications, and the condition of building components (which may have weakened due to deterioration or fatigue). For existing buildings, a two-step procedure is also recommended.

Step 1: Calculate the wind loads on the building using the current edition of ASCE 7, and compare these loads with the loads for which the building was originally designed. The original design loads may be noted on the contract drawings. If not, determine what building code or standard was used to develop the original design loads, and calculate the loads using that code or standard. If the original design loads are significantly lower than current loads, upgrading the load resistance of the building envelope and/or structure should be considered. An alternative to comparing current loads with original design loads is to evaluate the resistance of the existing facility as a function of the current loads to determine what elements are highly overstressed.

Step 2: Perform a field investigation to evaluate the primary building envelope elements, rooftop equipment, and structural system elements, to determine if the facility was generally constructed as indicated on the original contract drawings. As part of the investigation, the primary elements should be checked for deterioration. Load path continuity should also be checked.

If the results of either step indicate the need for remedial work, see Section 4.4.

4.3 REQUIREMENTS AND BEST PRACTICES IN HIGH-WIND REGIONS

4.3.1 GENERAL HOSPITAL DESIGN CONSIDERATIONS

The performance of hospitals in past wind storms indicates that the most frequent and the most significant factor in the disruption of the operations of these facilities has been the failure of nonstructural building components. While acknowledging the importance of the structural systems, Chapter 4 emphasizes the building envelope components and the nonstructural systems. According to National Institute of Building Sciences (NIBS), the building envelope includes the below-grade basement walls and foundation and floor slab (although these are generally considered part of the building's structural system). The envelope includes everything that separates the interior of a building from the outdoor environment, including the connection of all the nonstructural elements to the building structure. The nonstructural systems include all mechanical, electrical, electronic, communications, and lightning protection systems. Historically, damage to roof coverings and rooftop equipment has been the leading cause of building performance problems during windstorms. Special consideration should be given to the problem of water infiltration through failed building envelope components, which can cause severe disruptions in the functioning of hospitals.

The key to enhanced wind performance is paying sufficient attention to all phases of the construction process (including site selection, design, and construction) and to post-occupancy maintenance and repair.

Hospital Design Considerations In Hurricane-Prone Regions

Following the general design and construction recommendations, this manual presents recommendations specific to hospitals located in hurricane-prone regions. These recommendations are additional to the ones presented for hospitals located outside of hurricane-prone regions,

and in many cases supersede those recommendations. Hospitals located in hurricane-prone regions require special design and construction attention because of the unique characteristics of this type of windstorm. Hurricanes can bring very high winds that last for many hours, which can lead to material fatigue failures. The variability of wind direction increases the probability that the wind will approach the building at the most critical angle. Hurricanes also generate a large amount of wind-borne debris, which can damage various building components and cause injury and death.

Hospitals in hurricane-prone regions require special attention because they normally have vulnerable occupants (patients) at the time of a hurricane, and afterwards, many injured people seek medical care. Significant damage to a hospital can put patients at risk and jeopardize delivery of care to those seeking treatment. In order to ensure continuity of service during and after hurricanes, the design, construction, and maintenance of hospitals should be very robust to provide sufficient resiliency to withstand the effects of hurricanes.

Because of advanced warning of impending land fall, with the exception of Hurricane Katrina (Louisiana and Mississippi, 2005), the death toll from hurricanes in the U.S. has been extremely low for the last several decades. However, large numbers of people are often injured and seek care at hospitals. Blunt-force trauma injuries caused by wind-borne debris, falling trees, collapsed ceilings, or partial building collapse occur during hurricanes. But most of the hurricane-related injuries typically occur in the days afterward. These injuries are typically due to chainsaw accidents, stepping on nails, lacerations incurred while removing debris, vehicle accidents at intersections that no longer have functional traffic lights, people falling off roofs as they attempt to make emergency repairs, and carbon monoxide poisoning or electrical shock from improper use of emergency generators. Therefore, at a time when many hospitals in an area may be functionally impaired or no longer capable of providing service due to building damage (Figures 4-1 and 4-8), hospital staffs are faced with a higher than normal number of people seeking treatment. Before arrival of a hurricane, hospitals also often receive an influx of women in their third trimester of pregnancy, so that they will already be at the hospital in case they go into labor during the storm or shortly thereafter, when getting to the hospital could be hazardous or impossible.

Full or partial evacuation of a hospital prior to, during, or after a hurricane is time consuming, expensive, and for some patients, potentially life threatening. Water infiltration that could damage electrical equipment or medical supplies, or inhibit the use of critical areas (such as operating rooms and nursing floors) needs to be prevented. The emergency and standby power systems need to remain operational and be adequately sized to power all needed circuits, including the HVAC system. Provisions are needed for water and sewer service in the event of loss of municipal services, and antenna towers need to be strong enough to resist the wind.

4.3.1.1 Site

When selecting land for a hospital, sites located in Exposure D (see ASCE 7 for exposure definitions) should be avoided if possible. Selecting a site in Exposure C or preferably in Exposure B would decrease the wind loads. Also, where possible, avoid selecting sites located on an escarpment or the upper half of a hill, where the abrupt change in the topography would result in increased wind loads.⁷

Trees with trunks larger than 6 inches in diameter, poles (e.g., light fixture poles, flagpoles, and power poles), or towers (e.g., electrical transmission and large communication towers) should not be placed near the building. Falling trees, poles, and towers can severely damage a hospital and injure the occupants (see Figure 4-24). Large trees can crash through pre-engineered metal buildings and wood frame construction. Falling trees can also rupture roof membranes and break windows.

Figure 4-24:
The roof membrane on this hospital's materials management facility was ruptured by falling trees. Hurricane Ivan (Florida, 2004)



Street signage should be designed to resist the design wind loads so that toppled signs do not block access roads or become wind-blown debris. AASHTO LTS-4-M (amended by LTS-4-12 2001 and 2003, respectively) provides guidance for determining wind loads on highway signs.

Providing at least two means of site egress is prudent for all hospitals, but is particularly important for hospitals in hurricane-prone regions. If one route becomes blocked by trees or other debris, or by floodwaters, the other access route may still be available.

⁷ When selecting a site on an escarpment or the upper half of a hill is necessary, the ASCE 7 design procedure accounts for wind speed-up associated with this abrupt change in topography.

4.3.1.2 Building Design

Good wind performance depends on good design (including details and specifications), materials, installation, maintenance, and repair. A significant shortcoming in any of these five elements could jeopardize the performance of a hospital against wind. Design, however, is the key element to achieving good performance of a building against wind damage. Design inadequacies frequently cannot be compensated for with other elements. Good design, however, can compensate for other inadequacies to some extent. The following steps should be included in the design process for hospitals.

Step 1: Calculate Loads

Calculate loads on the MWFRS, the building envelope, and rooftop equipment in accordance with ASCE 7 or the local building code, whichever procedure results in the highest loads. In calculating wind loads, design professionals should consider the following items.

Importance factor: The effect of using a 1.15 importance factor versus 1 is that the design loads for the MWFRS and C&C are increased by 15 percent. The importance factor for hospitals is required to be 1.15. However, some buildings on a hospital campus, such as medical office buildings that are integrally connected to the hospital and various types of non-emergency treatment facilities (such as storage, cancer treatment, physical therapy, and dialysis), are not specifically required by ASCE 7 to be designed with a 1.15 factor. This manual recommends a value of 1.15 for all facilities on a hospital campus.

Wind directionality factor: The ASCE 7 wind load calculation procedure incorporates a wind directionality factor (k_d). The directionality factor accounts for the reduced probability of maximum winds coming from any given direction. By applying the prescribed value of 0.85, the loads are reduced by 15 percent. Because hurricane winds can come from any direction, and because of the historically poor performance of building envelopes and rooftop equipment, this manual recommends a more conservative approach for

In the past, design professionals seldom performed load calculations on the building envelope (i.e., roof and wall coverings, doors, windows, and skylights) and rooftop equipment. These building components are the ones that have failed the most during past wind events. In large part they failed because of the lack of proper load determination and inappropriate design of these elements. It is imperative that design professionals determine the loads for the building envelope and rooftop equipment, and design them to accommodate such loads.

Uplift loads on roof assemblies can also be determined from FM Global (FMG) Data Sheets. If the hospital is FMG insured, and the FMG-derived loads are higher than those derived from ASCE 7 or the building code, the FMG loads should govern. However, if the ASCE 7 or code-derived loads are higher than those from FMG, the ASCE 7 or code-derived loads should govern (whichever procedure results in the highest loads).

hospitals in hurricane-prone regions. A directionality factor of 1.0 is recommended for the building envelope and rooftop equipment (a load increase over what is required by ASCE 7). For the MWFRS, a directionality factor of 0.85 is recommended (hence, no change for MWFRS).

Step 2: Determine Load Resistance

When using allowable stress design, after loads have been determined, it is necessary to determine a reasonable safety factor in order to select the minimum required load resistance. For building envelope systems, a minimum safety factor of 2 is recommended. For anchoring exterior-mounted mechanical, electrical, and communications equipment (such as satellite dishes), a minimum safety factor of 3 is recommended. When using strength design, load combinations and load factors specified in ASCE 7 are used.

When using allowable stress design, a safety factor is applied to account for reasonable variations in material strengths, construction workmanship, and conditions when the actual wind speed somewhat exceeds the design wind speed. For design purposes, the ultimate resistance an assembly achieves in testing is reduced by the safety factor. For example, if a roof assembly resisted an uplift pressure of 100 pounds per square foot (psf), after applying a safety factor of 2, the assembly would be suitable where the design load was 50 psf or less. Conversely, if the design load is known, multiplying it by the safety factor equals the minimum required test pressure (e.g., 50 psf design load multiplied by a safety factor of 2 equals a minimum required test pressure of 100 psf).

ASCE 7 provides criteria for combining wind loads with other types of loads (such as dead and flood loads) using allowable stress design.

For structural members and cladding elements where strength design can be used, load resistance can be determined by calculations. For other elements where allowable stress design is used (such as most types of roof coverings), load resistance is primarily obtained from system testing.

The load resistance criteria need to be provided in contract documents. For structural elements, the designer of record typically accounts for load resistance by indicating the material, size, spacing, and connection of the elements. For nonstructural elements, such as roof coverings or windows, the load and safety factor can be specified. In this case, the specifications should require the contractor's submittals to demonstrate that the system

will meet the load resistance criteria. This performance specification approach is necessary if, at the time of the design, it is unknown who will manufacture the system.

Regardless of which approach is used, it is important that the designer of record ensure that it can be demonstrated, via calculations or tests, that the structure, building envelope, and nonstructural systems (exterior-

mounted mechanical, electrical, and communications equipment) have sufficient strength to resist design wind loads.

Step 3: Detailed Design

It is vital to design, detail, and specify the structural system, building envelope, and exterior-mounted mechanical, electrical, and communications equipment to meet the factored design loads (based on appropriate analytical or test methods). It is also vital to respond to the risk assessment criteria discussed in Section 4.2.2, as appropriate.

As part of the detailed design effort, load path continuity should be clearly indicated in the contract documents via illustration of connection details. Load paths need to accommodate design uplift, racking, and overturning loads. Load path continuity obviously applies to MWFRS elements, but it also applies to building envelope elements. Figure 4-25 shows a load path discontinuity between a piece of HVAC equipment and its equipment stand. The equipment on this new building blew away because it was resting on vibration isolators that provided lateral resistance, but no uplift resistance (also see Figure 4-92).

Connections are a key aspect of load path continuity between various structural and nonstructural building elements. In a window, for example, the glass must be strong enough to resist the wind pressure and must be adequately anchored to the window frame, the frame adequately anchored to the wall, the wall to the foundation, and the foundation to the ground. As loads increase, greater load capacity must be developed in the connections.

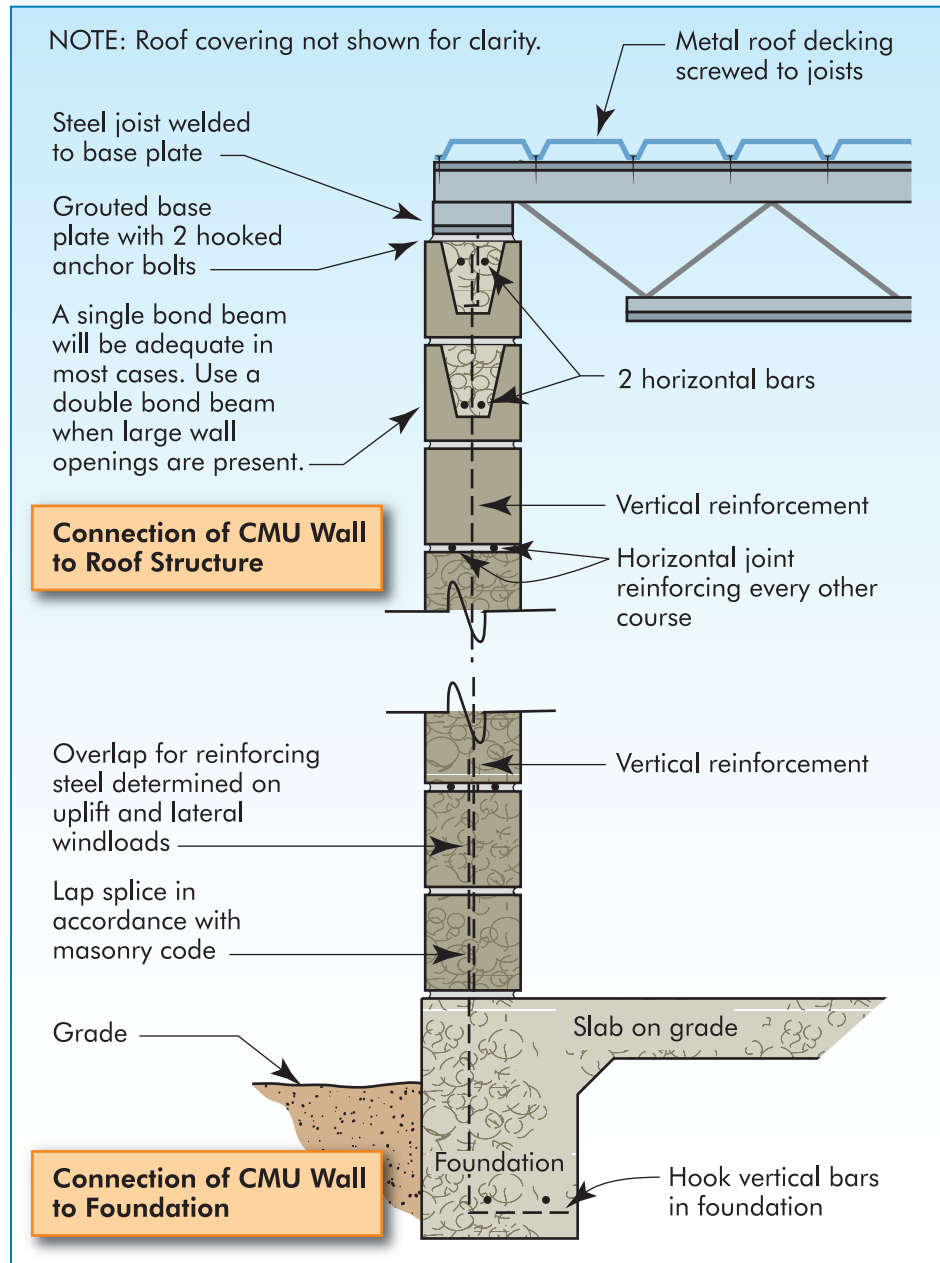

Figure 4-25: Temporary coverings placed over two large openings in the roof that were left after the ductwork blew away. Hurricane Katrina (Mississippi, 2005)

Figure 4-26 illustrates the load path concept. Members are sized to accommodate the design loads. Connections are designed to transfer uplift loads applied to the roof, and the positive and negative loads applied to

the exterior bearing walls, down to the foundation and into the ground. The roof covering (and wall covering, if there is one) is also part of the load path. To avoid blow-off, the nonstructural elements must also be adequately attached to the structure.

Figure 4-26:
Illustration of load path continuity



As part of the detailed design process, special consideration should be given to the durability of materials and water infiltration.

Durability: Because some locales have very aggressive atmospheric corrosion (such as areas near oceans), special attention needs to be given to the specification of adequate protection for ferrous metals, or to specify

alternative metals such as stainless steel. FEMA Technical Bulletin, *Corrosion Protection for Metal Connectors in Coastal Areas* (FIA-TB-8, 1996), contains information on corrosion protection. Attention also needs to be given to dry rot avoidance, for example, by specifying preservative-treated wood or developing details that avoid excessive moisture accumulation. Appendix J of the *Coastal Construction Manual*, (FEMA 55, 2000) presents information on wood durability.

Durable materials are particularly important for components that are inaccessible and cannot be inspected regularly (such as fasteners used to attach roof insulation). Special attention also needs to be given to details. For example, details that do not allow water to stand at connections or sills are preferred. Without special attention to material selection and details, the demands on maintenance and repair will be increased, along with the likelihood of failure of components during high winds.

Further information on the rain-screen principle can be found in the National Institute of Building Sciences' Building Envelope Design Guide (www.wbdg.org/design/envelope.php).

Water infiltration (rain): Although prevention of building collapse and major building damage is the primary goal of wind-resistant design, consideration should also be given to minimizing water damage and subsequent development of mold from the penetration of wind-driven rain. To the extent possible, non-load-bearing walls and door and window frames should be designed in accordance with rain-screen principles. With this approach, it is assumed that some water will penetrate past the face of the building envelope. The water is intercepted in an air-pressure equalized cavity that provides drainage from the cavity to the outer surface of the building. See Sections 4.3.3.1 and 4.3.3.5, and Figure 4-45 for further discussion and an example.

Coastal environments are conducive to metal corrosion, especially in buildings within 3,000 feet of the ocean. Most jurisdictions require metal building hardware to be hot-dipped galvanized or stainless steel. Some local codes require protective coatings that are thicker than typical "off-the-shelf" products. For example, a G90 zinc coating (0.75 mil on each face) may be required. Other recommendations include the following:

- Use hot-dipped galvanized or stainless steel hardware. Reinforcing steel should be fully protected from corrosion by the surrounding material (masonry, mortar, grout, or concrete). Use galvanized or epoxy-coated reinforcing steel in situations where the potential for corrosion is high.
- Avoid joining dissimilar metals, especially those with high galvanic potential.
- Avoid using certain wood preservatives in direct contact with galvanized metal. Verify that wood treatment is suitable for use with galvanized metal, or use stainless steel.
- Metal-plate-connected trusses should not be exposed to the elements. Truss joints near vent openings are more susceptible to corrosion and may require increased corrosion protection.

Note: *Although more resistant than other metals, stainless steel is still subject to corrosion.*

In conjunction with the rain-screen principle, it is desirable to avoid using sealant as the first or only line of defense against water infiltration. When sealant joints are exposed, obtaining long-lasting watertight performance is difficult because of the complexities of sealant joint design and installation (see Figure 4-45, which shows the sealant protected by a removable stop).

Step 4: Peer Review

If the design team's wind expertise and experience is limited, wind design input and/or peer review should be sought from a qualified individual. The design input or peer review could be arranged for the entire building, or for specific components, such as the roof or glazing systems, that are critical and beyond the design team's expertise.

Regardless of the design team's expertise and experience, peer review should be considered when a hospital:

- Is located in an area where the basic wind speed is greater than 90 mph (peak gust).
- Will incorporate a tornado shelter.

4.3.1.3 Construction Contract Administration

After a suitable design is complete, the design team should endeavor to ensure that the design intent is achieved during construction. The key elements of construction contract administration are submittal reviews and field observations, as discussed below.

Submittal reviews: The specifications need to stipulate the submittal requirements. This includes specifying what systems require submittals (e.g., windows) and test data (where appropriate). Each submittal should demonstrate the development of a load path through the system and into its supporting element. For example, a window submittal should show that the glazing has sufficient strength, its attachment to the frame is adequate, and the attachment of the frame to the wall is adequate.

During submittal review, it is important for the designer of record to be diligent in ensuring that all required documents are submitted and that they include the necessary information. The submittal information needs to be thoroughly checked to ensure its validity. For example, if an approved method used to demonstrate compliance with the design load has been altered or incorrectly applied, the test data should be rejected, unless the contractor can demonstrate the test method was suitable.

Similarly, if a new test method has been developed by a manufacturer or the contractor, the contractor should demonstrate its suitability.

Field observations: It is recommended that the design team analyze the design to determine which elements are critical to ensuring high-wind performance. The analysis should include the structural system and exterior-mounted electrical equipment, but it should focus on the building envelope and exterior-mounted mechanical and communications equipment. After determining the list of critical elements to be observed, observation frequency and the need for special inspections by an inspection firm should be determined. Observation frequency and the need for special inspections will depend on the magnitude of the results of the risk assessment described in Section 4.2.2, complexity of the facility, and the competency of the general contractor, subcontractors, and suppliers.

4.3.1.4 Post-Occupancy Inspections, Periodic Maintenance, Repair, and Replacement

The design team should advise the building owner of the importance of periodic inspections, maintenance, and timely repair. It is important for the building owner to understand that a facility's wind resistance will degrade over time due to exposure to weather unless it is regularly maintained and repaired. The goal should be to repair or replace items before they fail in a storm. This approach is less expensive than waiting for failure and then repairing the failed components and consequential damage.

The building envelope and exterior-mounted equipment should be inspected once a year by persons knowledgeable of the systems/materials they are inspecting. Items that require maintenance, repair, or replacement should be documented and scheduled for work. For example, the deterioration of glazing is often overlooked. After several years of exposure, scratches and chips can become extensive enough to weaken the glazing. Also, if an engineered film was surface-applied to glazing for wind-borne debris protection, the film should be periodically inspected and replaced before it is no longer effective.

A special inspection is recommended following unusually high winds (such as a thunderstorm with wind speeds of 70 mph peak gust or greater). The purpose of the inspection is to assess whether the storm caused damage that needs to be repaired to maintain building strength and integrity. In addition to inspecting for obvious signs of damage, the inspector should determine if cracks or other openings have developed that may allow water infiltration, which could lead to corrosion or dry rot of concealed components.

4.3.1.5 Site and General Design Considerations in Hurricane-Prone Regions

Via ASCE 7, the 2006 edition of the IBC has only one special wind-related provision pertaining to hospitals in hurricane-prone regions. It pertains to glazing protection within wind-borne debris regions (as defined in ASCE 7). This single additional requirement does not provide adequate protection for occupants of a hospital during a hurricane, nor does it ensure a hospital will remain functional during and after a hurricane. A hospital may comply with IBC but still remain vulnerable to water and missile penetration through the roof or walls. To provide occupant protection, the exterior walls and the roof must be designed and constructed to resist wind-borne debris as discussed in Sections 4.3.2.1, 4.3.3.2, 4.3.3.4, 4.3.3.6, and 4.3.3.8. The following recommendations are made regarding siting:

- Locate poles, towers, and trees with trunks larger than 6 inches in diameter away from primary site access roads so that they do not block access to, or hit, the facility if toppled.
- Determine if existing buildings within 1,500 feet of the new facility have aggregate surfaced roofs. If roofs with aggregate surfacing are present, it is recommended that the aggregate be removed to prevent it from striking the new facility. Aggregate removal may necessitate reroofing or other remedial work in order to maintain the roof's fire or wind resistance.
- In cases where multiple buildings are occupied during a storm, it is recommended that enclosed walkways be designed to connect the buildings. The enclosed walkways (above- or below-grade) are particularly important for protecting people moving between buildings during a hurricane (e.g., to retrieve equipment or supplies) or for situations when it is necessary to evacuate occupants from one building to another during a hurricane (see Figure 4-27).



Figure 4-27:
Open walkways do not provide protection from wind-borne debris. (Hurricane Katrina, Mississippi)

4.3.2 STRUCTURAL SYSTEMS

Based on post-storm damage evaluations, with the exception of strong and violent tornado events, the structural systems (i.e., MWFRS and structural components such as roof decking) of hospitals have typically performed quite well during design wind events. There have, however, been notable exceptions; in these cases, the most common problem has been blow-off of the roof deck, but instances of collapse have also been documented (Figure 4-34). The structural problems have primarily been caused by lack of an adequate load path, with connection failure being a common occurrence. Problems have also been caused by workmanship errors (commonly associated with steel decks attached by puddle welds), and limited uplift resistance of deck connections in roof perimeters and corners (due to lack of code-required enhancement in older editions of the model codes).

With the exception of strong and violent tornado events, structural systems designed and constructed in accordance with the IBC should typically offer adequate wind resistance, provided attention was given to load path continuity and to the durability of building materials (with respect to corrosion and termites). However, the greatest reliability is offered by cast-in-place concrete. There are no known reports of any cast-in-place concrete buildings experiencing a significant structural problem during wind events, including the strongest hurricanes (Category 5) and tornadoes (F5).

The following design parameters are recommended for structural systems:

- If a pre-engineered metal building is being contemplated, special steps should be taken to ensure the structure has more redundancy than

is typically the case with pre-engineered buildings.⁸ Steps should be taken to ensure the structure is not vulnerable to progressive collapse in the event a primary bent (steel moment frame) is compromised or bracing components fail.

- Exterior load-bearing walls of masonry or precast concrete should be designed to have sufficient strength to resist external and internal loading when analyzed as C&C. CMU walls should have vertical and horizontal reinforcing and grout to resist wind loads. The connections of precast concrete wall panels should be designed to have sufficient strength to resist wind loads.
- For roof decks, concrete, steel, plywood, or oriented strand board (OSB) is recommended.
- For steel roof decks, it is recommended that a screw attachment be specified, rather than puddle welds or powder-driven pins. Screws are more reliable and much less susceptible to workmanship problems. Figure 4-28 shows decking that was attached with puddle welds. At most of the welds, there was only superficial bonding of the metal deck to the joist, as illustrated by this example. Only a small portion of the deck near the center of the weld area (as delineated by the circle) was well fused to the joist. Figures 4-29 and 4-30 show problems with acoustical decking attached with powder-driven pins. The pin shown on the left of Figure 4-30 is properly seated. However, the pin at the right did not penetrate far enough into the steel joist below.

Figure 4-28:

View looking down at the top of a steel joist after the metal decking blew away. Only a small portion of the deck was well fused to the joist (circled area). Tornado (Oklahoma, 1999)

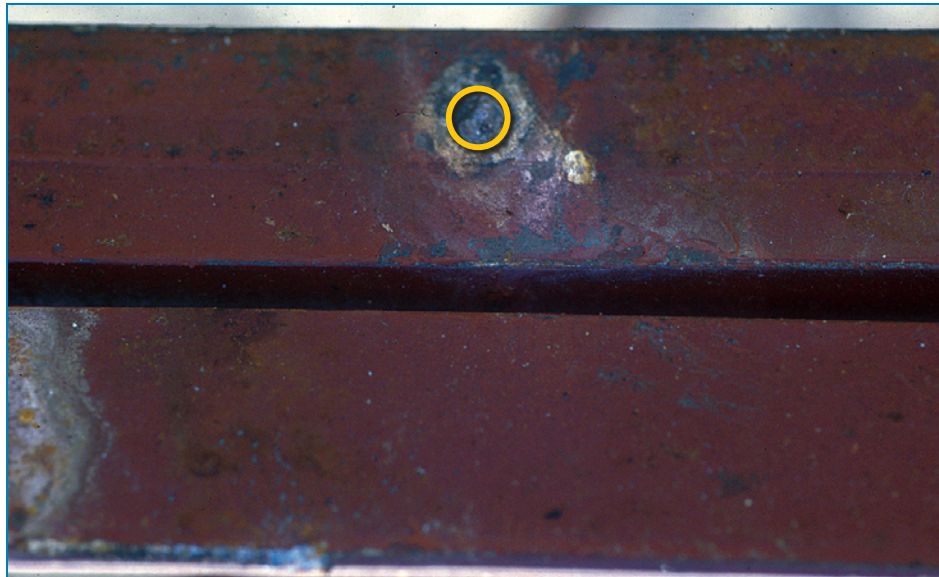

⁸ The structural system of pre-engineered metal buildings is composed of rigid steel frames, secondary members (including roof purlins and wall girts made of Z- or C-shaped members) and bracing.

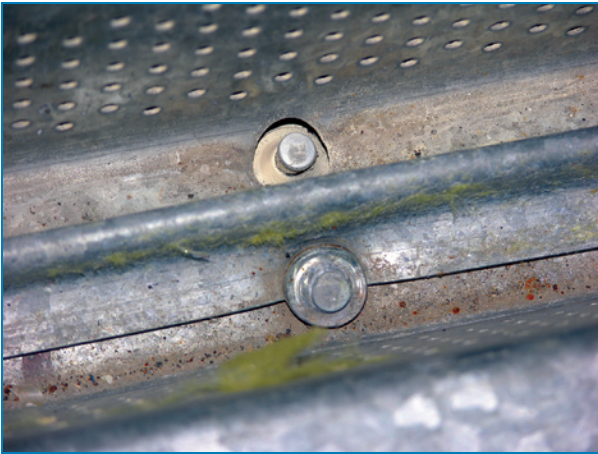

Figure 4-29:
Looking down at a sidelap of a deck attached with powder-driven pins. The washer at the top pin blew through the deck.



Figure 4-30:
View looking along a sidelap of a deck attached with powder-driven pins. The right pin does not provide adequate uplift and shear resistance.

- For attaching wood-sheathed roof decks, screws, ring-shank, or screw-shank nails are recommended in the corner regions of the roof. Where the basic wind speed is greater than 90 mph, these types of fasteners are also recommended for the perimeter regions of the roof.
- For precast concrete decks it is recommended that the deck connections be designed to resist the design uplift loads because the deck dead load itself is often insufficient to resist the uplift. The deck in Figure 4-31 had bolts to provide uplift resistance; however, anchor plates and nuts had not been installed. Without the anchor plates, the dead load of the deck was insufficient to resist the wind uplift load.



Figure 4-31:
Portions of this waffled precast concrete roof deck were blown off. Typhoon Paka (Guam, 1997)

- For precast Tee decks, it is recommended that the reinforcing be designed to accommodate the uplift loads in addition to the gravity loads. Otherwise, large uplift forces can cause member failure due to the Tee's own pre-stress forces after the uplift load exceeds the dead load of the Tee. This type of failure occurred at one of the roof panels shown in Figure 4-32, where a panel lifted because of the combined effects of wind uplift and pre-tension. Also, because the connections between the roof and wall panels provided very little uplift load resistance, several other roof and wall panels collapsed.

Figure 4-32:
Twin-Tee roof panel lifted as a result of the combined effects of wind uplift and pre-tension. Tornado (Missouri, May 2003)



- For buildings that have mechanically attached single-ply or modified bitumen membranes, designers should refer to the decking recommendations presented in the *Wind Design Guide for Mechanically Attached Flexible Membrane Roofs*, B1049 (National Research Council of Canada, 2005).

ASCE 7-05 provides pressure coefficients for open canopies of various slopes (referred to as “free roofs” in ASCE 7). The free roof figures for MWFRS in ASCE 7-05 (Figures 6-18A to 6-18D) include two load cases, Case A and Case B. While there is no discussion describing the two load cases, they pertain to fluctuating loads and are intended to represent upper and lower limits of instantaneous wind pressures. Loads for both cases must be calculated to determine the critical loads. Figures 6-18A to 6-18C are for a wind direction normal to the ridge. For wind direction parallel to the ridge, use Figure 6-18D in ASCE 7-05.

- If an FMG-rated roof assembly is specified, the roof deck also needs to comply with the FMG criteria.

- Walkway and entrance canopies are often damaged during high winds (see Figure 4-33). Wind-borne debris from damaged canopies can damage nearby buildings and injure people, hence these elements should also receive design and construction attention.



Figure 4-33:
The destroyed walkway canopy in front of this building became wind-borne debris. Hurricane Ivan (Florida, 2004)

4.3.2.1 Structural Systems in Hurricane-Prone Regions

Because of the exceptionally good wind performance and wind-borne debris resistance that reinforced cast-in-place concrete structures offer, a reinforced concrete roof deck and reinforced concrete or reinforced and fully grouted CMU exterior walls are recommended as follows:

Roof deck: A minimum 4-inch-thick, cast-in-place reinforced concrete deck is the preferred deck. Other recommended decks are minimum 4-inch-thick structural concrete topping over steel decking, and precast concrete with an additional minimum 4-inch structural concrete topping.

If precast concrete is used for the roof or wall structure, the connections should be carefully designed, detailed, and constructed.

If these recommendations are not followed for hospitals located in areas where the basic wind speed is 100 mph or greater, it is recommended that the roof assembly be able to resist complete penetration of the deck by the “D” missile specified in ASTM E 1996 (2005) (see text box in Section 4.3.3.2).

Exterior load-bearing walls: A minimum 6-inch-thick, cast-in-place concrete wall reinforced with #4 rebars at 12 inches on center each way is the preferred wall. Other recommended walls are a minimum 8-inch-thick fully grouted CMU reinforced vertically with #4 rebars at 16 inches on center, and precast concrete that is a minimum 6-inches-thick and reinforced equivalent to the recommendations for cast-in-place walls.

4.3.3 BUILDING ENVELOPE

The following section highlights the design considerations for building envelope components that have historically sustained the greatest and most frequent damage in high winds.

The design considerations for building envelope components of hospitals in hurricane-prone regions include a number of additional recommendations. The principal concern that must be addressed is the additional risk from wind-borne debris and water leakage. Design considerations specific to hurricane-prone regions are discussed in Sections 4.3.3.2, 4.3.3.4, 4.3.3.6, and 4.3.3.8.

4.3.3.1 Exterior Doors

This section addresses primary and secondary egress doors, sectional (garage) doors, and rolling doors. Although blow-off of personnel doors is uncommon, it can cause serious problems (see Figure 4-34). Blown-off doors allow entrance of rain, and tumbling doors can damage buildings and cause injuries.

For further general information on doors, see “Fenestration Systems” in the National Institute of Building Sciences’ Building Envelope Design Guide (www.wbdg.org/design/envelope.php).

Blown off sectional and rolling doors are quite common. These failures are typically caused by the use of door and track assemblies that have

insufficient wind resistance, or by inadequate attachment of the tracks or nailers to the wall (see Figure 4-35).

Figure 4-34:
Door on a hospital penthouse blown off its hinges during Hurricane Katrina (Mississippi, 2005)

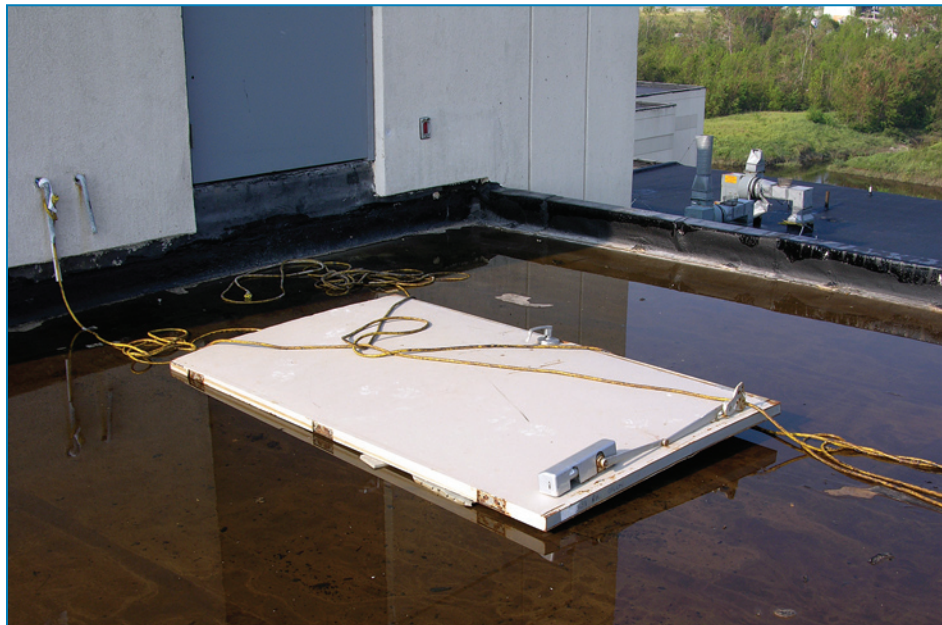



Figure 4-35:
This new rolling door failed because the CMU spalled at the door frame's expansion bolts, which were too close to the end of the CMU. Hurricane Charley (Florida, 2004)

Loads and Resistance

The IBC requires that the door assembly (i.e., door, hardware, frame, and frame attachment to the wall) be of sufficient strength to resist the positive and negative design wind pressure. Design professionals should require that doors comply with wind load testing in accordance with ASTM E 1233. Design professionals should also specify the attachment of the door frame to the wall (e.g., type, size, spacing, and edge distance of frame fasteners). For sectional and rolling doors attached to wood nailers, design professionals should also specify the attachment of the nailer to the wall.

For design guidance on attachment of door frames, see Technical Data Sheet #161, *Connecting Garage Door Jambs to Building Framing*, published by the Door & Access Systems Manufacturers Association, 2003 (available at www.dasma.com).

Water Infiltration

Heavy rain that accompanies high winds (e.g., thunderstorms, tropical storms, and hurricanes) can cause significant wind-driven water infiltration problems. The magnitude of the problem increases with the wind speed. Leakage can occur between the door and its frame, the frame and the wall, and between the threshold and the door. When wind speeds approach 120 mph, some leakage should be anticipated because of the very high wind pressures and numerous opportunities for leakage path development.

Where corrosion is problematic, anodized aluminum or galvanized doors and frames, and stainless steel frame anchors and hardware are recommended.

The following recommendations should be considered to minimize infiltration around exterior doors.

Vestibule: Adding a vestibule allows both the inner and outer doors to be equipped with weatherstripping. The vestibule can be designed with water-resistant finishes (e.g., concrete or tile) and the floor can be equipped with a drain. In addition, installing exterior threshold trench drains can be helpful (openings must be small enough to avoid trapping high-heeled shoes). Note that trench drains do not eliminate the problem, since water can still penetrate at door edges.

For primary swinging entry/exit doors, exit door hardware is recommended to minimize the possibility of the doors being pulled open by wind suction. Exit hardware with top and bottom rods is more secure than exit hardware that latches at the jamb.

Door swing: Out-swinging doors have weatherstripping on the interior side of the door, where it is less susceptible to degradation, which is an advantage when compared to in-swinging doors. Some interlocking weatherstripping assemblies are available for out-swinging doors.

The successful integration of the door frame and the wall is a special challenge when designing doors. See Section 4.3.3.3 for discussion of this juncture.

ASTM E 2112 provides information pertaining to the installation of doors, including the use of sill pan flashings with end dams and rear legs (see Figure 4-36). It is recommended that designers use ASTM E 2112 as a design resource.

Figure 4-36:
Door sill pan flashing with end dams, rear leg, and turned-down front leg

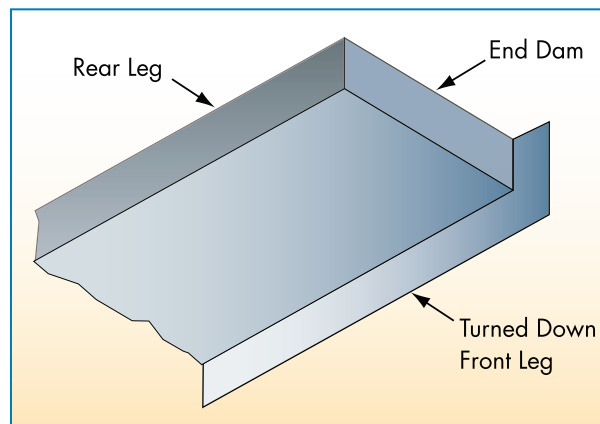

Weatherstripping

A variety of pre-manufactured weatherstripping components is available, including drips, door shoes and bottoms, thresholds, and jamb/head weatherstripping.

Drips: These are intended to shed water away from the opening between the frame and the door head, and the opening between the door bottom and the threshold (see Figures 4-37 and 4-38). Alternatively, a door sweep can be specified (see Figure 4-38). For high-traffic doors, periodic replacement of the neoprene components will be necessary.

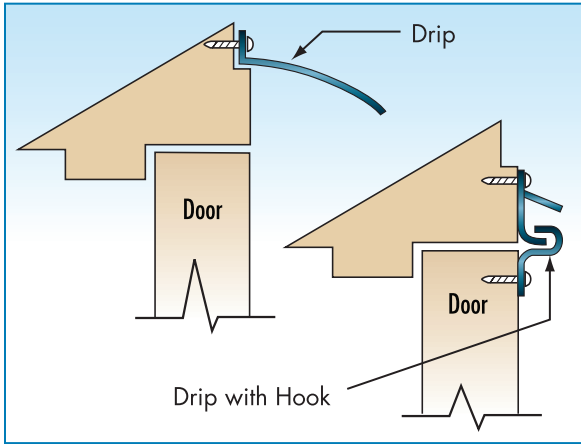

Figure 4-37:
Drip at door head and drip with hook at head

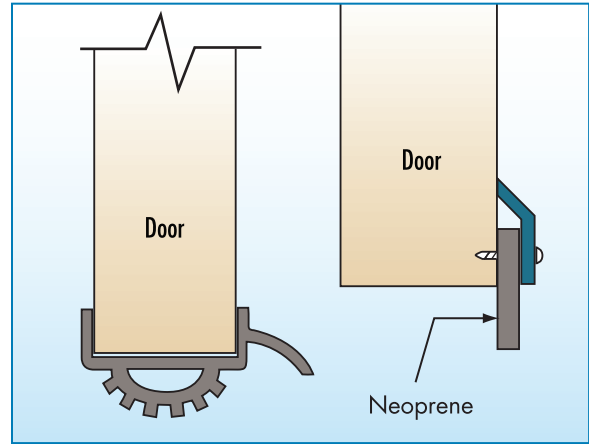

Figure 4-38:
Door shoe with drip and vinyl seal (left).
Neoprene door bottom sweep (right)

Door shoes and bottoms: These are intended to minimize the gap between the door and the threshold. Figure 4-38 illustrates a door shoe that incorporates a drip. Figure 4-39 illustrates an automatic door bottom. Door bottoms can be surface-mounted or mortised. For high-traffic doors, periodic replacement of the neoprene components will be necessary.

Thresholds: These are available to suit a variety of conditions. Thresholds with high (e.g., 1-inch) vertical offsets offer enhanced resistance to wind-driven water infiltration. However, the offset is limited where the thresholds are required to comply with the Americans with Disabilities Act (ADA), or at high-traffic doors. At other doors, high offsets are preferred.

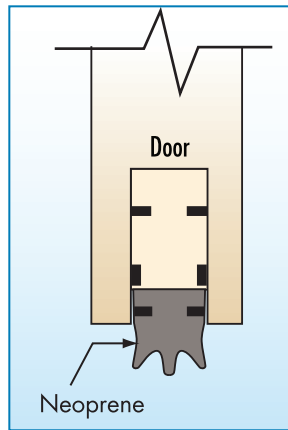

Figure 4-39:
Automatic door bottom

Thresholds can be interlocked with the door (see Figure 4-40), or thresholds can have a stop and seal (see Figure 4-41). In some instances, the threshold is set directly on the floor. Where this is appropriate, setting the threshold in butyl sealant is recommended to avoid water infiltration between the threshold and the floor. In other instances, the threshold is set on a pan flashing (as previously discussed in this section). If the threshold has weep holes, specify that the weep holes not be obstructed during construction (see Figure 4-40).

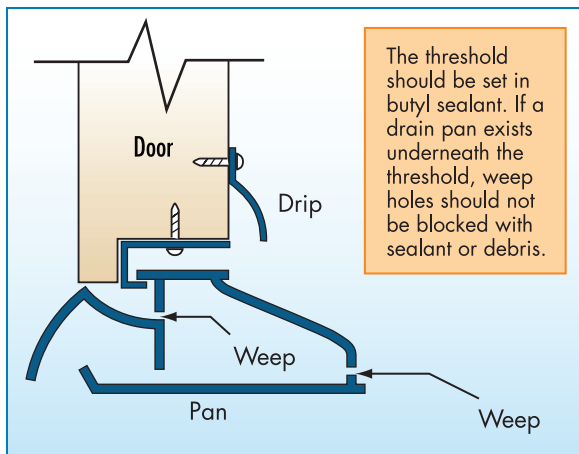

Figure 4-40: Interlocking threshold with drain pan

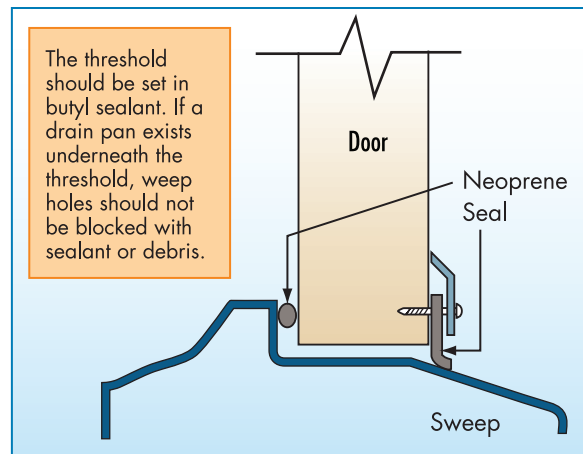
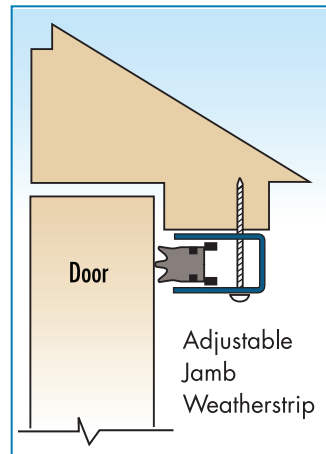

Figure 4-41: Threshold with stop and seal

Figure 4-42:
Adjustable jamb/head weatherstripping



Adjustable jamb/head weatherstripping: This type of weatherstripping is recommended because the wide sponge neoprene offers good contact with the door (see Figure 4-42). The adjustment feature also helps to ensure good contact, provided the proper adjustment is maintained.

Meeting stile: At the meeting stile of pairs of doors, an overlapping astragal weatherstripping offers greater protection than weatherstripping that does not overlap.

4.3.3.2 Exterior Doors in Hurricane-Prone Regions

Although the ASCE-7 wind-borne debris provisions only apply to glazing within a portion of hurricane-prone regions, it is recommended that all hospitals located where the basic wind speed is 100 mph or greater comply with the following recommendations:

- To minimize the potential for missiles penetrating exterior doors and striking people inside the facility, it is recommended that doors (with and without glazing) be designed to resist the “E” missile load specified in ASTM E 1996. The doors should be tested in accordance with ASTM E 1886 (2005). The test assembly should include the door, door frame, and hardware.

ASTM E 1996 specifies five missile categories, A through E. The missiles are of various weights and fired at various velocities during testing. Building type (critical or non-critical) and basic wind speed determine the missiles required for testing. Of the five missiles, the E missile has the greatest momentum. Missile E is required for critical facilities located where the basic wind speed is greater than or equal to 130 mph. Missile D is permitted where the basic wind speed is less than 130 mph. FEMA 361 also specifies a missile for shelters. The shelter missile has much greater momentum than the D and E missiles, as shown below:

Missile	Missile Weight	Impact Speed	Momentum
ASTM E 1996–D	9 pound 2x4 lumber	50 feet per second (34 mph)	14 lb _f -s*
ASTM E 1996–E	9 pound 2x4 lumber	80 feet per second (55 mph)	22 lb _f -s*
FEMA 361 (Shelter Missile)	15 pound 2x4 lumber	147 feet per second (100 mph)	68 lb _f -s*

* lb_f-s = pounds force per second

4.3.3.3 Windows and Skylights

This section addresses general design considerations for exterior windows and skylights. For additional information on windows and skylights located in hurricane-prone regions, see Section 4.3.3.4, and for those in tornado-prone regions, see Section 4.5.

For further general information on windows, see the National Institute of Building Sciences' *Building Envelope Design Guide* (www.wbdg.org/design/envelope.php).

Loads and Resistance

The IBC requires that windows, curtain walls, and skylight assemblies (i.e., the glazing, frame, and frame attachment to the wall or roof) have sufficient strength to resist the positive and negative design wind pressure (see Figure 4-43). Design professionals should specify that these assemblies comply with wind load testing in accordance with ASTM E 1233. It is important to specify an adequate load path and to check its continuity during submittal review.

Where water infiltration protection is particularly demanding and important, it is recommended that onsite water infiltration testing in accordance with ASTM E 1105 be specified.

Figure 4-43:
Two complete windows, including frames, blew out as a result of an inadequate number of fasteners. Typhoon Paka (Guam, 1997)



Water Infiltration

Heavy rain accompanied by high winds can cause wind-driven water infiltration problems. The magnitude of the problem increases with the wind speed. Leakage can occur at the glazing/frame interface, the frame itself, or between the frame and wall. When the basic wind speed is greater than 120 mph, because of the very high design wind pressures and numerous opportunities for leakage path development, some leakage should be anticipated when the design wind speed conditions are approached.

The successful integration of windows and curtain walls into exterior walls is a challenge in protecting against water infiltration. To the extent possible when detailing the interface between the wall and the window or curtain wall units, designers should rely on sealants as the secondary line of defense against water infiltration, rather than making the sealant the primary protection. If a sealant joint is the first line of defense, a second line of defense should be designed to intercept and drain water that drives past the sealant joint.

The maximum test pressure used in the current ASTM test standard for evaluating resistance of window units to wind-driven rain is well below design wind pressures. Therefore, units that demonstrate adequate wind-driven rain resistance during testing may experience leakage during actual wind events.

When designing joints between walls and windows and curtain wall units, consider the shape of the sealant joint (i.e., a square joint is typically preferred) and the type of sealant to be specified. The sealant joint should be designed to enable the sealant to bond on only two opposing surfaces (i.e., a backer rod or bond-breaker tape should be specified). Butyl is recommended as a sealant for concealed joints, and polyurethane for exposed joints. During

installation, cleanliness of the sealant substrate is important (particularly if polyurethane or silicone sealants are specified), as is the tooling of the sealant. ASTM E 2112 provides guidance on the design of sealant joints, as well as other information pertaining to the installation of windows, including the use of sill pan flashings with end dams and rear legs (see Figure 4-44). Windows that do not have nailing flanges should typically be installed over a pan flashing. It is recommended that designers use ASTM E 2112 as a design resource.

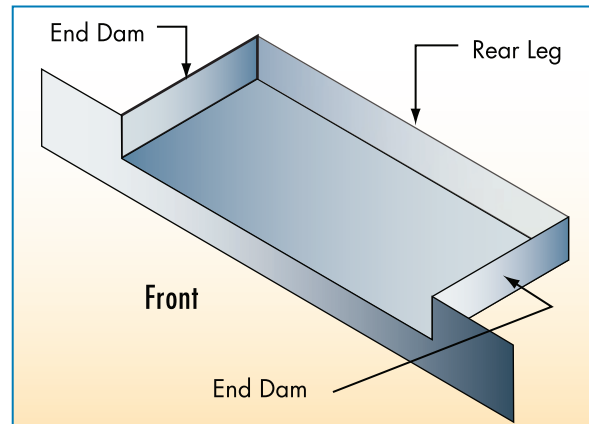

Figure 4-44:
View of a typical window sill pan flashing with end dams and rear legs

SOURCE: ASTM E 2112

Sealant joints can be protected with a removable stop, as illustrated in Figure 4-45. The stop protects the sealant from direct exposure to the weather and reduces the possibility of wind-driven rain penetration.

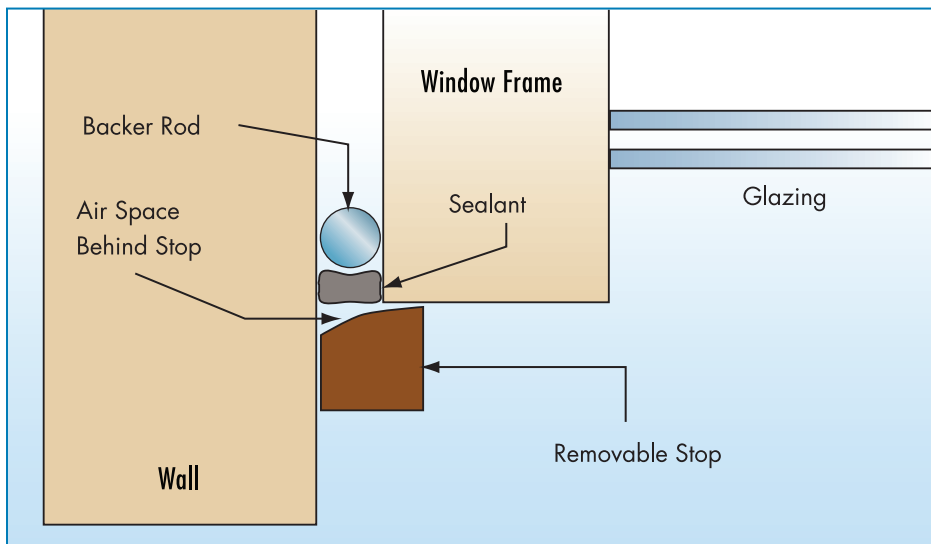

Figure 4-45:
Protecting sealant retards weathering and reduces the exposure to wind-driven rain.

4.3.3.4 Windows and Skylights in Hurricane-Prone Regions

Exterior glazing that is not impact-resistant (such as laminated glass or polycarbonate) or protected by shutters is extremely susceptible to breaking if struck by wind-borne debris. Even small, low-momentum missiles can easily break glazing that is not protected (see Figures 4-46 and 4-47). At the hospital shown in Figure 4-46, approximately 400 windows were broken. Most of the breakage was caused by wind-blown aggregate from the hospital's aggregate ballasted single-ply membrane roofs, and

aggregate from built-up roofs. At the hospital shown in Figure 4-47, several of the skylight's tempered glass outer panes were broken by wind-blown aggregate from the hospital's aggregate ballasted single-ply membrane. The inner laminated glass panes were not broken. Note that some of the copings were also blown off (blue arrow)—some of the glazing may have been damaged by wind-blown copings. At the grey hospital on the other side of the street, much of the roof membrane was blown away (yellow arrow).

With broken windows, a substantial amount of water can be blown into a building, and the internal air pressure can be greatly increased, which may damage the interior partitions and ceilings.

Figure 4-46:
Plywood panels (black continuous bands) installed after the glass spandrel panels were broken by roof aggregate.⁹ Hurricane Katrina (Mississippi, 2005)



Figure 4-47:
The outer glass panes of the skylight were broken by roof aggregate (red arrow). Hurricane Hugo (South Carolina, 1989)

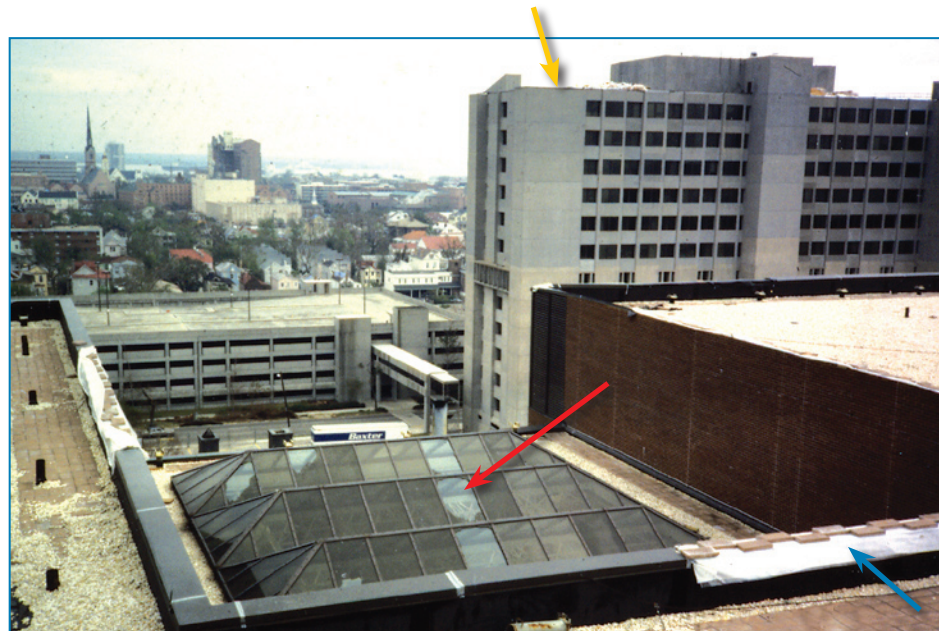

⁹ Glass spandrel panels are opaque glass. They are placed in curtain walls to conceal the area between the ceiling and the floor above.

In order to minimize interior damage, the IBC, through ASCE 7, prescribes that exterior glazing in wind-borne debris regions be impact-resistant, or be protected with an impact-resistant covering (shutters). For Category III and IV buildings in areas with a basic wind speed of 130 mph or greater, the glazing is required to resist a larger momentum test missile than would Category II buildings and Category III and IV buildings in areas with wind speeds of less than 130 mph.

ASCE 7 refers to ASTM E 1996 for missile loads and to ASTM E 1886 for the test method to be used to demonstrate compliance with the E 1996 load criteria. In addition to testing impact resistance, the window unit is subjected to pressure cycling after test missile impact to evaluate whether the window can still resist wind loads. If wind-borne debris glazing protection is provided by shutters, the glazing is still required by ASCE 7 to meet the positive and negative design air pressures.

Although the ASCE 7 wind-borne debris provisions only apply to glazing within a portion of hurricane-prone regions, it is recommended that all hospitals located where the basic wind speed is 100 mph or greater comply with the following recommendations:

- To minimize the potential for missiles penetrating exterior glazing and injuring people, it is recommended that exterior glazing up to 60 feet above grade be designed to resist the test Missile E load specified in ASTM E 1996 (see text box in Section 4.3.3.2). In addition, if roofs with aggregate surfacing are present within 1,500 feet of the facility, glazing above 60 feet should be designed to resist the test Missile A load specified in ASTM E 1996. The height of the protected glazing should extend a minimum of 30 feet above the aggregate surfaced roof per ASCE 7.

Because large missiles are generally flying at lower elevations, glazing that is more than 60 feet above grade and meets the test Missile A load should be sufficient. However, if the facility is within a few hundred feet of another building that may create debris, such as EIFS, tiles, or rooftop equipment, it is recommended that the test Missile E load be specified instead of the Missile A for the upper-level glazing.

- For those facilities where glazing resistant to bomb blasts is desired, the windows and glazed doors can be designed to accommodate wind pressure, missile loads, and blast pressure. However, the window and door units need to be tested for missile loads and cyclic air pressure, as well as for blast. A unit that meets blast criteria will not necessarily meet the E 1996 and E 1886 criteria, and vice versa.

For further information on designing glazing to resist blast, see the “Blast Safety” resource pages of the National Institute of Building Sciences’ *Building Envelope Design Guide* (www.wbdg.org/design/envelope.php).

With the advent of building codes requiring glazing protection in wind-borne debris regions, a variety of shutter designs have entered the market. Shutters typically have a lower initial cost than laminated glass. However, unless the shutter is permanently anchored to the building (e.g., an accordion shutter), storage space will be needed. Also, when a hurricane is forecast, costs will be incurred each time shutters are installed and removed. The cost and difficulty of shutter deployment and demobilization on upper-level glazing may be avoided by using motorized shutters, although laminated glass may be a more economical solution. For further information on shutters, see Section 4.4.2.2.

4.3.3.5 Non-Load-Bearing Walls, Wall Coverings, and Soffits

For further general information on non-load-bearing walls and wall coverings, see the National Institute of Building Sciences' *Building Envelope Design Guide* (www.wbdg.org/design/envelope.php).

This section addresses exterior non-load-bearing walls, exterior wall coverings, and soffits, as well as the underside of elevated floors, and provides guidance for interior non-load-bearing masonry walls. See Section 4.4.3.6 for additional information pertaining to hospitals located in hurricane-prone regions, and

Section 4.5 for additional information pertaining to hospitals located in tornado-prone regions.

Figure 4-48:

The wall covering blew off the penthouse at this hospital complex, allowing rainwater to destroy the elevator controls. Hurricane Ivan (Florida, 2004)



To ensure the continuity of elevator service, elevator penthouse walls must possess adequate wind and water resistance. If the walls blow away or water leaks through the wall system, the elevator controls and/or motors can be destroyed. Loss of elevators may critically affect facility operations (see Figures 4-22 and 4-48). The restoration of elevator service can take weeks, even with expedited work.

Loads and Resistance

The IBC requires that soffits, exterior non-load-bearing walls, and wall coverings have sufficient strength to resist the positive and negative design wind pressures.

Soffits: Depending on the wind direction, soffits can experience either positive or negative pressure. Besides the cost of repairing the damaged soffits, wind-borne soffit debris can cause property damage and injuries (see Figures 4-49 and 4-50). Failed soffits may also provide a convenient path for wind-driven rain to enter the building. Storm-damage research has shown that water blown into attic spaces after the loss of soffits can cause significant damage and the collapse of ceilings. Even in instances where soffits remain in place, water can penetrate through soffit vents and cause damage. At this time, there are no known specific test standards or design guidelines to help design wind- and water-resistant soffits and soffit vents.

Where corrosion is a problem, stainless steel fasteners are recommended for wall and soffit systems. For other components (e.g., furring, blocking, struts, and hangers), nonferrous components (such as wood), stainless steel, or steel with a minimum of G-90 hot-dipped galvanized coating are recommended. Additionally, access panels are recommended so components within soffit cavities can be periodically inspected for corrosion or dry rot.



Figure 4-49: This suspended metal soffit was not designed for upward-acting wind pressure. Typhoon Paka (Guam, 1997)

Figure 4-50:
Hospital canopy
damage. Hurricane
Katrina (Louisiana,
2005)



Exterior non-load-bearing masonry walls: Particular care should be given to the design and construction of exterior non-load-bearing masonry walls. Although these walls are not intended to carry gravity loads, they should be designed to resist the external and internal loading for components and cladding in order to avoid collapse. When these types of walls collapse, they represent a severe risk to life because of their great weight.

Interior non-load-bearing masonry walls: Special consideration should also be given to interior non-load-bearing masonry walls. Although these walls are not required by building codes to be designed to resist wind loads, if the exterior glazing is broken, or the exterior doors are blown away, the interior walls could be subjected to significant load as the building rapidly becomes fully pressurized. To avoid casualties, it is recommended that interior non-load-bearing masonry walls adjacent to occupied areas be designed to accommodate loads exerted by a design wind event, using the partially enclosed pressure coefficient (see Figure 4-51). By doing so, wall collapse may be prevented if the building envelope is breached. This recommendation is applicable to hospitals located in areas with a basic wind speed greater than 120 mph, and to hospitals in tornado-prone regions that do not have shelter space designed in accordance with FEMA 361.



Figure 4-51:
The red arrows show the original location of a CMU wall that nearly collapsed following a rolling door failure. Hurricane Charley (Florida, 2004)

Wall Coverings

There are a variety of exterior wall coverings. Brick veneer, exterior insulation finish systems (EIFS), stucco, metal wall panels, and aluminum and vinyl siding have often exhibited poor wind performance. Veneers (such as ceramic tile and stucco) over concrete, stone veneer, and cement-fiber panels and siding have also blown off. Wood siding and panels rarely blow off. Although tilt-up precast walls have failed during wind storms, precast wall panels attached to steel or concrete framed buildings typically offer excellent wind performance.

Brick veneer:¹⁰ Brick veneer is frequently blown off walls during high winds. When brick veneer fails, wind-driven water can enter and damage buildings, and building occupants can be vulnerable to injury from wind-borne debris (particularly if the walls are sheathed with plastic foam insulation or wood fiberboard in lieu of wood panels). Pedestrians in the vicinity of damaged walls can also be vulnerable to injury from falling bricks (see Figure 4-52). Common failure modes include tie (anchor) fastener pull-out (see Figure 4-53), failure of masons to embed ties into the mortar, poor bonding between ties and mortar, a mortar of poor quality, and tie corrosion.

¹⁰The brick veneer discussion is from *Attachment of Brick Veneer in High-Wind Regions—Hurricane Katrina Recovery Advisory* (FEMA, December 2005).

Figure 4-52:
The brick veneer failure on this building was attributed to tie corrosion. Hurricane Ivan (Florida, 2004)



Figure 4-53:
This tie remained embedded in the mortar joint while the smooth-shank nail pulled from the stud.



Ties are often installed before brick laying begins. When this is done, ties are often improperly placed above or below the mortar joints. When misaligned, the ties must be angled up or down to be embedded into the mortar joints (Figure 4-54). Misalignment not only reduces the embedment depth, but also reduces the effectiveness of the ties, because wind forces do not act in parallel direction to the ties.

Corrugated ties typically used in residential veneer construction provide little resistance to compressive loads induced by positive and negative pressure. The use of compression struts would likely be beneficial, but off-the-shelf devices do not currently exist. Two-piece adjustable ties (Figure 4-55) provide significantly greater compressive strength than corrugated ties.

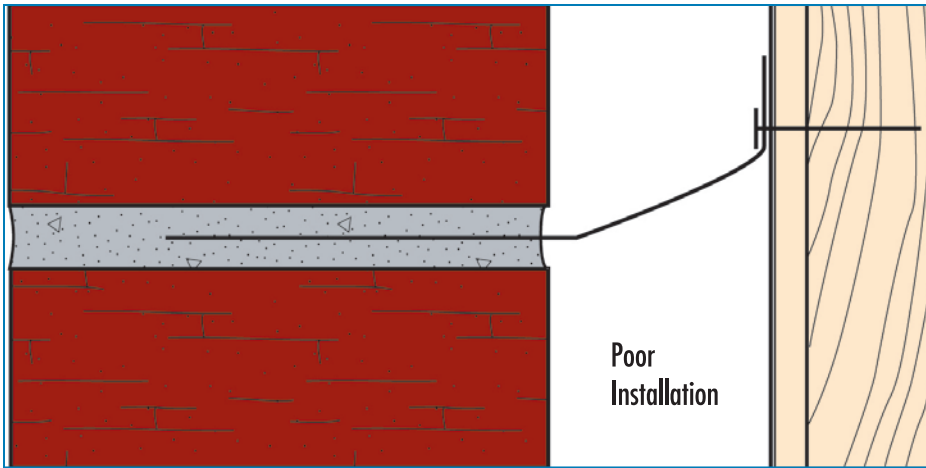

Figure 4-54: Misalignment of the tie reduces the embedment and promotes veneer failure.

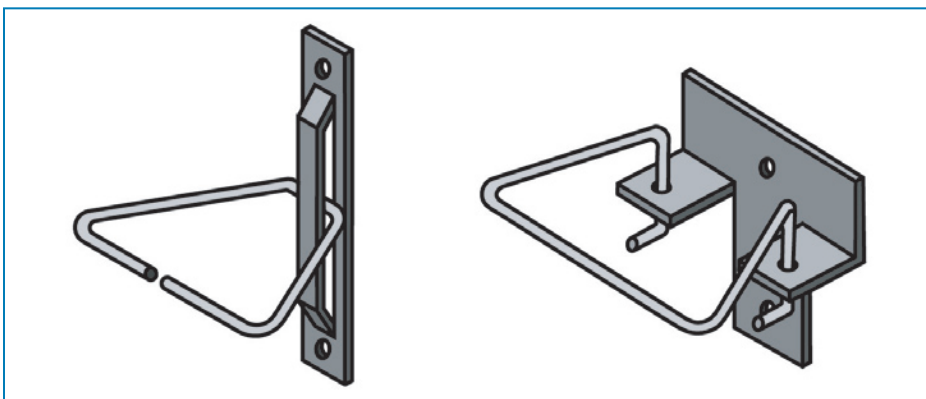

Figure 4-55: Examples of two-piece adjustable ties

The following Brick Industry Association (BIA) technical notes provide guidance on brick veneer: *Technical Notes 28: Anchored Brick Veneer, Wood Frame Construction* (2002); *Technical Notes 28B: Brick Veneer/Steel Stud Walls* (2005); and *Technical Notes 44B: Wall Ties* (2003) (available online at www.bia.org). These technical notes provide attachment recommendations; however, they are not specific for high-wind regions. To enhance wind performance of brick veneer, the following are recommended:

- Calculate wind loads and determine tie spacing in accordance with the latest edition of the Building Code Requirements for Masonry Structures, ACI 530/ASCE 5/TMS 402 (ACI 530, 2005). A stud spacing of 16 inches on center is recommended so that ties can be anchored at this spacing.
- Ring-shank nails are recommended in lieu of smooth-shank nails for wood studs. A minimum embedment of 2 inches is suggested.
- For use with wood studs, two-piece adjustable ties are recommended. However, where corrugated steel ties are used, they should be 22-gauge

minimum, $\frac{7}{8}$ -inch wide by 6-inch long, and comply with ASTM A 1008, with a zinc coating complying with ASTM A 153 Class B2. For ties used with steel studs, see BIA *Technical Notes 28B—Brick Veneer/Steel Stud Walls*. Stainless steel ties should be used for both wood and steel studs in areas within 3,000 feet of the coast.

- Install ties as the brick is laid so that the ties are properly aligned with the mortar joints.
- Locate ties within 8 inches of door and window openings, and within 12 inches of the top of veneer sections.
- Although corrugated ties are not recommended, if they are used, bend the ties at a 90-degree angle at the nail head to minimize tie flexing when the ties cycle between tension and compression loads (Figure 4-56).
- Embed ties in joints so that the mortar completely encapsulates the ties. Embed a minimum of $1\frac{1}{2}$ inches into the bed joint, with a minimum mortar cover of $\frac{5}{8}$ -inch to the outside face of the wall (Figure 4-57).

Figure 4-56:
Bend ties at nail heads

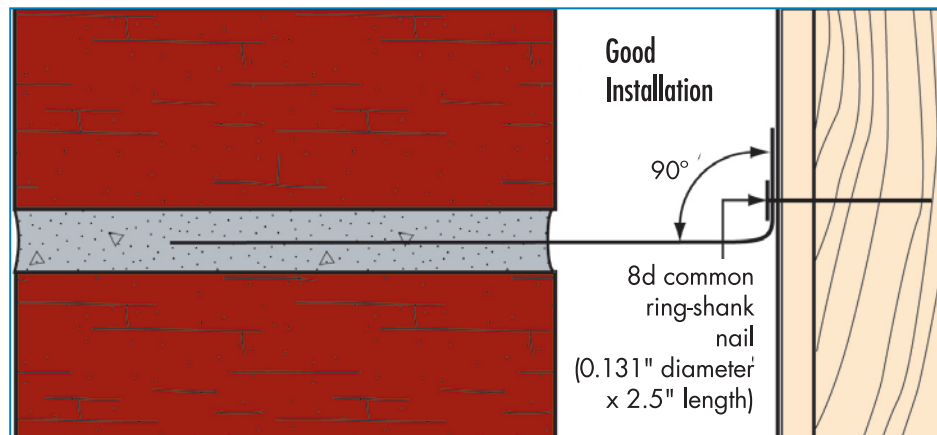
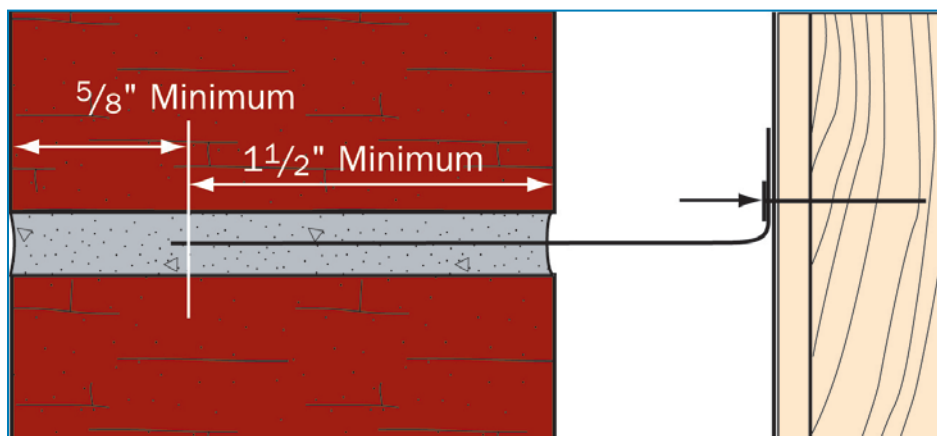

Figure 4-57:
Tie embedment



To avoid water leaking into the building, it is important that weep holes be adequately spaced and not be blocked during brick installation, and that through-wall flashings be properly designed and installed. When the base of the brick veneer occurs near grade, the grade should be designed so that it occurs several inches below the weeps so that drainage from the weeps is not impeded. Also, landscaping should be kept clear of weeps so that vegetation growth does not cause blockage of weeps. At the hospital shown in Figure 4-58, water leaked into the building along the base of many of the brick veneer walls. When high winds accompany heavy rain, a substantial amount of water can be blown into the wall cavity.



Figure 4-58: Water leaked inside along the base of the brick veneer walls (red arrow). Hurricane Katrina (Louisiana, 2005)

EIFS: Figure 4-59 shows typical EIFS assemblies. Figure 4-48 and several figures in Section 4.2.1.3 show EIFS blow-off. In these cases, the molded expanded polystyrene (MEPS) was attached to gypsum board, which in turn was attached to metal studs or hat channels. The gypsum board detached from the studs/hat channels, which is a common EIFS failure mode. When the gypsum board on the exterior side of the studs is blown away, it is common for gypsum board on the interior side to also be blown off. The opening allows the building to become fully pressurized and allows the entrance of wind-driven rain. Other common types of failure include wall framing failure, separation of the MEPS from its substrate, and separation of the synthetic stucco from the MEPS.

At the hospital shown in Figure 4-60, the EIFS was applied over a concrete wall. The MEPS debonded from the concrete. In general, a concrete substrate prevents wind and water from entering a building, but if the EIFS debonds from the concrete, EIFS debris can break unprotected glazing. Glazing damage can be very devastating, as shown and discussed in Section 4.2.1.3.

Figure 4-59:
Typical EIFS
assemblies

Option A

Steel or Wood Framing

EIFS may be attached by mechanical fasteners (as shown) or by adhesive (as shown below)

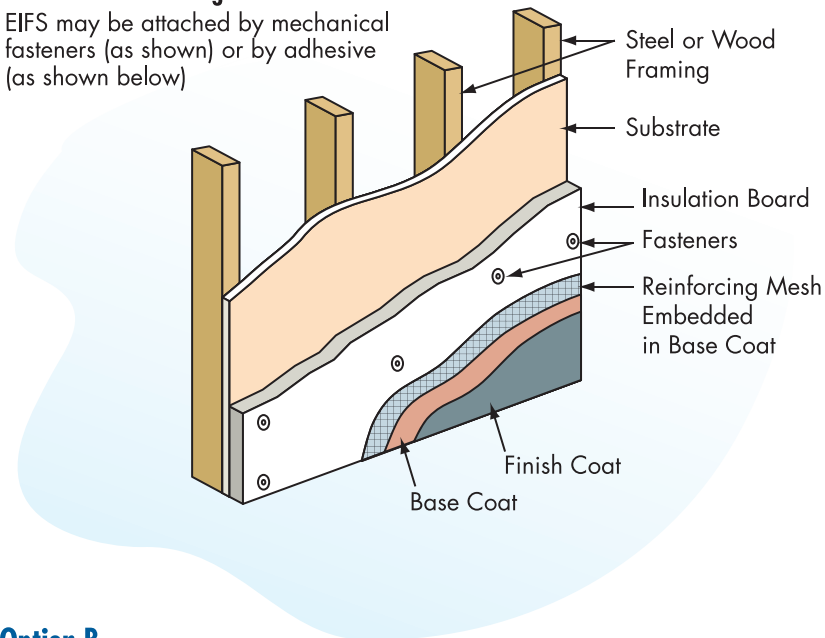

Option B

Concrete or Masonry

EIFS attached to concrete or masonry using adhesive. Mechanical fasteners may also be used.

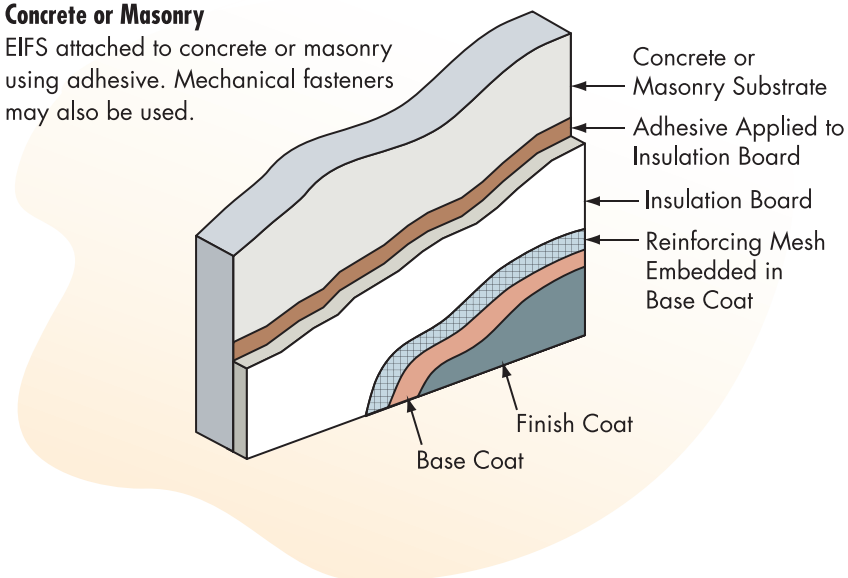



Figure 4-60: EIFS blown off a cast-in-place concrete wall. Note the damaged rooftop ductwork. Hurricane Ivan (Florida, 2004)

Reliable wind performance of EIFS is very demanding on the designer and installer, as well as the maintenance of EIFS and associated sealant joints in order to minimize the reduction of EIFS' wind resistance due to water infiltration. It is strongly recommended that EIFS be designed with a drainage system that allows for the dissipation of water leaks. For further information on EIFS performance during high winds and design guidance, see FEMA 489 and 549.

Another issue associated with EIFS is the potential for judgment errors. EIFS applied over studs is sometimes mistaken for a concrete wall, which may lead people to seek shelter behind it. However, instead of being protected by several inches of concrete, only two layers of gypsum board (i.e., one layer on each side of the studs) and a layer of MEPS separate the occupants from the impact of wind-borne debris that can easily penetrate such a wall and cause injury.

Stucco over studs: Wind performance of traditional stucco walls is similar to the performance of EIFS, as shown in Figure 4-61. In several areas the metal stud system failed; in other areas the gypsum sheathing blew off the studs; and in other areas, the metal lath blew off the gypsum sheathing. The failure shown in Figure 4-61 illustrates the importance of designing and constructing wall framing (including attachment of stud tracks to the building and attachment of the studs to the tracks) to resist the design wind loads.

Figure 4-61:
The stucco wall failure was caused by inadequate attachment between the stud tracks and the building's structure. Hurricane Ivan (Florida, 2004)



Metal wall panels: Wind performance of metal wall panels is highly variable. Performance depends on the strength of the specified panel (which is a function of material and thickness, panel profile, panel width, and whether the panel is a composite) and the adequacy of the attachment (which can be by either concealed clips or exposed fasteners). Excessive spacing between clips/fasteners is the most common problem. Clip/fastener spacing should be specified, along with the specific type and size of fastener. Figure 4-62 illustrates metal wall panel problems. At this building, the metal panels were attached with concealed fasteners. The panels unlatched at the standing seams. In addition to generating wind-borne debris, loss of panels allowed wind-driven rain to enter the building. Water entry was facilitated by lack of a moisture barrier and solid sheathing behind the metal panels (as discussed below).

To minimize water infiltration at metal wall panel joints, it is recommended that sealant tape be specified at sidelaps when the basic wind speed is in excess of 90 mph. However, endlaps should be left unsealed so that moisture behind the panels can be wicked away. endlaps should be a minimum of 3 inches (4 inches where the basic wind speed is greater than 120 mph) to avoid wind-driven rain infiltration. At the base of the wall, a 3-inch (4-inch) flashing should also be detailed, or the panels should be detailed to overlap with the slab or other components by a minimum of 3 inches (4 inches).



Figure 4-62:
The loss of metal wall panels allowed a substantial amount of wind-driven rain to penetrate this building. Hurricane Ivan (Florida, 2004)

Vinyl siding: Vinyl siding blow-off is typically caused by nails spaced too far apart and/or the use of vinyl siding that has inadequate wind resistance. Vinyl siding is available with enhanced wind resistance features, such as an enhanced nailing hem, greater interlocking area, and greater thickness.

Secondary line of protection: Almost all wall coverings permit the passage of some water past the exterior surface of the covering, particularly when the rain is wind-driven. For this reason, most wall coverings should be considered water-shedding, rather than waterproofing coverings. To avoid moisture-related problems, it is recommended that a secondary line of protection with a moisture barrier (such as housewrap or asphalt-saturated felt) and flashings around door and window openings be provided. Designers should specify that horizontal laps of the moisture barrier be installed so that water is allowed to drain from the wall (i.e., the top sheet should lap over the bottom sheet so that water running down the sheets remains on their outer surface). The bottom of the moisture barrier needs to be designed to allow drainage. Had the metal wall panels shown in Figure 4-62 been applied over a moisture barrier and sheathing, the amount of water entering the building would have likely been eliminated or greatly reduced.

The Vinyl Siding Institute (VSI) sponsors a Certified Installer Program that recognizes individuals with at least 1 year of experience who can demonstrate proper vinyl siding application. If vinyl siding is specified, design professionals should consider specifying that the siding contractor be a VSI-certified installer. For further information on this program, see www.vinylsiding.org.

In areas that experience frequent wind-driven rain, incorporating a rain screen design, by installing vertical furring strips between the moisture barrier and siding materials, will facilitate drainage of water from the

space between the moisture barrier and backside of the siding. In areas that frequently experience strong winds, enhanced flashing is recommended. Enhancements include use of flashings that have extra-long flanges, and the use of sealant and tapes. Flashing design should recognize that wind-driven water could be pushed up vertically. The height to which water can be pushed increases with wind speed. Water can also migrate vertically and horizontally by capillary action between layers of materials (e.g., between a flashing flange and housewrap). Use of a rain screen design, in conjunction with enhanced flashing design, is recommended in areas that frequently experience wind-driven rain or strong winds. It is recommended that designers attempt to determine what type of flashing details have successfully been used in the area where the facility will be constructed.

Underside of Elevated Floors

If sheathing is applied to the underside of joists or trusses elevated on piles (e.g., to protect insulation installed between the joists/trusses), its attachment should be specified in order to avoid blow-off. Stainless steel or hot-dip galvanized nails or screws are recommended. Since ASCE 7 does not provide guidance for load determination, professional judgment in specifying attachment is needed.

4.3.3.6 Non-Load-Bearing Walls, Wall Coverings, and Soffits in Hurricane-Prone Regions

In order to achieve enhanced missile resistance of non-load-bearing exterior walls, the wall types discussed in Section 4.3.2.1 (i.e., reinforced concrete, or reinforced and fully grouted CMU) are recommended.

To minimize long-term problems with exterior wall coverings and soffits, it is recommended that they be avoided to the maximum extent possible. Exposed or painted reinforced concrete or CMU offers greater reliability (i.e., they have no coverings that can blow off and become wind-borne debris).

For all hospitals located where the basic wind speed is 100 mph or greater that are not constructed using reinforced concrete or reinforced and fully grouted CMU (as is recommended in this manual), it is recommended that the wall system selected be sufficient to resist complete penetration of the wall by the “E” missile specified in ASTM E 1996.

For interior non-load-bearing masonry walls in hospitals located where the basic wind speed is greater than 120 mph, see the recommendations given in Section 4.3.3.5.

4.3.3.7 Roof Systems

Because roof covering damage has historically been the most frequent and the costliest type of wind damage, special attention needs to be given to roof system design. See Section 4.3.3.8 for additional information pertaining to hospitals located in hurricane-prone regions, and Section 4.5 for hospitals located in tornado-prone regions.

For further general information on roof systems, see the National Institute of Building Sciences' *Building Envelope Design Guide* (www.wbdg.org/design/envelope.php).

Code Requirements

The IBC requires the load resistance of the roof assembly to be evaluated by one of the test methods listed in IBC's Chapter 15. Design professionals are cautioned that designs that deviate from the tested assembly (either with material substitutions or change in thickness or arrangement) may adversely affect the wind performance of the assembly. The IBC does not specify a minimum safety factor. However, for the roof system, a safety factor of 2 is recommended. To apply the safety factor, divide the test load by 2 to determine the allowable design load. Conversely, multiply the design load by 2 to determine the minimum required test resistance.

For structural metal panel systems, the IBC requires test methods UL 580 or ASTM E 1592. It is recommended that design professionals specify use of E 1592, because it gives a better representation of the system's uplift performance capability.

The roof of the elevator penthouse must possess adequate wind and water resistance to ensure continuity of elevator service. It is recommended that a secondary roof membrane, as discussed in Section 4.3.3.8, be specified over the elevator penthouse roof deck.

Load Resistance

Specifying the load resistance is commonly done by specifying a Factory Mutual Research (FMR) rating, such as FM 1-75. The first number (1) indicates that the roof assembly passed the FMR tests for a Class 1 fire rating. The second number (75) indicates the uplift resistance in pounds per square foot (psf) that the assembly achieved during testing. With a safety factor of two this assembly would be suitable for a maximum design uplift load of 37.5 psf.

The highest uplift load occurs at the roof corners because of building aerodynamics as discussed in Section 4.1.3. The perimeter has a somewhat lower load, while the field of the roof has the lowest load. FMG Property Loss Prevention Data Sheets are formatted so that a roof assembly can be selected for the field of the roof. For the perimeter and corner areas, FMG Data Sheet 1-29 provides three options: 1) use the FMG *Approval Guide* listing if it includes a perimeter and corner fastening method; 2) use a

roof system with the appropriate FMG Approval rating in the field, perimeter, and corner, in accordance with Table 1 in FMG Data Sheet 1-29; or 3) use prescriptive recommendations given in FMG Data Sheet 1-29.

When perimeter and corner uplift resistance values are based on a prescriptive method rather than testing, the field assembly is adjusted to meet the higher loads in the perimeter and corners by increasing the number of fasteners or decreasing the spacing of adhesive ribbons by a required amount. However, this assumes that the failure is the result of the fastener pulling out from the deck, or that the failure is in the vicinity of the fastener plate, which may not be the case. Also, the in-

FM Global (FMG) is the name of the Factory Mutual Insurance Company and its affiliates. One of FMG's affiliates, Factory Mutual Research (FMR) provides testing services, produces documents that can be used by designers and contractors, and develops test standards for construction products and systems. FMR evaluates roofing materials and systems for resistance to fire, wind, hail, water, foot traffic and corrosion. Roof assemblies and components are evaluated to establish acceptable levels of performance. Some documents and activities are under the auspices of FMG and others are under FMR.

creased number of fasteners required by FMG may not be sufficient to comply with the perimeter and corner loads derived from the building code. Therefore, if FMG resistance data are specified, it is prudent for the design professional to specify the resistance for each zone of the roof separately. Using the example cited above, if the field of the roof is specified as 1-75, the perimeter would be specified as 1-130 and the corner would be specified as 1-190.

If the roof system is fully adhered, it is not possible to increase the uplift resistance in the perimeter and corners. Therefore, for fully adhered systems, the uplift resistance requirement should be based on the corner load rather than the field load.

Roof System Performance

Storm-damage research has shown that sprayed polyurethane foam (SPF) and liquid-applied roof systems are very reliable high-wind performers. If the substrate to which the SPF or liquid-applied membrane is applied does not lift, it is highly unlikely that these systems will blow off. Both systems are also more resistant to leakage after missile impact damage than most other systems. Built-up roofs (BURs) and modified bitumen systems have also demonstrated good wind performance provided the edge flashing/coping does not fail (which happens frequently). The exception is aggregate surfacing, which is prone to blow-off (see Figures 4-10 and 4-81). Modified bitumen applied to a concrete deck has demonstrated excellent resistance to progressive peeling after blow-off of the metal edge flashing. Metal panel performance is highly variable. Some systems are very wind-resistant, while others are quite vulnerable.

Of the single-ply attachment methods, the paver-ballasted and fully adhered methods are the least problematic. Systems with aggregate ballast are prone to blow-off, unless care is taken in specifying the size of aggregate and the parapet height (see Figures 4-5, 4-46, and 4-47). The performance of protected membrane roofs (PMRs) with a factory-applied cementitious coating over insulation boards is highly variable. When these boards are installed over a loose-laid membrane, it is critical that an air retarder be incorporated to prevent the membrane from ballooning and disengaging the boards. ANSI/SPRI RP-4 (which is referenced in the IBC) provides wind guidance for ballasted systems using aggregate, pavers, and cementitious-coated boards.

The National Research Council of Canada, Institute for Research in Construction's *Wind Design Guide for Mechanically Attached Flexible Membrane Roofs* (B1049, 2005) provides recommendations related to mechanically attached single-ply and modified bituminous systems. B1049 is a comprehensive wind design guide that includes discussion on air retarders. Air retarders can be effective in reducing membrane flutter, in addition to being beneficial for use in ballasted single-ply systems. When a mechanically attached system is specified, careful coordination with the structural engineer in selecting deck type and thickness is important.

If a steel deck is selected, it is critical to specify that the membrane fasteners be attached in rows perpendicular to the steel flanges to avoid overstressing the attachment of the deck to the deck support structure. At the building shown in Figure 4-63, the fastener rows of the mechanically attached single-ply membrane ran parallel to the top flange of the steel deck. The deck fasteners were overstressed and a portion of the deck blew off and the membrane progressively tore. At another building, shown in Figure 4-64, the membrane fastener rows also ran parallel to the top flange of the steel deck. When membrane fasteners run parallel to the flange, the flange with membrane fasteners essentially carries the entire uplift load because of the deck's inability to transfer any significant load to adjacent flanges. Hence, at the joists shown in Figure 4-64, the deck fasteners on either side of the flange with the membrane fasteners are the only connections to the joist that are carrying substantial uplift load.

Figure 4-63:

The orientation of the membrane fastener rows led to blow-off of the steel deck. Hurricane Marilyn (U.S. Virgin Islands, 1995)



Figure 4-64:

View of the underside of a steel deck showing the mechanically attached single-ply membrane fastener rows running parallel to, instead of across, the top flange of the deck.



For metal panel roof systems, the following are recommended:

- When clip or panel fasteners are attached to nailers, detail the connection of the nailer to the nailer support (including the detail of where nailers are spliced over a support).
- When clip or panel fasteners are loaded in withdrawal (tension), screws are recommended in lieu of nails.
- For concealed clips over a solid substrate, it is recommended that chalk lines be specified so that the clips are correctly spaced.

- When the basic wind speed is 110 mph or greater, it is recommended that two clips be used along the eaves, ridges, and hips.
- For copper panel roofs in areas with a basic wind speed greater than 90 mph, it is recommended that Type 316 stainless steel clips and stainless steel screws be used in lieu of copper clips.
- Close spacing of fasteners is recommended at hip and ridge flashings (e.g., spacing in the range of 3 to 6 inches on center, commensurate with the design wind loads.)

Edge Flashings and Copings

Roof membrane blow-off is almost always a result of lifting and peeling of the metal edge flashing or coping, which serves to clamp down the membrane at the roof edge. Therefore, it is important for the design professional to carefully consider the design of metal edge flashings, copings, and the nailers to which they are attached. The metal edge flashing on the modified bitumen membrane roof shown in Figure 4-65 was installed underneath the membrane, rather than on top of it, and then stripped in. In this location, the edge flashing was unable to clamp the membrane down. At one area, the membrane was not sealed to the flashing. An ink pen was inserted into the opening prior to photographing to demonstrate how wind could catch the opening and lift and peel the membrane.



Figure 4-65:
The ink pen shows an opening that the wind can catch, and cause lifting and peeling of the membrane.

ANSI/SPRI ES-1, *Wind Design Standard for Edge Systems Used in Low Slope Roofing Systems* (2003) provides general design guidance including a methodology for determining the outward-acting load on the vertical flange of the flashing/coping (ASCE 7 does not provide this guidance).

ANSI/SPRI ES-1 is referenced in the IBC. ANSI/SPRI ES-1 also includes test methods for assessing flashing/coping resistance. This manual recommends a minimum safety factor of 3 for edge flashings, copings, and nailers for hospitals. For FMG-insured facilities, FMR-approved flashing should be used and FM Data Sheet 1-49 should also be consulted.

The traditional edge flashing/coping attachment method relies on concealed cleats that can deform under wind load and lead to disengagement of the flashing/coping (see Figure 4-66) and subsequent lifting and peeling of the roof membrane. When a vertical flange disengages and lifts up, the edge flashing and membrane are very susceptible to failure. Normally, when a flange lifts the failure continues to propagate and the metal edge flashing and roof membrane blows off.

Storm-damage research has revealed that, in lieu of cleat attachment, the use of exposed fasteners to attach the vertical flanges of copings and edge flashings has been found to be a very effective and reliable attachment method. The coping shown in Figure 4-67 was attached with 1/4-inch diameter stainless steel concrete spikes at 12 inches on center. When the fastener is placed in wood, #12 stainless steel screws with stainless steel washers are recommended. The fasteners should be more closely spaced in the corner areas (the spacing will depend upon the design wind loads). ANSI/SPRI ES-1 provides guidance on fastener spacing and thickness of the coping and edge flashing.

Figure 4-66:
The metal edge flashing on this hospital disengaged from the continuous cleat and the vertical flange lifted. Hurricane Hugo (South Carolina, 1989)



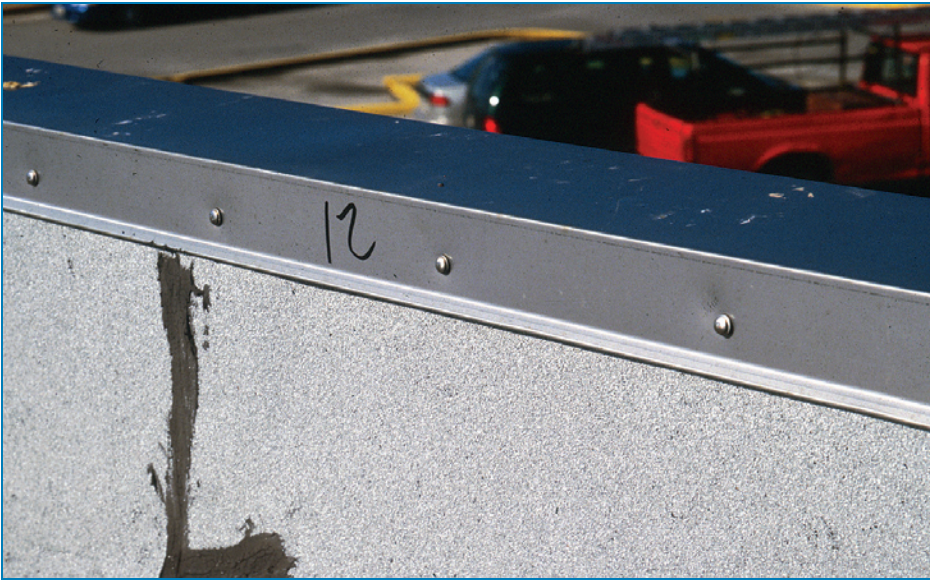

Figure 4-67:
Both vertical faces of the coping were attached with exposed fasteners instead of concealed cleats. Typhoon Paka (Guam, 1997)

Gutters

Storm-damage research has shown that gutters are seldom constructed to resist wind loads (see Figure 4-68). When a gutter lifts, it typically causes the edge flashing that laps into the gutter to lift as well. Frequently, this results in a progressive lifting and peeling of the roof membrane. The membrane blow-off shown in Figure 4-69 was initiated by gutter uplift. The gutter was similar to that shown in Figure 4-68. The membrane blow-off caused significant interior water damage.



Figure 4-68:
This gutter, supported by a type of bracket that provides no significant uplift resistance, failed when wind lifted it, together with the metal edge flashing that lapped into the gutter. Hurricane Francis (Florida, 2004)

Figure 4-69:
The original modified bitumen membrane was blown away after the gutter lifted in the area shown by the red arrow (the black membrane is a temporary roof). Hurricane Francis (Florida, 2004)



Special design attention needs to be given to attaching gutters to prevent uplift, particularly for those in excess of 6 inches in width. Currently, there are no standards pertaining to gutter wind resistance. It is recommended that the designer calculate the uplift load on gutters using the overhang coefficient from ASCE 7. There are two approaches to resist gutter uplift.

- Gravity-support brackets can be designed to resist uplift loads. In these cases, in addition to being attached at its top, the bracket should also be attached at its low end to the wall. The gutter also needs to be designed so it is attached securely to the bracket in a way that will effectively transfer the gutter uplift load to the bracket. Bracket spacing will depend on the gravity and uplift load, the bracket's strength, and the strength of connections between the gutter/bracket and the bracket/wall. With this option, the bracket's top will typically be attached to a wood nailer, and that fastener will be designed to carry the gravity load. The bracket's lower connection will resist the rotational force induced by gutter uplift. Because brackets are usually spaced close together to carry the gravity load, developing adequate connection strength at the lower fastener is generally not difficult.
- The other option is to use gravity-support brackets only to resist gravity loads, and use separate sheet-metal straps at 45-degree angles to the wall to resist uplift loads. Strap spacing will depend on the gutter uplift load and strength of the connections between the gutter/strap and the strap/wall. Note that FMG Data Sheet 1-49 recommends placing straps 10 feet apart. However, at that spacing with wide gutters, fastener loads induced by uplift are quite high. When straps are spaced at 10 feet, it can be difficult to achieve sufficiently strong uplift connections.

When designing a bracket's lower connection to a wall or a strap's connection to a wall, designers should determine appropriate screw pull-out values. With this option, a minimum of two screws at each end of a strap is recommended. At a wall, screws should be placed side by side, rather than vertically aligned, so the strap load is carried equally by the two fasteners. When fasteners are vertically aligned, most of the load is carried by the top fastener.

Since the uplift load in the corners is much higher than the load between the corners, enhanced attachment is needed in corner areas regardless of the option chosen. ASCE 7 provides guidance about determining a corner area's length.

Parapet Base Flashings

Information on loads for parapet base flashings was first introduced in the 2002 edition of ASCE 7. The loads on base flashings are greater than the loads on the roof covering if the parapet's exterior side is air-permeable. When base flashing is fully adhered, it has sufficient wind resistance in most cases. However, when base flashing is mechanically fastened, typical fastening patterns may be inadequate, depending on design wind conditions (see Figure 4-70). Therefore, it is imperative that the base flashing loads be calculated, and attachments designed to accommodate these loads. It is also important for designers to specify the attachment spacing in parapet corner regions to differentiate them from the regions between corners.



Figure 4-70: If mechanically attached base flashings have an insufficient number of fasteners, the base flashing can be blown away. Hurricane Andrew (Florida, 1992)

When the roof membrane is specified to be adhered, it is recommended that fully adhered base flashings be specified in lieu of mechanically attached base flashings. Otherwise, if the base flashing is mechanically attached, ballooning of the base flashing during high winds can lead to lifting and progressive peeling of the roof membrane.

Steep-Slope Roof Coverings

For a discussion of wind performance of asphalt shingle and tile roof coverings, see FEMA 488 (2005), 489 (2005), and 549 (2006). For recommendations pertaining to asphalt shingles and tiles, see Fact Sheets 19, 20, and 21 in FEMA 499 (2005).

4.3.3.8 Roof Systems in Hurricane-Prone Regions

The following types of roof systems are recommended for hospitals in hurricane-prone regions, because they are more likely to avoid water infiltration if the roof is hit by wind-borne debris, and also because these systems are less likely to become sources of wind-borne debris:

- In tropical climates where insulation is not needed above the roof deck, specify either liquid-applied membrane over cast-in-place concrete deck, or modified bitumen membrane torched directly to primed cast-in-place concrete deck.
- Install a secondary membrane over a concrete deck (if another type of deck is specified, a cover board may be needed over the deck). Seal the secondary membrane at perimeters and penetrations. Specify rigid insulation over the secondary membrane. Where the basic wind speed is up to 110 mph, a minimum 2-inch thick layer of insulation is recommended. Where the speed is between 110 and 130 mph, a total minimum thickness of 3 inches is recommended (installed in two layers). Where the speed is greater than 130 mph, a total minimum thickness of 4 inches is recommended (installed in two layers). A layer of $\frac{5}{8}$ -inch thick glass mat gypsum roof board is recommended over the insulation, followed by a modified bitumen membrane. A modified bitumen membrane is recommended for the primary membrane because of its somewhat enhanced resistance to puncture by small missiles compared with other types of roof membranes.
- When fully adhering boards to concrete decks, it is recommended that a planar flatness of a maximum of $\frac{1}{4}$ -inch variation over a 10 foot length (when measured by a straightedge) be specified. Prior to installation of the roof insulation, it is recommended that the planar flatness be checked with a straightedge. If the deck is outside of the

¼-inch variation, it is recommended that the high spots be ground or the low spots be suitably filled.

- The purpose of the insulation and gypsum roof board is to absorb missile energy. If the primary membrane is punctured or blown off during a storm, the secondary membrane should provide watertight protection unless the roof is hit with missiles of very high momentum that penetrate the insulation and secondary membrane. Figure 4-72 illustrates the merit of specifying a secondary membrane. The copper roof blew off the hospital's intensive care unit (ICU). Patients and staff were frightened by the loud noise generated by the metal panels as they banged around during the hurricane. Fortunately there was a very robust underlayment (a built-up membrane) that remained in place. Since only minor leakage occurred, the ICU continued to function.

When fully adhering insulation boards, it is recommended that the boards be no larger than 4 feet by 4 feet. It is also recommended that the board thickness not exceed 2 inches (1½ inches is preferable). Use of small thin boards makes it easier for the contractor to conform the boards to the substrate. At the hospital shown in Figure 4-71, 4 foot by 8 foot insulation boards were set in hot asphalt over a concrete deck. A few of the boards detached from the deck. The boards may have initiated the membrane blow off, or the membrane blow off may have been initiated by lifting and peeling of the metal edge flashing, in which case, loss of the insulation boards was a secondary failure.



Figure 4-71:
The blown off insulation (red arrow) may have initiated blow off of the roof membrane. Hurricane Ivan (Florida, 2004)

Figure 4-72:

The secondary membrane prevented leakage into the ICU after the copper roof blew off. Hurricane Andrew (Florida, 1992)



- For an SPF roof system over a concrete deck, where the basic wind speed is less than 130 mph, it is recommended that the foam be a minimum of 3 inches thick to avoid missile penetration through the entire layer of foam. Where the speed is greater than 130 mph, a 4-inch minimum thickness is recommended. It is also recommended that the SPF be coated, rather than protected with an aggregate surfacing.
- For a PMR, it is recommended that pavers weighing a minimum of 22 psf be specified. In addition, base flashings should be protected with metal (such as shown in Figure 4-79) to provide debris protection. Parapets with a 3-foot minimum height (or higher if so indicated by ANSI/SPRI RP-4, 2002) are recommended at roof edges. This manual recommends that PMRs not be used for hospitals in hurricane-prone regions where the basic wind speed exceeds 130 mph.
- For structural metal roofs, it is recommended that a roof deck be specified, rather than attaching the panels directly to purlins as is commonly done with pre-engineered metal buildings. If panels blow off buildings without roof decking, wind-borne debris and rain are free to enter the building.

Structural standing seam metal roof panels with concealed clips and mechanically seamed ribs spaced at 12 inches on center are recommended. If the panels are installed over a concrete deck, a modified bitumen secondary membrane is recommended if the deck has a slope less than $\frac{1}{2}:12$. If the panels are installed over a steel

deck or wood sheathing, a modified bitumen secondary membrane (over a suitable cover board when over steel decking) is recommended, followed by rigid insulation and metal panels. Where the basic wind speed is up to 110 mph, a minimum 2-inch-thick layer of insulation is recommended. Where the speed is between 110 and 130 mph, a total minimum thickness of 3 inches is recommended. Where the speed is greater than 130 mph, a total minimum thickness of 4 inches is recommended. Although some clips are designed to bear on insulation, it is recommended that the panels be attached to wood nailers attached to the deck, because nailers provide a more stable foundation for the clips.

If the metal panels are blown off or punctured during a hurricane, the secondary membrane should provide watertight protection unless the roof is hit with missiles of very high momentum. At the roof shown in Figure 4-73, the structural standing seam panel clips bore on rigid insulation over a steel deck. Had a secondary membrane been installed over the steel deck, the membrane would have likely prevented significant interior water damage and facility disruption.

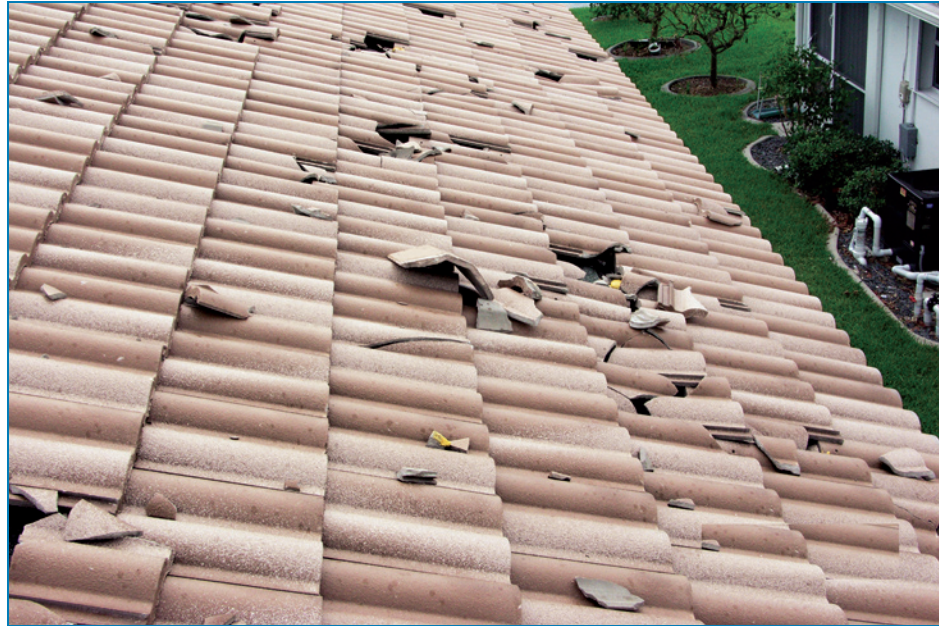

Figure 4-73: Significant interior water damage and facility interruption occurred after the standing seam roof blew off. Hurricane Marilyn (U.S. Virgin Islands, 1995)

- Based on field performance of architectural metal panels in hurricane-prone regions, exposed fastener panels are recommended in lieu of architectural panels with concealed clips. For panel fasteners, stainless steel screws are recommended. A secondary membrane protected with insulation is recommended, as discussed above for structural standing seam systems.

In order to avoid the possibility of roofing components blowing off and striking people arriving at a hospital during a storm, the following roof systems are not recommended: aggregate surfacings, either on BUR, single-ply or SPF; lightweight concrete pavers; cementitious-coated insulation boards; slate; and tile (see Figure 4-74). Even when slates and tiles are properly attached to resist wind loads, their brittleness makes them vulnerable to breakage as a result of wind-borne debris impact. The tile and slate fragments can be blown off the roof, and fragments can damage other parts of the roof, causing a cascading failure.

Figure 4-74:
Brittle roof coverings, like slate and tile, can be broken by missiles, and tile debris can break other tiles. Hurricane Charley (Florida, 2004)



Mechanically attached and air-pressure equalized single-ply membrane systems are susceptible to massive progressive failure after missile impact, and are therefore not recommended for hospitals in hurricane-prone regions. At the building shown in Figure 4-75, a missile struck the fully adhered low-sloped roof and slid into the steep-sloped reinforced mechanically attached single-ply membrane in the vicinity of the red arrow. A large area of the mechanically attached membrane was blown away as a result of progressive membrane tearing. Fully adhered single-ply membranes are very vulnerable to missile puncture and are not recommended unless they are ballasted with pavers. At the hospital shown in Figure 4-76, several missiles, including exhaust fans and copings struck the roof.



Figure 4-75:
Mechanically attached single-ply membrane progressively tore after being cut by wind-borne debris. Hurricane Andrew (Florida, 1992)



Figure 4-76:
This fully adhered single-ply roof membrane was struck by a variety of missiles. Hurricane Marilyn (U.S. Virgin Islands, 1995)

Edge flashings and copings: If cleats are used for attachment, it is recommended that a “peel-stop” bar be placed over the roof membrane near the edge flashing/coping, as illustrated in Figure 4-77. The purpose of the bar is to provide secondary protection against membrane lifting and peeling in the event that edge flashing/coping fails. A robust bar specifically made for bar-over mechanically attached single-ply systems is recommended. The bar needs to be very well anchored to the parapet or the deck. Depending on design wind loads, spacing between 4 and 12 inches on center is recommended. A gap of a few inches should be left between each bar to allow for water flow across the membrane. After the bar is attached, it is stripped over with a stripping ply.

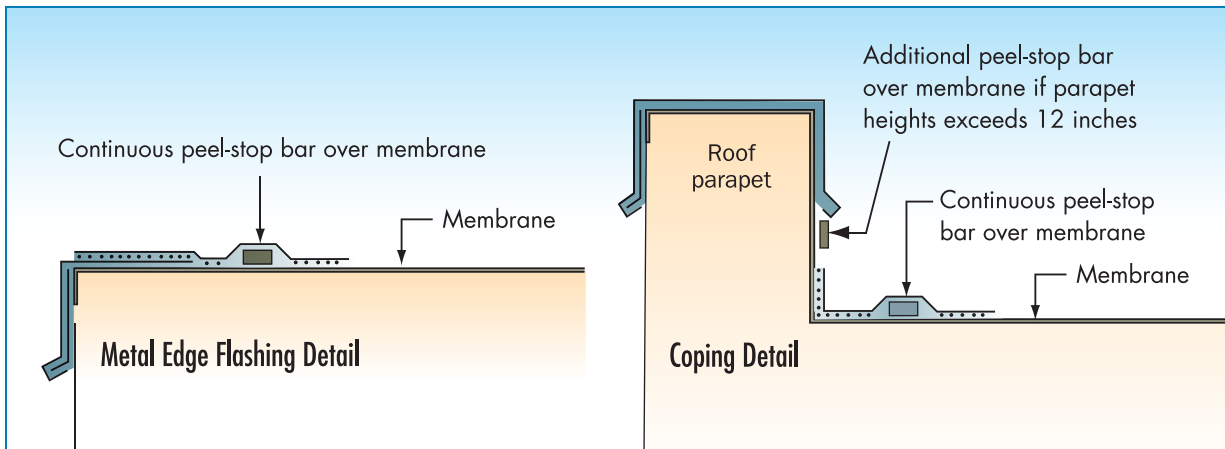

Figure 4-77:

A continuous peel-stop bar over the membrane may prevent a catastrophic progressive failure if the edge flashing or coping is blown off. (Modified from FEMA 55, 2000)

Walkway pads: Roof walkway pads are frequently blown off during hurricanes (Figures 4-78 and 4-82). Pad blow-off does not usually damage the roof membrane. However, wind-borne pad debris can damage other building components and injure people. Currently there is no test standard to evaluate uplift resistance of walkway pads. Walkway pads are therefore not recommended in hurricane-prone regions.

Figure 4-78:

Several rubber walkway pads were blown off the single-ply membrane roof on this hospital. Hurricane Katrina (Mississippi, 2005)



Parapets: For low-sloped roofs, minimum 3-foot high parapets are recommended. With parapets of this height or greater, the uplift load in the corner region is substantially reduced (ASCE 7 permits treating the corner zone as a perimeter zone). Also, a high parapet (as shown in Figures 4-96) may intercept wind-borne debris and keep it from blowing off the roof and damaging other building components or injuring people. To protect base flashings from wind-borne debris damage and subsequent water leakage, it is recommended that metal panels on furring strips be installed over the base flashing (Figure 4-79). Exposed stainless steel screws are recommended for attaching the panels to the furring strips, because using exposed fasteners is more reliable than using concealed fasteners or clips (as were used for the failed panels shown in Figure 4-62).



Figure 4-79:
Base flashing
protected by metal
panels attached with
exposed screws.
Hurricane Katrina
(Mississippi, 2005)

4.3.3.9 The Case of DeSoto Memorial Hospital, Arcadia, Florida

The case of DeSoto Memorial Hospital illustrates damage caused by aggregate-surfaced roofs. The 82-bed hospital is located just off Florida Highway 17 in Arcadia, approximately 30 miles east of Florida's gulf coast. The hospital was constructed in 1964, though the current emergency room (ER), ICU, and third floor patient rooms were added in 1984. A separate pre-engineered storage building was constructed in 1979.

The facility was struck by Hurricane Charley in 2004, with an estimated peak gust wind speed between 125 to 140 mph.¹¹ Since the design wind speed in the 2005 edition of ASCE 7 for this location is 110 mph, the esti-

¹¹The 125 to 140 mph speeds were estimated for Exposure C.

mated speeds at this site were above current design conditions. Also, even with the 1.15 importance factor, the actual wind pressures were above the design pressures.

The hospital sustained damage to windows, rooftop equipment, and a freestanding storage building on the campus. Thirty-three windows were broken, including patient room windows and windows at three of the eight ICU rooms (Figures 4-80 and 4-81). Windows were also broken in many vehicles in the parking lot. The majority of the glass breakage was caused by aggregate blown from the hospital built-up roofs. Some of the glass breakage may have been due to blown-off gutters and walkway pads from the hospital's roof (Figure 4-82) or other missiles such as tree limbs; blown off gutters can be high-momentum missiles that can travel a substantial distance (see Figure 4-81).

As a result of the window breakage the entire ICU was evacuated during the hurricane and closed for about 2 weeks before repairs were completed and the unit reoccupied. Some patients were moved to lower floors; the elevator could not be used so the patients were either carried down or slid down the stairs on mattresses. Fortunately, no one was injured during the evacuation.

A portion of the roof covering was blown off and the satellite dish was nearly blown off too. The LPS was displaced in a few areas (see Figure 4-83). As a result of the damage to the roof covering and to rooftop equipment, water leaked into the building in several areas, which caused the closing of the operating room (OR), sterile processing, portions of the lab, and numerous offices. The OR was temporarily relocated to the Caesarian section (C-section) room. It was about a month before the OR was repaired and reoccupied.

The metal storage building that contained the hospital's supplies, maintenance shop, environmental services, and shipping and receiving collapsed, and its loss was significant for the hospital operations. Almost all of the tools and stock materials for repairs were lost (Figure 4-84). Tents were set up after the hurricane to provide storage. Because of subsequent storms in the next several weeks (including two hurricanes), the stored items had to be moved in and out of the tents on several occasions.

Municipal power and water were lost during the hurricane. The hospital ran on its generators for about 5 days before power was restored. Municipal water service was out for about 2 weeks, but fortunately the hospital had a secondary well for potable water, so water service was not interrupted.

Access to the hospital was not hampered by fallen trees or by flooding. However, some staff and emergency medical service (EMS) personnel were unable to get to the hospital quickly after the storm because of downed trees or floodwaters in their neighborhoods. Landline telephone service was not lost, but paging and cell phone services were. The homes of many staff members were no longer habitable after the storm, so tents were set up on the hospital campus to house staff and volunteers that came to provide assistance. This in turn required additional security services and shower and laundry facilities.

The hospital did not have a contingency plan to cope with the damages, and therefore, did not have pre-arranged contracts with contractors to perform inspections and emergency repairs. Fortunately, there were no problems finding contractors quickly after the storm, although the building materials needed for repairs were in short supply.



Figure 4-80:
The second floor beyond the canopy houses the ICU. Several windows along the two ICU walls that are visible were broken.

Figure 4-81:
A view of the ICU
from the third floor
roof. The gutters (red
arrow) are from the
back side of the third
floor roof.



Figure 4-82:
View of the back
side of the third
floor roof where the
gutter and an asphalt
plank walkway pad
were blown away.
The loose aggregate
surfacing was also
blown away.





Figure 4-83:
This satellite dish was held down only with CMU. Note the displaced LPS at the corner (circled).



Figure 4-84:
This pre-engineered storage building contained the hospital supplies and maintenance shop.

4.3.4 NONSTRUCTURAL SYSTEMS AND EQUIPMENT

Nonstructural systems and equipment include all components that are not part of the structural system or building envelope. Exterior-mounted mechanical equipment (e.g., exhaust fans, HVAC units, relief air hoods, rooftop ductwork, and boiler stacks), electrical equipment (e.g., light fixtures and lightning protection systems), and communications equipment (e.g., antennae and satellite dishes) are often damaged during high winds. Damaged equipment can impair the operation of the facility, the equipment can detach and become wind-borne missiles, and water can

enter the facility where equipment was displaced (see Figure 4-85). The most common problems typically relate to inadequate equipment anchorage, inadequate strength of the equipment itself, and corrosion.

Exterior-mounted equipment is especially vulnerable to hurricane-induced damage, and special attention should be paid to positioning and mounting of these components in hurricane-prone regions. Specific information pertaining to hospitals located in hurricane-prone regions is presented for each of the nonstructural component sections below.

Figure 4-85:
This gooseneck was attached with only two small screws. A substantial amount of water was able to enter the building during Hurricane Francis. (Florida, 2004)



4.3.4.1 Exterior-Mounted Mechanical Equipment

This section discusses loads and attachment methods, as well as the problems of corrosion and water infiltration.

Loads and Attachment Methods¹²

Information on loads on rooftop equipment was first introduced in the 2002 edition of ASCE 7. For guidance on load calculations, see “*Calculating Wind Loads and Anchorage Requirements for Rooftop Equipment*” (ASHRAE, 2006). A minimum safety factor of 3 is recommended for hospitals. Loads and resistance should also be calculated for heavy pieces of equipment since the dead load of the equipment is often inadequate

¹² Discussion is based on: *Attachment of Rooftop Equipment in High-Wind Regions - Hurricane Katrina Recovery Advisory* (May 2006, revised July 2006)

to resist the design wind load. The 30' x 10' x 8' 18,000-pound HVAC unit shown in Figure 4-86 was attached to its curb with 16 straps (one screw per strap). Although the wind speeds were estimated to be only 85 to 95 miles per hour (peak gust), the HVAC unit blew off the medical office building. The inset at Figure 4-86 shows the curb upon which the unit was attached. A substantial amount of water entered the building at the curb openings before the temporary tarp was placed.

Mechanical penetrations through the elevator penthouse roof and walls must possess adequate wind and water resistance to ensure continuity of elevator service (see Section 4.3.3.5). In addition to paying special attention to equipment attachment, air intakes and exhausts should be designed and constructed to prevent wind-driven water from entering the penthouse.



Figure 4-86: Although this 18,000-pound HVAC unit was attached to its curb with 16 straps, it blew off during Hurricane Ivan. (Florida, 2004)



To anchor fans, small HVAC units, and relief air hoods, the minimum attachment schedule provided in Table 4-1 is recommended. The attachment of the curb to the roof deck also needs to be designed and constructed to resist the design loads. The cast-in-place concrete curb shown in Figure 4-87 was cold-cast over a concrete roof deck. Dowels were not installed between the deck and the curb, hence a weak connection occurred.

Figure 4-87:

The gooseneck on this hospital remained attached to the curb, but the curb detached from the deck. Typhoon Paka (Guam, 1997)



Fan cowling attachment: Fans are frequently blown off their curbs because they are poorly attached. When fans are well attached, the cowlings frequently blow off (see Figure 4-88). Blown off cowlings can tear roof membranes and break glazing. Unless the fan manufacturer specifically engineered the cowling attachment to resist the design wind load, cable tie-downs (see Figure 4-89) are recommended to avoid cowling blow-off. For fan cowlings less than 4 feet in diameter, 1/2-inch diameter stainless steel cables are recommended. For larger cowlings, use 3/16-inch diameter cables. When the basic wind speed is 120 mph or less, specify two cables. Where the basic wind speed is greater than 120 mph, specify four cables. To minimize leakage potential at the anchor point, it is recommended that the cables be adequately anchored to the equipment curb (rather than anchored to the roof deck). The attachment of the curb itself also needs to be designed and specified.

To avoid corrosion-induced failure (Figure 4-21), it is recommended that exterior-mounted mechanical, electrical, and communications equipment be made of nonferrous metals, stainless steel, or steel with minimum G-90 hot-dip galvanized coating for the equipment body, stands, anchors, and fasteners. When equipment with enhanced corrosion protection is not available, the designer should advise the building owner that periodic equipment maintenance and inspection is particularly important to avoid advanced corrosion and subsequent equipment damage during a windstorm.

Table 4-1: Number of #12 Screws for Base Case Attachment of Rooftop Equipment

Case No	Curb Size and Equipment Type	Equipment Attachment	Fastener Factor for Each Side of Curb or Flange
1	12" x 12" Curb with Gooseneck Relief Air Hood	Hood Screwed to Curb	1.6
2	12" x 12" Gooseneck Relief Air Hood with Flange	Flange Screwed to 22 Gauge Steel Roof Deck	2.8
3	12" x 12" Gooseneck Relief Air Hood with Flange	Flange Screwed to 15/32" OSB Roof Deck	2.9
4	24" x 24" Curb with Gooseneck Relief Air Hood	Hood Screwed to Curb	4.6
5	24" x 24" Gooseneck Relief Air Hood with Flange	Flange Screwed to 22 Gauge Steel Roof Deck	8.1
6	24" x 24" Gooseneck Relief Air Hood with Flange	Flange Screwed to 15/32" OSB Roof Deck	8.2
7	24" x 24" Curb with Exhaust Fan	Fan Screwed to Curb	2.5
8	36" x 36" Curb with Exhaust Fan	Fan Screwed to Curb	3.3
9	5'-9" x 3'- 8" Curb with 2'- 8" high HVAC Unit	HVAC Unit Screwed to Curb	4.5*
10	5'-9" x 3'- 8" Curb with 2'- 8" high Relief Air Hood	Hood Screwed to Curb	35.6*

Notes to Table 4-1:

- The loads are based on ASCE 7-05. The resistance includes equipment weight.
- The Base Case for the tabulated numbers of #12 screws (or ¼ pan-head screws for flange-attachment) is a 90-mph basic wind speed, 1.15 importance factor, 30' building height, Exposure C, using a safety factor of 3.
- For other basic wind speeds, multiply the tabulated number of #12 screws by $\left(\frac{V_D^2}{90^2}\right)$ to determine the required number of #12 screws (or ¼ pan-head screws) required for the desired basic wind speed, V_D (mph).
- For other roof heights up to 200', multiply the tabulated number of #12 screws by $(1.00 + 0.003 [h - 30])$ to determine the required number of #12 screws or ¼ pan-head screws for buildings between 30' and 200'.

Example A: 24" x 24" exhaust fan screwed to curb (table row 7), Base Case conditions (see Note 1): 2.5 screws per side; therefore, round up and specify 3 screws per side.

Example B: 24" x 24" exhaust fan screwed to curb (table row 7), Base Case conditions, except 120 mph: $120^2 \times 1 \div 90^2 = 1.78 \times 2.5$ screws per side = 4.44 screws per side; therefore, round down and specify 4 screws per side.

Example C: 24" x 24" exhaust fan screwed to curb (table row 7), Base Case conditions, except 150' roof height: $1.00 + 0.003 (150' - 30') = 1.00 + 0.36 = 1.36 \times 2.5$ screws per side = 3.4 screws per side; therefore, round down and specify 3 screws per side.

* This factor only applies to the long sides. At the short sides, use the fastener spacing used at the long sides.

Figure 4-88:

Cowlings blew off two of the three fans. Note also the loose lightning protection system conductors and missing walkway pad (red arrow). Hurricane Charley (Florida, 2004)



Figure 4-89:

Cables were attached to prevent the cowling from blowing off. Typhoon Paka (Guam, 1997)



Ductwork: To avoid wind and wind-borne debris damage to rooftop ductwork, it is recommended that ductwork not be installed on the roof (see Figures 4-16, 4-60, and 4-124). If ductwork is installed on the roof, it is recommended that the ducts' gauge and the method of attachment be able to resist the design wind loads.

Condenser attachment: In lieu of placing rooftop-mounted condensers on wood sleepers resting on the roof (see Figure 4-90), it is recommended that condensers be anchored to equipment stands. The attachment of the stand to the roof deck also needs to be designed to resist the design loads. In addition to anchoring the base of the condenser to the stand, two

metal straps with two side-by-side #12 screws or bolts with proper end and edge distances at each strap end are recommended when the basic wind speed is greater than 90 mph (see Figure 4-91).



Figure 4-90:
Sleeper-mounted condensers displaced by high winds. Hurricane Katrina (Mississippi, 2005)

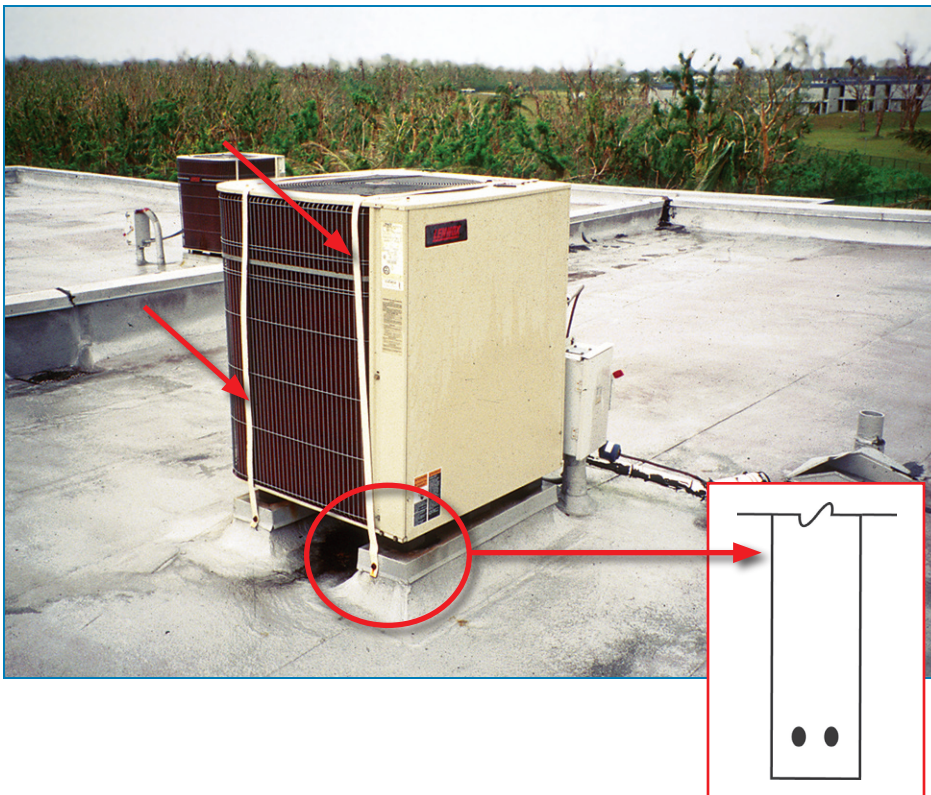

Figure 4-91:
This condenser had supplemental attachment straps (see red arrows). Typhoon Paka (Guam, 1997)

Three publications pertaining to seismic restraint of equipment provide general information on fasteners and edge distances:

- *Installing Seismic Restraints for Mechanical Equipment* (FEMA 412, 2002)
- *Installing Seismic Restraints for Electrical Equipment* (FEMA 413, 2004)
- *Installing Seismic Restraints for Duct and Pipe* (FEMA 414, 2004)

Vibration isolators: If vibration isolators are used to mount equipment, only those able to resist design uplift loads should be specified and installed, or an alternative means to accommodate uplift resistance should be provided (see Figure 4-92).

Figure 4-92: Failure of vibration isolators that provided lateral resistance but no uplift resistance caused equipment damage. A damaged vibration isolator is shown in the inset. Hurricane Katrina (Mississippi, 2005)

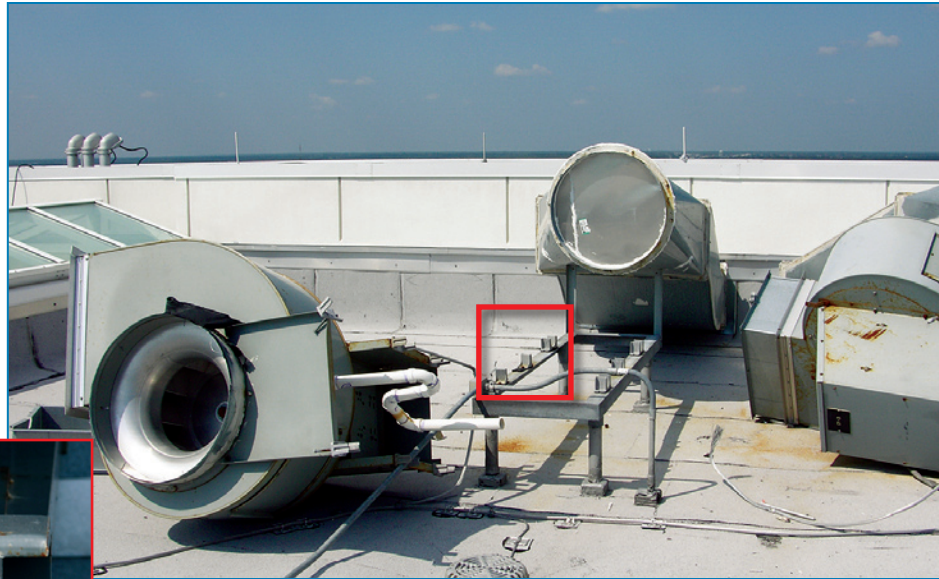

Boiler and exhaust stack attachment: To avoid wind damage to boiler and exhaust stacks, wind loads on stacks should be calculated and guy-wires should be designed and constructed to resist the loads. Topped stacks, as shown at the hospital in Figure 4-93, can allow water to enter the building at the stack penetration, damage the roof membrane, and become wind-borne debris. The designer should advise the building owner that guy-wires should be inspected annually to ensure they are taut.



Figure 4-93: Three of the five stacks that did not have guy-wires were blown down. Hurricane Marilyn (U.S. Virgin Islands, 1995)

Access panel attachment: Equipment access panels frequently blow off. To minimize this, job-site modifications, such as attaching hasps and locking devices like carabiners, are recommended. The modification details need to be customized. Detailed design may be needed after the equipment has been delivered to the job site. Modification details should be approved by the equipment manufacturer.

Equipment screens: Screens around rooftop equipment are frequently blown away (see Figure 4-94). Screens should be designed to resist the wind load derived from ASCE 7. Since the effect of screens on equipment wind loads is unknown, the equipment attachment behind the screens should be designed to resist the design load.



Figure 4-94: Equipment screen panels, such as these blown away at a hospital, can break glazing, puncture roof membranes, and cause injury. Hurricane Ivan (Florida, 2004)

Water Infiltration

During high winds, wind-driven rain can be driven through air intakes and exhausts unless special measures are taken. Louvers should be designed and constructed to prevent leakage between the louver and wall. The louver itself should be designed to avoid water being driven past the louver. However, it is difficult to prevent infiltration during very high winds. Designing sumps with drains that will intercept water driving past louvers or air intakes should be considered. ASHRAE 62.1 (2004) provides some information on rain and snow intrusion. The *Standard 62.1 User's Manual* provides additional information, including examples and illustrations of various designs.

4.3.4.2 Nonstructural Systems and Mechanical Equipment in Hurricane-Prone Regions

Elevators: Where interruption of elevator service would significantly disrupt facility operations, it is recommended that elevators be placed in separate locations within the building and be served by separate elevator penthouses. This is recommended, irrespective of the elevator penthouse enhancements recommended in Sections 4.3.3.5, 4.3.3.7, and 4.3.4.1, because of the greater likelihood that at least one of the elevators will remain operational and therefore allow the facility to function as intended, as discussed in Section 4.2.1.3.

Mechanical Penthouses: By placing equipment in mechanical penthouses rather than leaving them exposed on the roof, equipment can be shielded from high-wind loads and wind-borne debris. Although screens (such as shown in Figure 4-94) could be designed and constructed to protect equipment from horizontally-flying debris, they are not effective in protecting equipment from missiles that have an angular trajectory. It is therefore recommended that mechanical equipment be placed inside mechanical penthouses. The penthouse itself should be designed and constructed in accordance with the recommendations given in Sections 4.3.2.1, 4.3.3.6, and 4.3.3.8.

4.3.4.3 Exterior-Mounted Electrical and Communications Equipment

Damage to exterior-mounted electrical equipment is infrequent, mostly because of its small size (e.g., disconnect switches). Exceptions include communication towers, surveillance cameras, electrical service masts, satellite dishes, and lightning protection systems. The damage is typically caused by inadequate mounting as a result of failure to perform wind load calculations and anchorage design. Damage is also sometimes caused by corrosion (see Figure 4-21 and text box in Section 4.3.4.1 regarding corrosion).

Communication towers and poles: ANSI/C2 provides guidance for determining wind loads on power distribution and transmission poles and towers. AASHTO LTS-4M (amended by LTS-4-12 2001 and 2003, respectively) provides guidance for determining wind loads on light fixture poles (standards).

Both ASCE 7 and ANSI/TIA-222-G contain wind load provisions for communication towers (structures). The IBC allows the use of either approach. The ASCE wind load provisions are generally consistent with those contained in ANSI/TIA-222-G. ASCE 7, however, contains provisions for dynamically sensitive towers that are not present in the ANSI/TIA standard. ANSI/TIA classifies towers according to their use (Class I, Class II, and Class III). This manual recommends that towers (including antennae) that are mounted on, located near, or serve hospitals be designed as Class III structures.

Collapse of both large and small communication towers at hospitals is quite common during high-wind events (see Figures 4-15 and 4-95). These failures often result in complete loss of communication capabilities. In addition to the disruption of communications, collapsed towers can puncture roof membranes and allow water leakage into the hospital, unless the roof system incorporated a secondary membrane (as discussed in Section 4.3.3.8). At the tower shown in Figure 4-95, the anchor bolts were pulled out of the deck, which resulted in a progressive peeling of the fully adhered single-ply roof membrane. Tower collapse can also injure or kill people.



Figure 4-95: The collapse of the antenna tower caused progressive peeling of the roof membrane. Also note that the exhaust fan blew off the curb, but the high parapet kept it from blowing off the roof. Hurricane Andrew (Florida, 1992)

See Sections 4.3.1.1 and 4.3.1.5 regarding site considerations for light fixture poles, power poles, and electrical and communications towers.

Electrical service masts: Service mast failure is typically caused by collapse of overhead power lines, which can be avoided by using underground service. Where overhead service is provided, it is recommended that the service mast not penetrate the roof. Otherwise, a downed service line could pull on the mast and rupture the roof membrane.

Satellite dishes: For the satellite dish shown in Figure 4-96, the dish mast was anchored to a large metal pan that rested on the roof membrane. CMU was placed on the pan to provide overturning resistance. This anchorage method should only be used where calculations demonstrate that it provides sufficient resistance. In this case the wind approached the satellite dish in such a way that it experienced very little wind pressure. In hurricane-prone regions, use of this anchorage method is not recommended (see Figures 4-83 and 4-97).

Figure 4-96:
Common anchoring method for satellite dish. Hurricane Ivan (Florida, 2004)



Figure 4-97:
A satellite dish anchored similarly to that shown in Figure 4-96 was blown off this five-story building. Hurricane Charley (Florida, 2004)



Lightning protection systems: For attachment of building lightning protection systems higher than 100 feet above grade, and for buildings located where the basic wind speed is in excess of 90 mph, see the following section on attaching LPS in hurricane-prone regions.

4.3.4.4 Lightning Protection Systems (LPS) in Hurricane-Prone Regions

Lightning protection systems frequently become disconnected from rooftops during hurricanes. Displaced LPS components can puncture and tear roof coverings, thus allowing water to leak into buildings (see Figures 4-98 and 4-99). Prolonged and repeated slashing of the roof membrane by loose conductors (“cables”) and puncturing by air terminals (“lightning rods”) can result in lifting and peeling of the membrane. Also, when displaced, the LPS is no longer capable of providing lightning protection in the vicinity of the displaced conductors and air terminals.



Figure 4-98: An air terminal debonded from the hospital's roof. Displaced air terminals can puncture tough membranes, such as this modified bitumen membrane. Hurricane Ivan (Florida, 2004)



Figure 4-99: View of an end of a conductor at a hospital that became disconnected. Hurricane Katrina (Mississippi, 2005)

Lightning protection standards such as NFPA 780 and UL 96A provide inadequate guidance for attaching LPS to rooftops in hurricane-prone regions, as are those recommendations typically provided by LPS and roofing material manufacturers. LPS conductors are typically attached to the roof at 3-foot intervals. The conductors are flexible, and when they are exposed to high winds, the conductors exert dynamic loads on the conductor connectors (“clips”). Guidance for calculating the dynamic loads does not exist. LPS conductor connectors typically have prongs to anchor the conductor. When the connector is well-attached to the roof surface, during high winds the conductor frequently bends back the malleable connector prongs (see Figure 4-100). Conductor connectors have also debonded from roof surfaces during high winds. Based on observations after Hurricane Katrina and other hurricanes, it is apparent that pronged conductor connectors typically have not provided reliable attachment.

Figure 4-100:
The conductor deformed the prongs under wind pressure, and pulled away from the connector. Hurricane Katrina (Mississippi, 2005)



To enhance the wind performance of LPS, the following are recommended¹³:

Parapet attachment: When the parapet is 12-inches high or greater, it is recommended that the air terminal base plates and conductor connectors be mechanically attached with #12 screws that have minimum 1¼-inch embedment into the inside face of the parapet nailer and are properly sealed for watertight protection. Instead of conductor connectors that have prongs, it is recommended that mechanically attached looped connectors be installed (see Figure 4-101).

¹³Discussion is based on *Roof-top Attachment of Lightning Protection Systems in High-Wind Regions—Hurricane Katrina Recovery Advisory* (May 2006, Revised July 2006).



Figure 4-101:
This conductor was attached to the coping with a looped connector. Hurricane Katrina (Mississippi, 2005)

Attachment to built-up, modified bitumen, and single-ply membranes: For built-up and modified bitumen membranes, attach the air terminal base plates with asphalt roof cement. For single-ply membranes, attach the air terminal base plates with pourable sealer (of the type recommended by the membrane manufacturer).

In lieu of attaching conductors with conductor connectors, it is recommended that conductors be attached with strips of membrane installed by the roofing contractor. For built-up and modified bitumen membranes, use strips of modified bitumen cap sheet, approximately 9 inches wide at a minimum. If strips are torch-applied, avoid overheating the conductors. For single-ply membranes, use self-adhering flashing strips, approximately 9 inches wide at a minimum. Start the strips approximately 3 inches from either side of the air terminal base plates. Use strips that are approximately 3 feet long, separated by a gap of approximately 3 inches (see Figure 4-102).

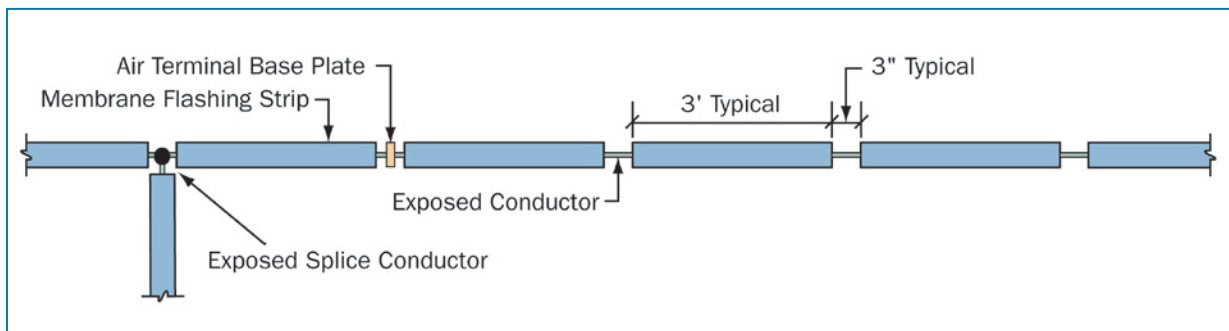

Figure 4-102: Plan showing conductor attachment

As an option to securing the conductors with stripping plies, conductor connectors that do not rely on prongs could be used (such as the one shown in Figure 4-103). However, the magnitude of the dynamic loads induced by the conductor is unknown, and there is a lack of data on the resistance provided by adhesively-attached connectors. For this reason, attachment with stripping plies is the preferred option, because the plies shield the conductor from the wind. If adhesive-applied conductor connectors are used, it is recommended that they be spaced more closely than the 3-foot spacing required by NFPA 780 and UL 96A. Depending on wind loads, a spacing of 6 to 12 inches on center may be needed in the corner regions of the roof, with a spacing of 12 to 18 inches on center at roof perimeters (see ASCE 7 for the size of corner regions).

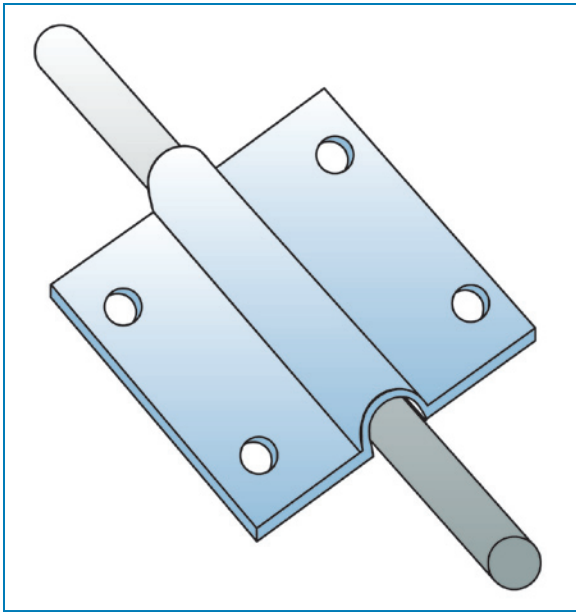

Figure 4-103:
Adhesively attached conductor connector that does not use prongs

induced by the conductor is unknown, and there is a lack of data on the resistance provided by adhesively-attached connectors. For this reason, attachment with stripping plies is the preferred option, because the plies shield the conductor from the wind. If adhesive-applied conductor connectors are used, it is recommended that they be spaced more closely than the 3-foot spacing required by NFPA 780 and UL 96A. Depending on wind loads, a spacing of 6 to 12 inches on center may be needed in the corner regions of the roof, with a spacing of 12 to 18 inches on center at roof perimeters (see ASCE 7 for the size of corner regions).

Mechanically attached single-ply membranes: It is recommended that conductors be placed parallel to, and within 8 inches of, membrane fastener rows. Where the conductor falls between or is perpendicular to membrane fastener rows, install an additional row of membrane fasteners where the conductor will be

located, and install a membrane cover-strip over the membrane fasteners. Place the conductor over the cover-strip and secure the conductor as recommended above.

By following the above recommendations, additional rows of membrane fasteners (beyond those needed to attach the membrane) may be needed to accommodate the layout of the conductors. The additional membrane fasteners and cover-strip should be coordinated with, and installed by, the roofing contractor.

Standing seam metal roofs: It is recommended that pre-manufactured, mechanically attached clips that are commonly used to attach various items to roof panels be used. After anchoring the clips to the panel ribs, the air terminal base plates and conductor connectors are anchored to the panel clips. In lieu of conductor connectors that have prongs, it is recommended that mechanically attached looped connectors be installed (see Figure 4-101).

It is recommended that the building designer advise the building owner to have the LPS inspected each spring, to verify that connectors are still attached to the roof surface, that they still engage the conductors, and that the splice connectors are still secure. Inspections are also recommended after high-wind events.

Conductor splice connectors: In lieu of pronged splice connectors (see Figure 4-104), bolted splice connectors are recommended because they provide a more reliable connection (see Figure 4-105). It is recommended that strips of flashing membrane (as recommended above) be placed approximately 3 inches from either side of the splice connector to minimize conductor movement and to avoid the possibility of the conductors becoming disconnected. To allow for observation during maintenance inspections, do not cover the connectors.



Figure 4-104: If conductors detach from the roof, they are likely to pull out from pronged splice connectors. Hurricane Charley (Florida, 2004)



Figure 4-105: Bolted splice connectors are recommended to prevent free ends of connectors from being whipped around by wind. Hurricane Katrina (Mississippi, 2005)

4.3.4.5 The Case of Martin Memorial Medical Center, Stuart, Florida

The case of Martin Memorial Hospital illustrates the importance of elevator penthouse envelopes. Martin Memorial Medical Center is a 244-bed facility located on the south bank of the St. Lucie River in Stuart, Florida. The original hospital building, opened in 1939, is still in use but not for patient care. Currently the main hospital building is the six-story North Tower constructed in the early 1970s. MOB's and a cancer treatment facility are also located on the hospital campus. In 2004 the facility was struck by Hurricane Frances, and about 3 weeks later by Hurricane Jeanne. The estimated peak gust wind speed at this site during Hurricane Frances was 100 mph.¹⁴ The design wind speed in the 2005 edition of ASCE 7 for this location is 140 mph.

The hospital sustained damage to the elevator penthouse, roof covering, and roof-mounted equipment. Many of the metal panels on the elevator penthouse of the North Tower that were blown off during Hurricane Frances (Figure 4-106) tore the roof membrane on the tower roof as well as on lower roofs. Mechanical equipment was damaged on the tower roof (Figure 4-107) and on lower roofs. The LPS was displaced on the tower roof (Figure 4-108) and on lower roofs. Unlike the windows on the first floor that were protected with shutters, the upper-level windows were not protected. However, none of them were broken, although a significant amount of water leaked through many of these windows. The second hurricane (Jeanne) caused additional water infiltration and interrupted reconstruction work.

Figure 4-106:
View of the reconstruction of the damaged walls at the elevator penthouse



¹⁴ The 100 mph speed was estimated for exposure C.

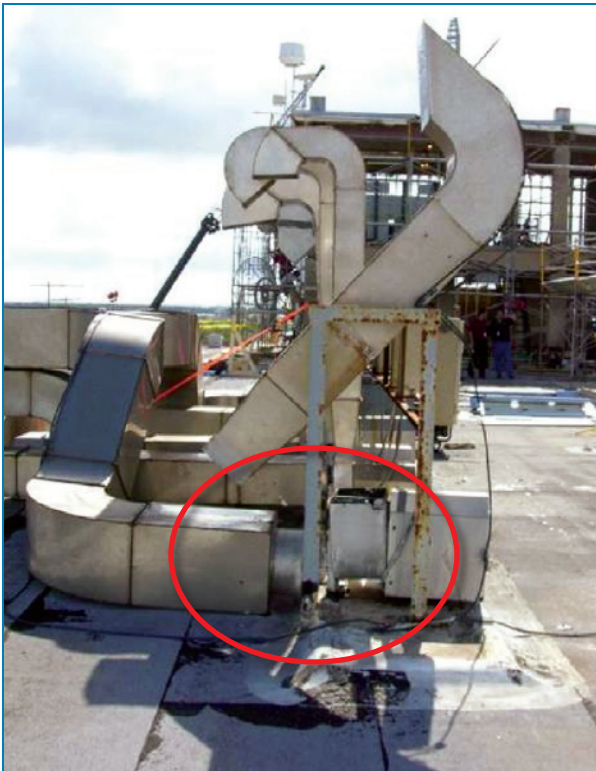

Figure 4-107:
Damaged HVAC equipment. Work is underway on the elevator penthouse beyond.



Figure 4-108:
Displaced LPS

Loss of the elevator penthouse panels allowed water infiltration into the elevator equipment room, which destroyed the control equipment. Water also leaked into the nursing floors, which made it necessary to evacuate the patients. Because of significant interior water damage and lack of vertical transportation, many patients had to be evacuated by helicopter.

As dramatically illustrated at this hospital, water infiltration and the lack of elevator service can take portions of the hospital offline for several weeks. Rather than simply replace the elevator penthouse walls, an engineer was retained to design a more wind-resistant wall covering system. The new design for the elevator penthouse wall system was developed and new elevator control equipment was installed, bringing the 5th floor back online about 4 weeks after the first hurricane struck. The remaining floors (2, 3, 4, and 6) were brought back online at a rate of about one floor every 2 weeks after the 5th floor was reopened. It cost \$3,733,233 to repair the North Tower. In addition to this expenditure, the hospital lost a significant amount of patient revenue.

Electrical service was interrupted for 36 hours (generators were used during that time), though there was no disruption of site access or water,

sewer, and communications services. The hospital had an existing contingency plan, which was helpful during the response to these hurricanes. For instance, the hospital had contractors on site the day after the hurricane struck to perform emergency repairs; some of these contractors were under a pre-arranged contract with the hospital. The contingency plan was updated and modified based on experiences with these two hurricanes.

4.3.5 MUNICIPAL UTILITIES IN HURRICANE-PRONE REGIONS

Hurricanes typically disrupt municipal electrical service, and often they disrupt telephone (both cellular and landline), water, and sewer services. These disruptions may last from several days to several weeks. Electrical power disruptions can be caused by damage to power generation stations and by damaged lines, such as major transmission lines and secondary feeders. Water disruptions can be caused by damage to water treatment or well facilities, lack of power for pumps or treatment facilities, or by broken water lines caused by uprooted trees. Sewer disruptions can be caused by damage to treatment facilities, lack of power for treatment facilities or lift stations, or broken sewer lines. Phone disruptions can be caused by damage at switching facilities and collapse of towers. Hospitals should be designed to prevent the disruption of services arising from prolonged loss of municipal services.

4.3.5.1 Electrical Power

It is recommended that buildings on hospital campuses that will be occupied during a hurricane, or will be needed within the first few weeks afterwards, be equipped with one or more emergency generators. In addition to providing emergency generators, it is recommended that one or more additional standby generators be considered, because continued availability of electrical power is vital. The purpose of providing the standby generators is to power those circuits that are not powered by the emergency generators. With both emergency and standby generators, the entire facility will be completely backed up. It is recommended that the emergency generator and standby generator systems be electrically connected via manual transfer switches to allow for interconnectivity in the event of emergency generator failure. The standby circuits can be disconnected from the standby generators, and the emergency circuits can be manually added. The emergency generators should be rated for prime power (continuous operation).

Running generators for extended time periods frequently results in equipment failure. Thus, provisions for back-up generation capacity are important, because the municipal power system may be out of service for

many days or even weeks. Therefore, it is recommended that an exterior box for single pole cable cam locking connectors be provided, so that a portable generator can be connected to the facility. With a cam locking box, if one or more of the emergency or standby generators malfunction, a portable generator can be brought to the facility and quickly connected. Back-up portable generators should be viewed as a third source of power (i.e., they should not replace standby generators), because it may take several days to get a back-up portable generator to the site.

Generators should be placed inside wind-borne debris resistant buildings (see recommendations in Sections 4.3.2.1, 4.3.3.2, 4.3.3.6 and 4.3.3.8) so that they are not susceptible to damage from debris or tree fall. Locating generators outdoors or inside weak enclosures (see Figure 4-138) is not recommended.

It is recommended that wall louvers for generators be capable of resisting the test Missile E load specified in ASTM E 1996. Alternatively, wall louvers can be protected with a debris-resistant screen wall so that wind-borne debris is unable to penetrate the louvers and damage the generators. If a screen wall is used, it should be designed to allow adequate air flow to the generator in order to avoid overheating the generator.

It is recommended that sufficient onsite fuel storage be provided to allow all of the facility's emergency and standby generators to operate at full capacity for a minimum of 96 hours (4 days).¹⁵ If at any time it appears that refueling won't occur within 96 hours, provision should be made to shut off part or all the standby circuits in order to provide longer operation of the emergency circuits. For remote facilities or situations where it is believed that refueling may not occur within 96 hours, the onsite fuel storage capacity should be increased as deemed appropriate. It is recommended that fuel storage tanks, piping, and pumps be placed inside wind-borne debris resistant buildings, or underground. If the site is susceptible to flooding, refer to Chapter 3 recommendations.

It is recommended that a minimum of 96 hours (4 days) of onsite fuel storage be provided for boilers. Storage tanks, piping, and pumps should be located within wind-borne debris resistant buildings or be placed underground (if site is susceptible to flooding, refer to Chapter 3).

4.3.5.2 Water Service

It is recommended that hospitals be provided with an independent water supply — a well or onsite water storage. If water is needed for cooling towers, the independent water supply should be sized to accommodate the system. It is recommended that the well or onsite storage be capable of providing an adequate water supply for fire sprinklers. Alternatively, it

¹⁵ The 96-hour fuel supply is based in part on the Department of Veterans Affairs criteria.

is recommended that the building designer should advise the building owner to implement a continual fire-watch and provide additional fire extinguishers until the municipal water service is restored. It is recommended that the well or onsite water storage be capable of providing a minimum of 100 gallons of potable water per day per patient bed for four days (the 100 gallons includes water for cooling towers).¹⁶

It is recommended that onsite storage of medical gases be sized to provide a minimum of 96 hours (4 days) of service.

It is recommended that pumps for wells or onsite storage be connected to an emergency power circuit, that a valve be provided on the municipal service line, and that onsite water treatment capability be provided where appropriate.

4.3.5.3 Sewer Service

It is recommended that hospitals be provided with an alternative means of waste disposal, such as a temporary storage tank that can be pumped out by a local contractor. It is also recommended that back-flow preventors be provided.

4.3.6 POST-DESIGN CONSIDERATIONS IN HURRICANE-PRONE REGIONS

In addition to adequate design, proper attention must be given to construction, post-occupancy inspections, and maintenance.

4.3.6.1 Construction Contract Administration

It is important for owners of hospitals in hurricane-prone regions to obtain the services of a professional contractor who will execute the work described in the contract documents in a diligent and technically proficient manner. The frequency of field observations and extent of special inspections and testing should be greater than those employed on hospitals that are not in hurricane-prone regions.

4.3.6.2 Periodic Inspections, Maintenance, and Repair

The recommendations given in Section 4.3.1.4 for post-occupancy and post-storm inspections, maintenance, and repair are crucial for hospitals in hurricane-prone regions. Failure of a building component that was not maintained properly, repaired, or replaced can present a considerable risk of injury or death to occupants, and the continued operation of the facility can be jeopardized.

¹⁶ This recommendation is based on the Department of Veterans Affairs criteria.

4.4 REMEDIAL WORK ON EXISTING FACILITIES

Many existing hospitals need to strengthen their structural or building envelope components. The reasons for this are the deterioration that has occurred over time, or inadequate facility strength to resist current design level winds. It is recommended that building owners have a vulnerability assessment performed by a qualified architectural and engineering team. A vulnerability assessment should be performed for all facilities older than 5 years. An assessment is recommended for all facilities located in areas where the basic wind speed is greater than 90 mph (even if the facility is younger than 5 years—see Figure 4-109). It is particularly important to perform vulnerability assessments on hospitals located in hurricane-prone and tornado-prone regions.

Components that typically make buildings constructed before the early 1990s vulnerable to high winds are weak non-load-bearing masonry walls, poorly connected precast concrete panels, long-span roof structures with limited uplift resistance, inadequately connected roof decks, weak glass curtain walls, building envelope, and exterior-mounted equipment. Although the technical solutions to these problems are not difficult, the cost of the remedial work is typically quite high. If funds are not available for strengthening or replacement, it is important to minimize the risk of injury and death by evacuating areas adjacent to weak non-load-bearing walls, weak glass curtain walls, and areas below long-span roof structures when winds above 60 mph are forecast.

As a result of building code changes and heightened awareness, some of the common building vulnerabilities have generally been eliminated for facilities constructed in the

Although it is unlikely, a hospital may occupy a building that was originally intended for another use. Buildings that were not designed for a critical occupancy were likely designed with a 1.0 rather than a 1.15 importance factor, and hence are not as wind-resistant as needed. It is particularly important to perform a vulnerability assessment if a hospital is located in a building not originally designed for a critical occupancy, especially if the hospital is located in a hurricane- or tornado-prone region.

mid-1990s or later. Components that typically remain vulnerable to high winds are the building envelope and exterior-mounted mechanical, electrical, and communications equipment. Many failures can be averted by identifying weaknesses and correcting them.

Figure 4-109:

The roof on this 5-year old hospital blew off. Water leaked into the patient floor below. The floor was taken out of service for more than a month. Hurricane Katrina (Mississippi, 2005)



By performing a vulnerability assessment, items that need to be strengthened or replaced can be identified and prioritized. A proactive approach in mitigating weaknesses can save significant sums of money and decrease disruption or total breakdown in hospital operations after a storm. For example, a vulnerability assessment on a hospital such as that shown in

Figure 4-110 may identify weakness of the roof membrane and/or rooftop equipment. Replacing weak components before a hurricane is much cheaper than replacing them and repairing consequential damages after a storm, and proactive work avoids the loss of use while repairs are made.

Before beginning remedial work, it is necessary to understand all significant aspects of the vulnerability of a hospital with respect to wind and wind-driven rain. If funds are not available to correct all identified deficiencies, the work should be systematically prioritized so that the items of greatest need are first corrected. Mitigation efforts can be very ineffective if they do not address all items that are likely to fail.



Figure 4-110:
The roof membrane and some of the rooftop equipment blew off. Although the deck was cast-in-place concrete, water leaked into the patient floor below. Hurricane Charley (Florida, 2004)

A comprehensive guide for remedial work on existing facilities is beyond the scope of this manual. However, the following are examples of mitigation measures that are often applicable.

4.4.1 STRUCTURAL SYSTEMS

As discussed in Section 4.1.4.1, roof decks on many facilities designed prior to the 1982 edition of the SBC and UBC and the 1987 edition of the NBC are very susceptible to failure. Poorly attached decks that are not upgraded are susceptible to blow-off, as shown in Figures 4-111 and 4-132. Decks constructed of cementitious wood-fiber, gypsum, and lightweight insulating concrete over form boards were commonly used on buildings built in the 1950s and 1960s. In that era, these types of decks, as well as precast concrete decks, typically had very limited uplift resistance due to weak connections to the support structure. Steel deck attachment is frequently not adequate because of an inadequate number of welds, or welds of poor quality. Older buildings with overhangs are particularly susceptible to blow-off, as shown in Figure 4-112, because older codes provided inadequate uplift criteria.

Figure 4-111:
The built-up roof blew off after one of the cementitious wood-fiber deck panels detached from the joists. Hurricane Katrina (Mississippi, 2005)

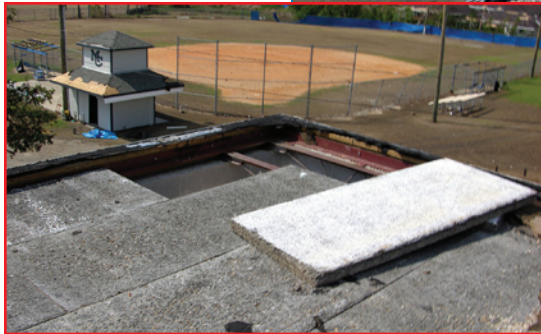

Figure 4-112:
The cementitious wood-fiber deck panels detached from the joists along the overhangs and caused the built-up membranes to lift and peel. Hurricane Katrina (Mississippi, 2005)



A vulnerability assessment of the roof deck should include evaluating the existing deck attachment, spot checking the structural integrity of the deck (including the underside, if possible), and evaluating the integrity of the beams/joists. If the deck attachment is significantly overstressed under current design wind conditions or the deck integrity is compromised, the deck should be replaced or strengthened as needed. The evaluation should be conducted by an investigator experienced with the type of deck used on the building.

If a low-slope roof is converted to a steep-slope roof, the new support structure should be engineered and constructed to resist the wind loads and avoid the kind of damage shown in Figure 4-113.



Figure 4-113:
The steel truss superstructure installed as part of a steep-slope conversion blew away because of inadequate attachment. Hurricane Marilyn (U.S. Virgin Islands, 1995)

4.4.2 BUILDING ENVELOPE

The following recommendations apply to building envelope components of existing hospitals.

4.4.2.1 Sectional and Rolling Doors

Sectional and rolling doors (e.g., at hospital loading docks and ambulance garages), installed in older buildings before attention was given to the wind resistance of these elements, are very susceptible to being blown away. Although weak doors can be retrofitted, it is difficult to ensure that the door, door tracks, and connections between the door and tracks are sufficient. It is therefore recommended that weak doors and tracks be replaced with new assemblies that have been tested to meet the factored design wind loads. As part of the replacement work, nailers between the tracks and building structure should either be replaced, or their attachment should be strengthened.

If a facility has more than one sectional or rolling door, all doors should be replaced, rather than just replacing one of the doors. The building shown in Figure 4-114 had six sectional doors. One door had been replaced before a hurricane. It performed very well, but three of the older doors were blown away and two of the older doors remained in place but had some wind damage.

Figure 4-114:

The new door in the center performed very well, but the older doors on either side of it were blown away. Hurricane Charley (Florida, 2004)

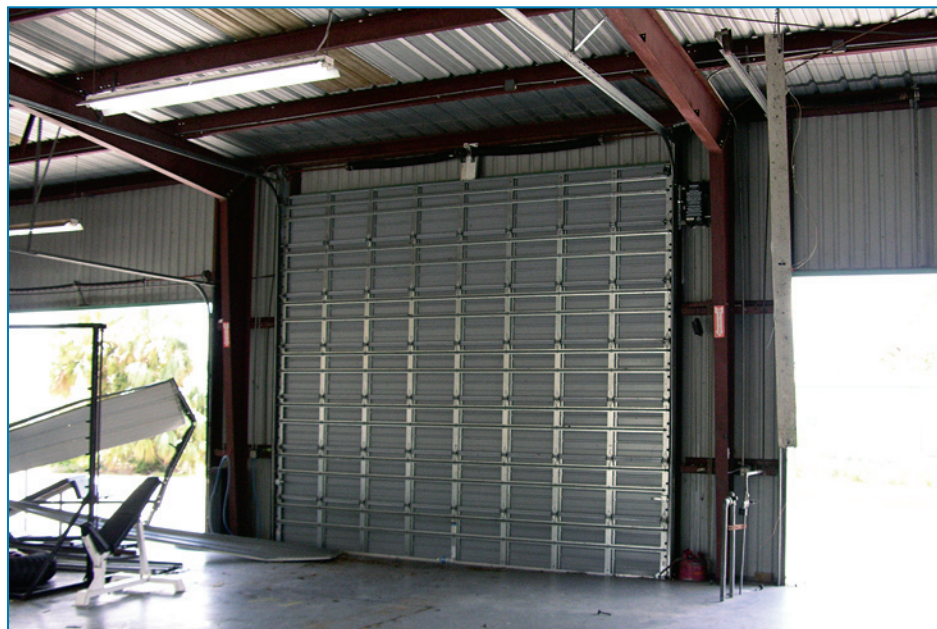

4.4.2.2 Windows and Skylights

Windows in older facilities may possess inadequate resistance to wind pressure. Window failures are typically caused by wind-borne debris, however, glazing or window frames may fail as a result of wind pressure (see Figure 4-115). Failure can be caused by inadequate resistance of the glazing, inadequate anchorage of the glazing to the frame, failure of the frame itself, or inadequate attachment of the frame to the wall. For older windows that are too weak to resist the current design pressures, window assembly replacement is recommended. Some older window assemblies have sufficient strength to resist the design pressure, but are inadequate to resist wind-driven rain. If the lack of water resistance is due to worn glazing gaskets or sealants, replacing the gaskets or sealant may be viable. In other situations, replacing the existing assemblies with new, higher-performance assemblies may be necessary.

It is recommended that all non-impact-resistant, exterior glazing located in hurricane-prone regions (with a basic wind speed of 100 mph or greater) be replaced with impact-resistant glazing or be protected with shutters, as discussed in Section 4.3.3.4. Shutters are typically a more economical approach for existing facilities. There are a variety of shutter types, all illustrated by Figures 4-116 to 4-118. Accordion shutters are permanently attached to the wall (Figure 4-116). When a hurricane is forecast, the shutters are pulled together and latched into place. Panel shutters (Figure 4-117) are made of metal or polycarbonate. When a hurricane is forecast, the shutters are taken from storage and inserted into metal tracks that are permanently mounted to the wall above and below

the window frame. The panels are locked into the frame with wing nuts or clips. Track designs that have permanently mounted studs for the nuts have been shown to be more reliable than track designs using studs that slide into the track. A disadvantage of panel shutters is the need for storage space. Roll-down shutters (Figure 4-118) can be motorized or pulled down manually. Figure 4-118 illustrates the benefits of shuttering. Two of the unprotected window units experienced glass breakage and the third window unit blew in.

Deploying accordion or panel shutters a few stories above grade is expensive. Although motorized shutters have greater initial cost, their operational cost should be lower. Other options for providing missile protection on upper levels include replacing the existing assemblies with laminated glass assemblies, or installing permanent impact resistant screens. Engineered films are also available for application to the interior of the glass. The film needs to be anchored to the frame, and the frame needs to be adequately anchored to the wall. The film degrades over time and requires replacement (approximately every decade). Use of laminated glass or shutters is recommended in lieu of engineered films.



Figure 4-115: Wind pressure caused the window frames on the upper floor to fail (red arrow). Hurricane Katrina (Mississippi, 2005)

Figure 4-116:
This building has
accordion shutters.
Hurricane Ivan
(Florida, 2004)



Figure 4-117:
A metal panel shutter.
Hurricane Georges
(Puerto Rico, 1998)





Figure 4-118:
The lower window assembly was protected with a motorized shutter. Hurricane Ivan (Florida, 2004)

4.4.2.3 Roof Coverings

For roofs with weak metal edge flashing or coping attachment, face-attachment of the edge flashing/coping (as shown in Figure 4-67) is a cost-effective approach to greatly improve the wind-resistance of the roof system.

The vulnerability assessment of roofs ballasted with aggregate, pavers, or cementitious-coated insulation boards, should determine whether the ballast complies with ASNI/SPRI RP-4. Corrective action is recommended for non-compliant roof coverings. It is recommended that roof coverings with aggregate surfacing, lightweight pavers, or cementitious-coated insulation boards on buildings located in hurricane-prone regions be replaced to avoid blow-off (Figures 4-5, 4-46, and 4-47).

When planning the replacement of a roof covering, it is recommended that all existing roof covering be removed down to the deck rather than simply re-covering the roof. Tearing off the covering provides an opportunity to evaluate the structural integrity of the deck and correct deck attachment and other problems. For example, if a roof deck was deteriorated due to roof leakage (see Figure 4-119), the deterioration would likely not be identified if the roof was simply re-covered. By tearing off

down to the deck, deteriorated decking like that shown in Figure 4-119 can be found and replaced. In addition, it is recommended that the attachment of the wood nailers at the top of parapets and roof edges be evaluated and strengthened where needed, to avoid blow-off and progressive lifting and peeling of the new roof membrane (see Figure 4-126).

Figure 4-119:

The built-up roof was blown off after a few of the rotted wood planks detached from the joists. Hurricane Katrina (Mississippi, 2005)



If the roof has a parapet, it is recommended that the inside of the parapet be properly prepared to receive the new base flashing. In many instances, it is prudent to re-skin the parapet with sheathing to provide a suitable substrate. Base flashing should not be applied directly to brick parapets because they have irregular surfaces that inhibit good bonding of the base flashing to the brick (see Figure 4-120). Also, if moisture drives into the wall from the exterior side of the parapet with base flashing attached directly to brick, the base flashing can inhibit drying of the wall. Therefore, rather than totally sealing the parapet with membrane base flashing, the upper portion of the brick can be protected by metal panels (as shown in Figure 4-79), which permit drying of the brick.

If the parapet is constructed of masonry, it is recommended that its wind resistance be evaluated and strengthened if found to be inadequate. The masonry parapet shown in Figure 4-139 fell onto the roof. Had it fallen in the other direction, it would have blocked the entry and would have had the potential to cause injury.



Figure 4-120:
Failed base flashing
adhered directly to
the brick parapet.
Hurricane Katrina
(Louisiana, 2005)

4.4.3 EXTERIOR-MOUNTED EQUIPMENT

Exterior-mounted equipment on existing hospitals should be carefully examined and evaluated.

4.4.3.1 Antenna (Communications Mast)

Antenna collapse is very common. Besides loss of communications, collapsed masts can puncture roof membranes or cause other building damage as shown in Figure 4-121. This case also demonstrates the benefits of a high parapet. Although the roof still experienced high winds that blew off this penthouse door, the parapet prevented the door from blowing off the roof (red arrow in Figure 4-121).

In hurricane-prone regions, it is recommended that antennae strength be evaluated as part of the vulnerability assessment. Chapter 15 of ANSI/TIA-222-G provides guidance on the structural evaluation of existing towers. Appendix J of that standard contains checklists for maintenance and condition assessments. Additional bracing, guy-wires, or tower strengthening or replacement may be needed.

Fastening rooftop equipment to curbs, as discussed in Section 4.3.4.1, is a cost-effective approach to minimize wind-induced problems.

Figure 4-121:
The antenna at this hospital collapsed and was whipped back and forth across the roof membrane. Hurricane Andrew (Florida, 1992)



4.4.3.2 Lightning Protection Systems

Adhesively attached conductor connectors and pronged splice connectors typically have not provided reliable attachment during hurricanes. To provide more reliable attachment for LPS located in hurricane-prone regions where the basic wind speed is 100 mph or greater, or on hospitals more than 100 feet above grade, it is recommended that attachment modifications based on the guidance given in Section 4.3.4.4 be used.

4.4.4 THE CASE OF BAPTIST HOSPITAL, PENSACOLA, FLORIDA

The case of Baptist Hospital illustrates the challenges faced by older facilities. Baptist Hospital is a 492-bed tertiary care hospital located in downtown Pensacola on West Moreno St. approximately 2 miles north of Pensacola Bay. This hospital campus, which dates back to the 1950s, includes the hospital itself, a psychiatric hospital, and MOBs.

This facility was also struck by Hurricane Ivan. The estimated wind speed and design wind speed at this hospital are the same as the case study presented in Section 4.2.1.3. Figure 4-122 shows the site plan and Figure 4-123 is a general view from the northwest (looking southeast).

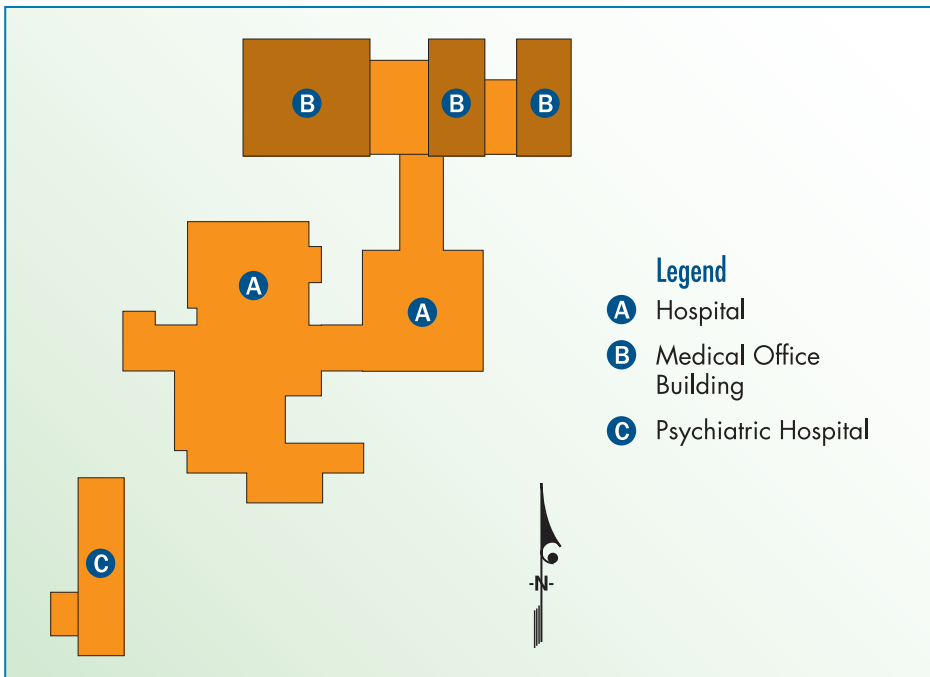

Figure 4-122:
Site plan



Figure 4-123:
General view

Damage

Water entered the hospital at damaged rooftop equipment (Figure 4-124), and at areas where the roof membrane blew off (Figures 4-125 and 4-126) and where it was punctured. The roof failure shown in Figure 4-126 was caused by an inadequately attached edge nailer anchored to the brick wall. Failure of the nailer caused a progressive lifting and peeling of the roof membrane. Gutters and downspouts were blown off and a few windows were broken. The elevator penthouse roof was damaged at the psychiatric hospital (Figure 4-127) and the MOBs (Figure 4-125).

Figure 4-124:

This hospital had a substantial amount of rooftop ductwork. Ductwork and fan units were damaged in several locations (see inset). Some of the windows in this area were also broken. Note the missing downspout (yellow arrow).

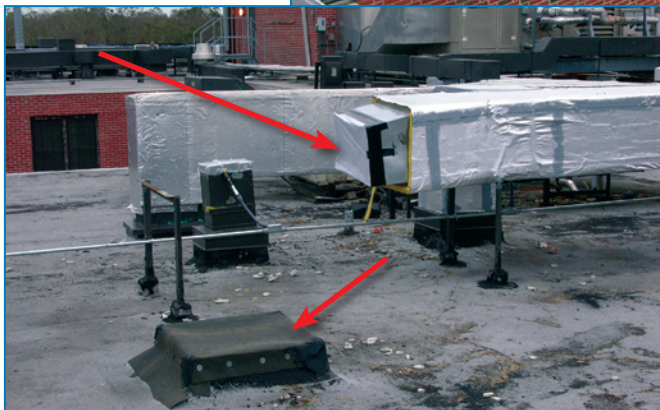

Figure 4-125:

The roof covering blew off – an emergency roof covering had been installed (yellow arrow). Note the damaged MOB penthouse beyond (red arrow).





Figure 4-126:
The roof covering blew off – an emergency roof covering had been installed (blue arrow). The failure was caused by the inadequately attached nailer (see inset). The leaning mast at the right is a ladder (yellow arrow), with an extension for communications and an anemometer for the nearby heliport.



Figure 4-127:
An emergency roof covering had been installed over the elevator penthouse at the psychiatric hospital.

4.5 BEST PRACTICES IN TORNADO-PRONE REGIONS

Strong and violent tornadoes may reach wind speeds substantially greater than those recorded in the strongest hurricanes. The wind pressures that these tornadoes can exert on a building are tremendous, and far exceed the minimum pressures derived from building codes.

Strong and violent tornadoes can generate very powerful missiles. Experience shows that large and heavy objects, including vehicles, can be hurled into buildings at high speeds. The missile sticking out of the roof in the foreground of Figure 4-128 is a double 2-inch by 6-inch wood member. The portion sticking out of the roof is 13 feet long. It penetrated a ballasted ethylene propylene diene monomer (EPDM) membrane, approximately 3 inches of polyisocyanurate roof insulation, and the steel roof deck. The missile lying on the roof just beyond is a 2-inch by 10-inch by 16-foot long wood member.

Figure 4-128:
A violent tornado showered the roof with missiles. (Oklahoma, 1999)



Besides the case studies presented in Sections 4.5.1 and 4.5.2, there is little documentation regarding tornado-induced damage to hospitals. Most of the damage reports on critical facilities pertain to schools because schools are the most prevalent type of critical facilities and, therefore, are more likely to be struck. A 1978 report prepared for the Veterans Administration¹⁷ identified four hospitals that were struck by tornadoes between 1973 and 1976. Table 4-2 (taken from that report) further illustrates the effects tornados can have on hospitals.

Table 4-2: Examples of Ramifications of Tornado Damage at Four Hospitals

Location and Building Characteristics	Tornado Characteristics	Damage	Ramifications of Damage
Mountain View, Missouri (St. Francis Hospital). One-story steel frame with non-load bearing masonry exterior walls.	The tornado crossed over one end of the hospital.	Metal roof decking was blown off, some windows were broken, and rooftop mechanical equipment was displaced.	Patients were moved to undamaged areas of the hospital.
Omaha, Nebraska (Bishop Bergen Mercy Hospital). Five-story reinforced concrete frame.	Maximum wind speed estimated at 200 mph. Proximity to hospital not documented.	Windows were broken, and rooftop mechanical equipment was damaged and displaced. Communications and electrical power were lost (emergency generators provided power).	A few minor cuts; "double walled corridors" provided protection for patients and staff. Some incoming emergency room patients (injured elsewhere in the city) were rerouted to other hospitals. Loss of communications hampered the rerouting.
Omaha, Nebraska (Bishop Bergen Mercy Hospital – Ambulatory Care Unit). One-story load bearing CMU walls with steel joists.	See above.	The building was a total loss due to wall and roof collapse.	Patients were evacuated to the first floor of the main hospital when the tornado watch was issued.
Corsicana, Texas (Navarro County Memorial Hospital). Five-story reinforced concrete frame with masonry non-load bearing walls in some areas and glass curtain walls.	The tornado was very weak.	Many windows were broken by aggregate from the hospital's built-up roofs. Intake duct work in the penthouse collapsed.	Two people in the parking lot received minor injuries from roof aggregate. Electrical power was lost for 2 hours (emergency generators provided power).
Monahans, Texas (Ward Memorial Hospital). One-story load bearing CMU walls with steel joists. Some areas had metal roof deck and others had gypsum deck.	The tornado passed directly over the hospital, with maximum wind speed estimated at 150 mph.	The roof structure was blown away on a portion of the building (the bond beam pulled away from the wall). Many windows were broken. Rooftop mechanical equipment was damaged.	

17 A Study of Building Damage Caused by Wind Forces, McDonald, J.R. and Lea, P.A, Institute for Disaster Research, Texas Tech University, 1978.

In this manual, the term “tornado-prone regions” refers to those areas of the United States where the number of recorded F3, F4, and F5 tornadoes per 3,700 square miles is 6 or greater per year (see Figure 4-129). However, an owner of a hospital may decide to use other frequency values (e.g., 1 or greater, 16 or greater, or greater than 25) in defining whether the hospital is in a tornado-prone area. In this manual, tornado shelters are recommended for all hospitals in tornado-prone regions.

Where the frequency value is 1 or greater, and the hospital does not have a tornado shelter, the best available refuge areas should be identified, as discussed at the end of this Section.

For hospitals located in tornado-prone regions (as defined in the text box), the following are recommended:

- Incorporate a shelter within the facility to provide occupant protection. For shelter design, FEMA 361 criteria are recommended.
- For interior non-load-bearing masonry walls, see the recommendations given in 4.3.3.5.
- Brick veneer, aggregate roof surfacing, roof pavers, slate, and tile cannot be effectively anchored to prevent them from becoming missiles if a strong or violent tornado passes near a building with these components. To reduce the potential number of missiles, and hence reduce the potential for building damage and injury to people, it is recommended that these materials not be specified for hospitals in tornado-prone regions.
- To minimize disruption from nearby weak tornadoes and from strong and violent tornados that are on the periphery of a hospital, the following are recommended:
 - 1) For the roof deck, exterior walls, and doors, follow the recommendations given in Sections 4.3.2.1, 4.3.3.2, and 4.3.3.6.
 - 2) For exterior glazing, specify laminated glass window assemblies that are designed to resist the test Missile E load specified in ASTM E 1996, and are tested in accordance with ASTM E 1886. Note that missile loads used for designing

It is recommended that hospitals have a National Oceanic and Atmospheric Administration (NOAA) weather radio, so that they will be aware of tornado watches and warnings. It is also recommended that hospitals have a plan to distribute notice of watches and warnings received via the radio to hospital staff.

tornado shelters significantly exceed the missile loads used for designing glazing protection in hurricane-prone regions. Missiles from a strong or violent tornado passing near the facility could penetrate the laminated glazing and result in injury or interior damage. Therefore, to increase occupant safety, even when laminated glass is specified, the facility should also incorporate a shelter as recommended above.

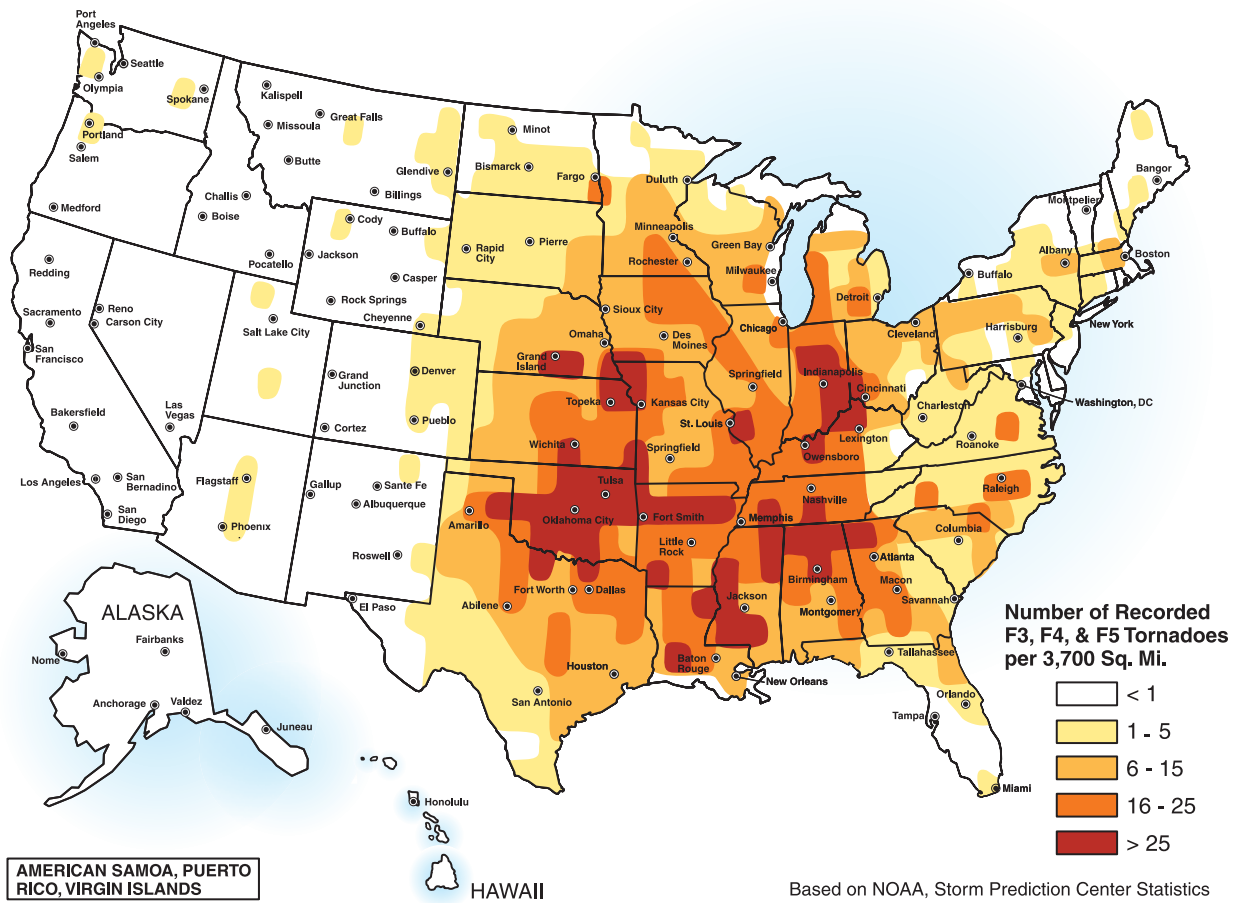

Figure 4-129: Frequency of recorded F3, F4, and F5 tornadoes (1950-1998)

Existing Hospitals without Tornado Shelters

Where the number of recorded F3, F4, and F5 tornadoes per 3,700 square miles is one or greater (see Figure 4-129), the best available refuge areas should be identified if the hospital does not have a tornado shelter. FEMA 431, *Tornado Protection, Selecting Refuge Areas in Buildings* provides useful information for building owners, architects, and engineers who perform evaluations of existing facilities.

To minimize casualties in hospitals, it is very important that the best available refuge areas be identified by a qualified architect or engineer.¹⁸ Once identified, those areas need to be clearly marked so that occupants can reach the refuge areas without delay. Building occupants should not wait for the arrival of a tornado to try to find the best available refuge area

¹⁸It should be understood that the occupants of a “best available refuge area” are still vulnerable to death and injury if the refuge area was not specifically designed as a tornado shelter.

in a particular facility; by that time, it will be too late. If refuge areas have not been identified beforehand, occupants will take cover wherever they can, frequently in very dangerous places. Corridors, as shown in Figure 4-142, sometimes provide protection, but they can also be death traps.

Retrofitting a shelter space inside an existing hospital can be very expensive. An economical alternative is an addition that can function as a shelter as well as serve another purpose. This approach works well for smaller facilities. For very large facilities, constructing two or more shelter additions should be considered in order to reduce the time it takes to reach the shelter (often there is ample warning time, but sometimes an approaching tornado is not noticed until a few minutes before it strikes). This is particularly important for hospitals because of the difficulty of accommodating patients with different medical needs.

4.5.1 THE CASE OF KIOWA COUNTY MEMORIAL HOSPITAL, GREENSBURG, KANSAS

The case of Kiowa County Memorial Hospital illustrates damage that is indicative of smaller, older facilities that are struck by strong tornadoes. The hospital is a 28-bed, one-story facility. The original hospital comprised three separate buildings (two of these are shown in Figure 4-131): a patient wing, a kitchen facility, and an equipment building, and was constructed in 1950. Additions were built in 1965 and 1982. A separate, ambulance garage was built prior to 1979, and a separate pre-engineered metal storage building was added in 2006. The original buildings had precast twin-tee roof structures and at the time of the storm, they had aggregate ballasted single-ply membrane roof systems. The additions all had different structural systems. The 1965 patient wing addition had a concrete topping slab over metal form deck over steel roof joists. The 1982 addition, which housed the emergency room, semi-intensive care, operating room, MRI, lab, medical records, and business offices, had a plywood roof deck over wood joists. The ambulance garage had a precast twin-tee roof structure.

Except for the storage building, the majority of the exterior walls were brick veneer over unreinforced CMU. A finished basement was built under portions of the 1965 and 1982 additions (the two basements were not interconnected).

Figure 4-130 shows the site plan.

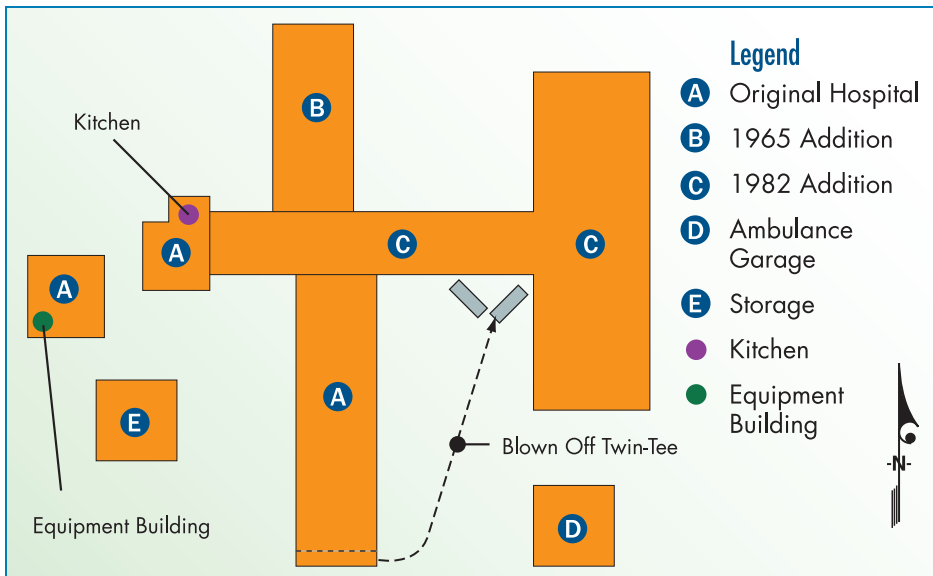

Figure 4-130:
Site Plan

The hospital was struck by a tornado in 2007. The National Weather Service rated a portion of the track as an EF5 (with an estimated peak gust speed in excess of 200 mph). At the hospital site, the damage was indicative of an EF3 (with a speed between 136 and 165 mph). The 2005 edition of ASCE 7 lists the design wind speed for this location as 90 mph. Therefore, the speeds at this site were well above current design conditions.



Figure 4-131:
The building housing the generator is shown by the yellow arrow. The kitchen facility is shown by the blue arrow. The red arrow shows the collapsed storage building.

Using the *Damage Indicators in the Enhanced Fujita Scale (EF-Scale)* for the main portion of the hospital, the *Degree of Damage (DOD)* indicated an expected wind speed during the tornado of 142 mph (with lower and upper bounds ranging from 119 to 163 mph). Failure analysis of the precast twin-tee that blew off the hospital indicated that a speed of approximately 147 mph was needed to blow off the tee, and a speed of approximately 193 mph was needed to toss it the 80 feet that it traveled.

The DOD at the pre-engineered storage building indicated an expected wind speed of 155 mph (with lower and upper bounds ranging from 132 to 178 mph).

Thus, the DOD of the hospital, the DOD of the storage building and the failure analysis of tee blow off indicate essentially the same estimated speed (142, 147, and 155 mph). The upper bound values of the DODs (163 and 178 mph) are lower than the 193 mph speed that was calculated to have tossed the tee. Based on the EF-Scale DODs, the 193 mph speed appears to be high.

One of the precast twin-tees from the original building blew off and flew approximately 80 feet (Figures 4-132 and 4-133). Where the tees rested on the bearing wall, steel bearing plates were embedded in the tee's beams, and bearing plates were embedded on top of the wall. At the wall in the foreground of Figure 4-132, the bearing plates had not been welded together. Hence, at that end of the tee, no uplift resistance was provided other than the tee's dead load. At the opposite bearing wall, the bearing plates were welded, but the bolts anchoring the plates to the wall failed in tension as the tee lifted. Both of the bearing plates had two small anchor bolts (about $\frac{3}{8}$ -inch diameter).

Figure 4-132:

View of the end of the patient wing where the twin-tee blew off. Note the missing window.





Figure 4-133:
The missing tee shown in Figure 4-132 landed about 80 feet away (red oval). The red arrows show tees that were blown from the ambulance garage. Note the missing wood roof structure on the 1982 addition (yellow arrow).

The hospital complex was struck with a very large number of missiles. Virtually all of the hospital's exterior glazing was broken. Figure 4-134 shows a damaged door at the kitchen facility. A piece of built-up roof (BUR) membrane struck the right door. Although the doors were out-swinging, the missile pushed the door inward. The lower right hinge was broken, and the right side of the door frame buckled and pulled from the rough opening. The laminated glass in the door was broken, but remained in place.



Figure 4-134:
The BUR missile (red arrow) struck the right door. Missiles also punctured the siding and wood sheathing (red oval).

Aggregate from the ballasted single-ply membrane roofs broke several windows (Figure 4-135), and pieces of the large aggregate (1½-inches in diameter, nominal) were found inside the building. Windows were also broken by 2x wood framing (Figure 4-136).



Figure 4-135:

All six panes of glass were broken. The craters shown in the right center pane and at the vehicle windshield were caused by the large aggregate blown from the ballasted single-ply membranes.



Figure 4-136:

A large missile (2x framing) penetrated this patient room. Note the debris on the bed in the inset (the arrow shows the same 2x missile).

Figure 4-137 illustrates an opening through the entire exterior wall.



Figure 4-137:

A missile impact created an opening in the brick veneer and unreinforced CMU.

The building shown in Figure 4-131 (yellow arrow) and in Figure 4-138 housed the emergency generator. The sectional door collapsed and allowed wind-borne debris to strike the generator. All window panes in the wall adjacent to the sectional door were broken (see inset at Figure 4-138). The wall louver adjacent to the window, which served the generator room, escaped damage.

There was no apparent structural damage to the 1965 addition. However, the unreinforced brick/CMU parapet shown in Figure 4-139 fell onto the roof, rather than in the other direction, where it would have blocked the entry and possibly could have caused injuries. Virtually all of the exterior windows were broken (see Figures 4-135 and 4-136). The roof insulation and aggregate-ballasted single-ply roof membrane were blown off. The wood roof structure blew off the majority of the 1982 addition (Figures 4-133 and 4-140), and virtually all of the exterior windows were broken.

The precast twin-tees on the ambulance garage blew off and landed against the wall of the 1982 addition (Figures 4-133 and inset at 4-141). The garage door and virtually all of the exterior unreinforced brick/CMU bearing walls collapsed (Figure 4-141). Where the tees rested on the bearing wall, steel bearing plates were embedded in the tee's beams. However, bearing plates had not been embedded on top of the support walls. Rather, where

the tee's beams rested on the wall, a piece of roof membrane had been installed between the beams and the wall. Hence, at the ends of the tees, no uplift resistance was provided other than the tee's dead load.

Figure 4-138:
The sectional door (red arrow) at the generator building was blown in and windows were broken by debris.



Figure 4-139:
Collapsed unreinforced masonry parapet. Note the broken windows.



There were 20 patients and 10 staff in the facility when the tornado struck around 9:45 p.m. Fortunately, the staff was aware of the tornado warning that was issued by the National Weather Service. Patients and staff took refuge in the basement of the 1965 addition per the hospital's tornado plan. Because of the extensive structural and non-structural damage, it was necessary to completely evacuate the hospital after the storm. Evac-

uation was completed by around 2:45 a.m. (about 5 hours after the tornado). None of the occupants were injured during the storm or evacuation. The ambulance shown in Figure 4-141 was not usable because of missile damage. Even though some portions of the facility could be salvaged, significant demolition and reconstruction will be necessary.



Figure 4-140:
Loss of the wood
roof structure at the
1982 addition.



Figure 4-141:
View of the collapsed
ambulance garage.
The twin-tees (red
arrows) flew to the left,
as shown in the inset.



The loss of life and avoidance of injuries was attributed to three factors. 1) A tornado warning was issued by the National Weather Service about 20 minutes before the tornado struck, and the hospital's staff was aware of the warning. 2) The hospital had a tornado evacuation plan and there was sufficient time to execute the plan. 3) Although it is believed that the basement was not specifically designed as a tornado shelter, it provided a safe area of refuge for patients and staff. For hospitals located in tornado-prone regions, the experience from this tornado demonstrates the importance of having a pre-identified, best available refuge area (or preferably a FEMA 361-compliant shelter). Although small interior rooms and corridors sometimes provide adequate protection during tornadoes, unless specifically designed as a tornado shelter, they often provide inadequate protection, as shown in Figure 4-142.

Figure 4-142:
View of a main
corridor in the 1982
addition



It was determined that with minimal work, the basement under the 1965 addition could be used as an interim, best available refuge area for the city. In the weeks and months following the storm, several hundred people would be in the city performing demolition, salvaging personal items, and conducting reconstruction. Much of this work would occur during the time of year when tornado activity is high. Hence, although severely damaged, a portion of the hospital continued to serve the community by providing an interim refuge area.

The damage investigation of this facility validates several of the recommendations provided in Section 4.5, summarized below:

- Incorporate a tornado shelter within the facility.
- Don't use aggregate roof surfacing.
- Use roof decks, exterior walls, and doors as recommended in sections 4.3.2.1, 4.3.3.2, and 4.3.3.6.
- Use laminated glass window assemblies that are designed to resist the test Missile E.

4.5.2 THE CASE OF SUMTER REGIONAL HOSPITAL, AMERICUS, GEORGIA

The previous case study reported on a smaller, older hospital that was struck by a tornado. The case of Sumter Regional Hospital illustrates the performance of a much larger and newer hospital. This hospital is a 143-bed, four-story facility built in 1953, and expanded in 1975, 1983, and 1999. The 1999 addition had a cast-in-place concrete roof deck. All of the other buildings had steel roof decks. Roof coverings included single-ply membranes (exposed and aggregate-balled) and aggregate surfaced built-up. Exterior walls included brick veneer (over unreinforced CMU and over steel studs) and EIFS over steel studs.



Figure 4-143:

Aerial view of the facility after it was struck by the tornado. The red arrow indicates the general direction of the tornado. The blue arrow shows the 1953 building, and the yellow arrow shows the 1999 building. The 1975 and 1983 additions are adjacent to and behind the 1953 and 1999 buildings.

COURTESY OF THE NATIONAL WEATHER SERVICE.

The hospital was struck by a tornado in 2007. The National Weather Service rated a portion of the track as an EF3 (with an estimated peak gust speed between 136 and 165 mph). At the hospital site, the damage was indicative of an EF2 (with a speed between 111 and 135 mph). The 2005 edition of ASCE 7 lists the design wind speed for this location as 90 mph. Therefore, the speeds at this site were well above current design conditions.

Using the Damage Indicators in the Enhanced Fujita Scale (EF-Scale), the Degree of Damage (DOD) at the hospital indicated an expected wind speed during the tornado of 131 mph (with lower and upper bounds ranging from 110 to 152 mph).

As the tornado approached the southwest side of the hospital, numerous tree branches from trees in front of the hospital were thrown against the building. Missiles broke virtually all of the glass in the southwest walls (Figures 4-144 and 4-145), and missiles penetrated the EIFS and landed inside the building. Roof decking and steel joists were blown off of portions of the 1953 building, and the roof

membrane was blown off of several different areas of the facility.

The right (curved) portion of the building in Figure 4-144 is the 1999 addition. This portion of the first floor housed waiting and exam rooms. Offices were on the second floor, and medical offices were on the third floor. Figures 4-144 and 4-146 also show part of the 1953 building. Offices were on the first floor, and patient rooms were on the second and third floors.

Figure 4-144:

The 1999 addition is on the right, and the 1953 building is to the left. Virtually all of the glass on these facades was broken.





Figure 4-145:
One window frame was blown away (red circle). The EIFS was penetrated by many missiles, and in some areas, the entire wall (except the studs) was blown away (arrows).



Figure 4-146:
Several of the window frames were blown away, along with some of the brick veneer (1999 addition).

Broken glass showered the rooms along the exterior walls. The breach of the building envelope allowed strong winds to enter the rooms and corridors, which led to the collapse of suspended acoustical ceilings and light fixtures. Figure 4-147 illustrates the extent of the interior damage.

Figure 4-147:
Glass shards and other debris in the lobby area housing retail shops and offices.



Damage also occurred on other facades, including collapse of a glass curtain wall and a portion of a brick veneer/unreinforced CMU wall (Figure 4-148). A large unreinforced brick chimney collapsed on a roof, and a large rooftop air handling unit (20 x 7 x 9 feet) was shifted several feet. A substantial amount of water entered the building at various places where the envelope was breached.

Much of the aggregate ballast (1½-inch nominal diameter) was blown from the roof, and broke numerous vehicle windows in the parking lot.



Figure 4-148: Collapsed brick veneer/CMU wall at a mechanical room. The cast-in-place concrete wall (arrow) remained, but the brick veneer was blown away.

There were 54 patients in the facility when the tornado struck around 9:15 p.m. Staff was not aware of the approaching tornado until just before it struck. Most of the patients and newborn infants were moved into hallways as the tornado struck the building. Some remained in their beds during the few seconds of the tornado impact. People were injured, but none seriously. Because of the extensive damage, it was necessary to completely evacuate the hospital after the storm. Evacuation was completed by around 2:00 a.m. (about 5 hours after the tornado).

Within a couple of days, an urgent care facility was temporarily set up in a tent. Temporary modular buildings were also brought in to provide space for an expanded array of healthcare services for the community. After approximately 3 months of study, it was decided to demolish the entire hospital complex and build a new facility. An interim facility was expected to be completed by the fall of 2007.

As with the previous case study, the damage investigation of this facility validates several of the recommendations provided in Section 4.5. In particular, this case study validates the recommendations pertaining to use of roof decks, exterior walls, and doors, as recommended

In addition to the impacts on delivery of healthcare to the community, the damage had potential impacts on the economy. The hospital had approximately 700 employees and was one of the largest employers in the county. Had there been significant interruptions in meeting payroll, or had it been decided to close the facility and rely on a hospital that was approximately 40 miles away, the loss of jobs would likely have been difficult on the community.

in sections 4.3.2.1, 4.3.3.2, and 4.3.3.6, and the use of laminated glass window assemblies that are designed to resist the test Missile E. In those instances where there is little or no warning of an impending tornado strike, maintaining building envelope integrity is crucial to providing protection to patients and staff, and in minimizing disruption of services.

4.6 CHECKLIST FOR BUILDING VULNERABILITY OF HOSPITALS EXPOSED TO HIGH WINDS

The Building Vulnerability Assessment Checklist (Table 4-3) is a tool that can help in assessing the vulnerability of various building components during the preliminary design of a new building, or the rehabilitation of an existing building. In addition to examining design issues that affect vulnerability to high winds, the checklist also examines the potential adverse effects on the functionality of the critical and emergency systems upon which most critical facilities depend. The checklist is organized into separate sections, so that each section can be assigned to a subject expert for greater accuracy of the examination. The results should be integrated into a master vulnerability assessment to guide the design process and the choice of appropriate mitigation measures.

Table 4-3: Checklist for Building Vulnerability of Hospitals Exposed to High Winds

Vulnerability Sections	Guidance	Observations
General		
<p>What is the age of the facility, and what building code and edition was used for the design of the building?</p>	<p>Substantial wind load improvements were made to the model building codes in the 1980s. Many buildings constructed prior to these improvements have structural vulnerabilities. Since the 1990s, several additional changes have been made, the majority of which pertain to the building envelope.</p> <p>Older buildings, not designed and constructed in accordance with the practices developed since the early 1990s, are generally more susceptible to damage than newer buildings.</p>	

Table 4-3: Checklist for Building Vulnerability of Hospitals Exposed to High Winds (continued)

Vulnerability Sections	Guidance	Observations
General (continued)		
Is the hospital older than 5 years, or is it located in a zone with basic wind speed greater than 90 mph?	In either case, perform a vulnerability assessment with life-safety issues as the first priority, and property damage and interruption of service as the second priority.	
Site		
What is the design wind speed at the site? Are there topographic features that will result in wind speed-up?	ASCE 7	
What is the wind exposure on site?	Avoid selecting sites in Exposure D, and avoid escarpments and hills	
Are there trees or towers on site?	Avoid trees and towers near the facility. If the site is in a hurricane-prone region, avoid trees and towers near primary access roads.	
Road access	Provide two separate means of access.	
Is the site in a hurricane-prone region?	ASCE 7. If yes, follow hurricane-resistant design guidance.	
If in a hurricane-prone region, are there aggregate surfaced roofs within 1,500 feet of the facility?	Remove aggregate from existing roofs. If the buildings with aggregate are owned by other parties, attempt to negotiate the removal of the aggregate (e.g., consider offering to pay the reroofing costs).	
Architectural		
Will the facility be used as a shelter?	If yes, refer to FEMA 361.	
Are there interior non-load-bearing walls?	Design for wind load.	
Are there multiple buildings on site in a hurricane-prone region?	Provide enclosed walkways between buildings that will be occupied during a hurricane.	
Are multiple elevators needed for the building?	Place elevators in separate locations served by separate penthouses.	

Table 4-3: Checklist for Building Vulnerability of Hospitals Exposed to High Winds (continued)

Vulnerability Sections	Guidance	Observations
Structural Systems	Section 4.3.2	
Is a pre-engineered building being considered?	If yes, ensure the structure is not vulnerable to progressive collapse. If a pre-engineered building exists, evaluate to determine if it is vulnerable to progressive collapse.	
Is precast concrete being considered?	If yes, design the connections to resist wind loads. If precast concrete elements exist, verify that the connections are adequate to resist the wind loads.	
Are exterior load-bearing walls being considered?	If yes, design as MWFRS and C&C.	
Is an FM Global-rated roof assembly specified?	If yes, comply with FM Global deck criteria.	
Is there a covered walkway or canopy?	If yes, use “free roof” pressure coefficients from ASCE 7. Canopy decks and canopy framing members on older buildings often have inadequate wind resistance. Wind-borne debris from canopies can damage adjacent buildings and cause injury.	
Is the site in a hurricane-prone region?	A reinforced cast-in-place concrete structural system, and reinforced concrete or fully grouted and reinforced CMU walls, are recommended.	
Is the site in a tornado-prone region?	If yes, provide occupant protection. See FEMA 361.	
Do portions of the existing facility have long-span roof structures (e.g., a gymnasium)?	Evaluate structural strength, since older long-span structures often have limited uplift resistance.	
Is there adequate uplift resistance of the existing roof deck and deck support structure?	The 1979 (and earlier) SBC and UBC, and 1984 (and earlier) BOCA/NBC, did not prescribe increased wind loads at roof perimeters and corners. Decks (except cast-in-place concrete) and deck support structures designed in accordance with these older codes are quite vulnerable. The strengthening of the deck attachment and deck support structure is recommended for older buildings.	

Table 4-3: Checklist for Building Vulnerability of Hospitals Exposed to High Winds (continued)

Vulnerability Sections	Guidance	Observations
Structural Systems Section 4.3.2 (continued)		
Are there existing roof overhangs that cantilever more than 2 feet?	Overhangs on older buildings often have inadequate uplift resistance.	
Building Envelope Section 4.3.3		
Exterior doors, walls, roof systems, windows, and skylights.	Select materials and systems, and detail to resist wind and wind-driven rain.	
Are soffits considered for the building?	Design to resist wind and wind-driven water infiltration. If there are existing soffits, evaluate their wind and wind-driven rain resistance. If the soffit is the only element preventing wind-driven rain from being blown into an attic space, consider strengthening the soffit.	
Are there elevator penthouses on the roof?	Design to prevent water infiltration at walls, roof, and mechanical penetrations.	
Is a low-slope roof considered on a site in a hurricane-prone region?	A minimum 3-foot parapet is recommended on low-slope roofs.	
Is an EOC, healthcare facility, shelter, or other particularly important hospital in a hurricane-prone region?	If yes, a very robust building envelope, resistant to missile impact, is recommended.	
Is the site in a tornado-prone region?	To minimize generation of wind-borne missiles, avoid the use of brick veneer, aggregate roof surfacing, roof pavers, slate, and tile.	
Are there existing sectional or rolling doors?	Older doors often lack sufficient wind resistance.	
Does the existing building have large windows or curtain walls?	If an older building, evaluate their wind resistance.	
Does the existing building have exterior glazing (windows, glazed doors, or skylights)?	If the building is in a hurricane-prone region, replace with impact-resistant glazing, or protect with shutters.	
Does the existing building have operable windows?	If an older building, evaluate its wind-driven rain resistance.	
Are there existing exterior non-load-bearing masonry walls?	If the building is in a hurricane- or tornado-prone region, strengthen or replace.	

Table 4-3: Checklist for Building Vulnerability of Hospitals Exposed to High Winds (continued)

Vulnerability Sections	Guidance	Observations
Building Envelope Section 4.3.3 (continued)		
Are there existing brick veneer, EIFS, or stucco exterior coverings?	If the building is in a hurricane-prone region, evaluate attachments. To evaluate wind resistance of EIFS, see ASTM E 2359 (2006).	
Are existing exterior walls resistant to wind-borne debris?	If the building is in a hurricane-prone region, consider enhancing debris resistance, particularly if dealing with an important hospital.	
Are there existing ballasted single-ply roof membranes?	Determine if they are in compliance with ANSI/SPRI RP-4. If non-compliant, take corrective action.	
Does the existing roof have aggregate surfacing, lightweight pavers, or cementitious-coated insulation boards?	If the building is in a hurricane-prone region, replace the roof covering to avoid blow-off.	
Does the existing roof have edge flashing or coping?	Evaluate the adequacy of the attachment.	
Does the existing roof system incorporate a secondary membrane?	If not, and if the building is in a hurricane-prone region, reroof and incorporate a secondary membrane into the new system.	
Does the existing building have a brittle roof covering, such as slate or tile?	If the building is in a hurricane-prone region, consider replacing with a non-brittle covering, particularly if it is an important hospital.	
Exterior-Mounted Mechanical Equipment		
Is there mechanical equipment mounted outside at grade or on the roof?	Anchor the equipment to resist wind loads. If there is existing equipment, evaluate the adequacy of the attachment, including attachment of cowlings and access panels.	
Are there penetrations through the roof?	Design intakes and exhausts to avoid water leakage.	
Is the site in a hurricane-prone region?	If yes, place the equipment in a penthouse, rather than exposed on the roof.	
Exterior-Mounted Electrical and Communications Equipment		
Are there antennae (communication masts) or satellite dishes?	If there are existing antennae or satellite dishes and the building is located in a hurricane-prone region, evaluate wind resistance. For antennae evaluation, see Chapter 15 of ANSI/TIA-222-G-2005.	

Table 4-3: Checklist for Building Vulnerability of Hospitals Exposed to High Winds (continued)

Vulnerability Sections	Guidance	Observations
Exterior-Mounted Electrical and Communications Equipment (continued)		
Does the building have a lightning protection system?	See Sections 4.3.4.4 and 4.4.3.2 for lightning protection system attachment. For existing lightning protection systems, evaluate wind resistance, see Section 4.4.3.2.	
Municipal Utilities		
Is the site in a hurricane-prone region?	See Section 4.3.5.1 for emergency and standby power recommendations.	
Is the emergency generator(s) housed in a wind- and debris-resistant enclosure?	If not, build an enclosure to provide debris protection in a hurricane-prone region.	
Is the emergency generator's wall louver protected from wind-borne debris?	If the building is in a hurricane-prone region, install louver debris impact protection.	
Is the site in a hurricane-prone region?	If yes, an independent water supply and alternative means of sewer service are recommended, independent of municipal services.	

4.7 REFERENCES AND SOURCES OF ADDITIONAL INFORMATION

Note: FEMA publications may be obtained at no cost by calling (800) 480-2520, faxing a request to (301) 497-6378, or downloading from the library/publications section online at <http://www.fema.gov>.

American Association of State Highway and Transportation Officials, *Standard Specifications for Structural Supports for Highway Signs, Luminaires and Traffic Signals*, LTS-4-M and LTS-4-12, January 2001 and October 2003.

American Concrete Institute, ASCE, The Masonry Society, *Building Code Requirements for Masonry Structures*, ACI 530/ASCE 5/TMS 402, 2005.

American Institute of Architects, *Buildings at Risk: Wind Design Basics for Practicing Architects*, 1997.

American National Standards Institute/SPRI RP-4, *Wind Design Standard for Ballasted Single-Ply Roofing Systems*, 2002.

American National Standards Institute/SPRI ES-1, *Wind Design Standard for Edge Systems Used in Low Slope Roofing Systems*, 2003.

American National Standards Institute/Telecommunications Industry Association, *Structural Standards for Antenna Supporting Structures and Antennas*, ANSI/TIA-222-G, August 2005.

American Red Cross, *Standards for Hurricane Evacuation Shelter Selection*, Publication 4496, July 1992, rev. January 2002.

American Society of Civil Engineers, *Structural Engineering Institute, Minimum Design Loads for Buildings and Other Structures*, ASCE/SEI 7-05, Reston, VA, 2005.

American Society for Testing and Materials, *Standard Test Method for Field Determination of Water Penetration of Installed Exterior Windows, Skylights, Doors, and Curtain Walls by Uniform or Cyclic Static Air Pressure Difference*, ASTM E1105, 2000.

American Society for Testing and Materials, *Standard Test Method for Structural Performance of Sheet Metal Roof and Siding Systems by Uniform Static Air Pressure Difference*, ASTM E1592, 2000.

American Society for Testing and Materials, *Standard Test Method for Structural Performance of Exterior Windows, Curtain Walls, and Doors by Cyclic Static Air Pressure Differential*, ASTM E1233, December 2000.

American Society for Testing and Materials, *Standard Practice for Installation of Exterior Windows, Doors and Skylights*, ASTM E2112, 2001.

American Society for Testing and Materials, *Standard Test Method for Performance of Exterior Windows, Curtain Walls, Doors, and Impact Protective Systems Impacted by Missile(s) and Exposed to Cyclic Pressure Differentials*, ASTM E1886, 2005.

American Society for Testing and Materials, *Standard Specification for Performance of Exterior Windows, Curtain Walls, Doors and Impact Protective Systems Impacted by Windborne Debris in Hurricanes*, ASTM E1996, 2005.

American Society for Testing and Materials, *Standard Specification for Zinc Coating (Hot-Dip) on Iron and Steel Hardware*, ASTM A153, April 2005.

American Society for Testing and Materials, *Standard Specification for Steel, Sheet, Cold-Rolled, Carbon, Structural, High-Strength Low-Alloy, High-Strength Low-Alloy with Improved Formability, Solution Hardened, and Bake Hardenable*, ASTM A1008/A1008M, 2006.

American Society for Testing and Materials, *Test Method for Field Pull Testing of an In-Place Exterior Insulation and Finish System Clad Wall Assembly*, ASTM E 2359, 2006.

American Society for Testing and Materials, *Standard Test Method for Structural Performance of Exterior Windows, Doors, Skylights, and Curtain Walls by Cyclic Air Pressure Differential*, ASTM E1233, 2006.

American Society of Heating, Refrigeration and Air-Conditioning Engineers, Inc. (ASHRAE), *Ventilation for Acceptable Indoor Air Quality*, Standard 62.1, 2004.

American Society of Heating, Refrigeration and Air-Conditioning Engineers, Inc. (ASHRAE), *Standard 62.1 User's Manual*, 2006.

Brick Industry Association, *Anchored Brick Veneer-Wood Frame Construction*, Technical Notes 28, Revised August 2002.

Brick Industry Association, *Wall Ties for Brick Masonry*, Technical Notes 44B, Revised May 2003.

Brick Industry Association, *Brick Veneer/Steel Stud Walls*, Technical Notes 28B, December 2005.

Door & Access Systems Manufacturers Association, *Connecting Garage Door Jambs to Building Framing*, Technical Data Sheet #161, December 2003.

FM Global, *Loss Prevention Data for Roofing Contractors*, Norwood, MA, dates vary.

Factory Mutual Research, *Approval Guide*, Norwood, MA, updated quarterly.

FEMA, *Building Performance: Hurricane Andrew in Florida*, FEMA FIA-22, Washington, DC, December 1992.

FEMA, *Building Performance: Hurricane Iniki in Hawaii*, FEMA FIA-23, Washington, DC, January 1993.

FEMA, *Corrosion Protection for Metal Connectors in Coastal Areas*, FEMA Technical Bulletin 8-96, Washington, DC, August 1996.

FEMA, *Typhoon Paka: Observations and Recommendations on Building Performance and Electrical Power Distribution System*, FEMA-1193-DR-GU, Washington, DC, March 1998.

FEMA, *Hurricane Georges in Puerto Rico*, FEMA 339, Washington, DC, March 1999.

FEMA, *Oklahoma and Kansas Midwest Tornadoes of May 3, 1999*, FEMA 342, Washington, DC, October 1999.

FEMA, *Coastal Construction Manual*, Third Edition, FEMA 55, Washington, DC, 2000.

FEMA, *Design and Construction Guidance for Community Shelters*, FEMA 361, Washington, DC, July 2000.

FEMA, *Installing Seismic Restraints for Mechanical Equipment*, FEMA 412, Washington, DC, December 2002.

FEMA, *Tornado Protection, Selecting Safe Areas in Buildings*, FEMA 431, Washington, DC, October 2003.

FEMA, *Installing Seismic Restraints for Electrical Equipment*, FEMA 413, Washington, DC, January 2004.

FEMA, *Installing Seismic Restraints for Duct and Pipe*, FEMA 414, Washington, DC, January 2004.

FEMA, *Taking Shelter From the Storm: Building a Safe Room Inside Your House*, FEMA 320, Washington, DC, March 2004.

FEMA, *MAT Report: Hurricane Charley in Florida*, FEMA 488, Washington, DC, April 2005.

FEMA, *MAT Report: Hurricane Ivan in Alabama and Florida*, FEMA 489, Washington, DC, August 2005.

FEMA, *Home Builder's Guide to Coastal Construction Technical Fact Sheet Series*, FEMA 499, August 2005.

FEMA, *Attachment of Brick Veneer in High-Wind Regions—Hurricane Katrina Recovery Advisory*, Washington, DC, December 2005.

FEMA, *MAT Report: Hurricane Katrina in the Gulf Coast*, FEMA 549, Washington, DC, July 2006.

FEMA, *Attachment of Rooftop Equipment in High-Wind Regions—Hurricane Katrina Recovery Advisory*, Washington, DC, May 2006, rev. July 2006.

FEMA, *Rooftop Attachment of Lighting Protection Systems in High-Wind Regions—Hurricane Katrina Recovery Advisory*, Washington, DC, May 2006, rev. July 2006.

Institute of Electrical and Electronics Engineers, Inc., *National Electrical Safety Code*, ANSI/IEEE/C2, 2006.

International Code Council, *2006 International Building Code*, ICC IBC-2006, March 2006.

McDonald, J.R. and Lea, P.A., *A Study of Building Damage Caused by Wind Forces*, Institute for Disaster Research, Texas Tech University, 1978.

ABFE	Advisory Base Flood Elevation
ACI	American Concrete Institute
ADA	Americans with Disabilities Act
ANSI	American National Standards Institute
ASCE	American Society of Civil Engineers
ASHRAE	American Society of Heating, Refrigeration and Air-Conditioning Engineers, Inc.
ASTM	American Society for Testing and Materials
BCFH	Boulder Community Foothills Hospital
BFE	Base Flood Elevation
BIA	Brick Industry Association
BOCA	Building Officials and Code Administrators International, Inc.
BURs	Built-Up Roofs
C&C	Components and Cladding
CMU	Concrete Masonry Unit
DFE	Design Flood Elevation
EERI	Earthquake Engineering Research Institute
EIFS	Exterior Insulation Finish Systems
ELF	Equivalent Lateral Force
EMS	Emergency Medical Service
EOC	Emergency Operation Center
ER	Emergency Room
FEMA	Federal Emergency Management Agency
FIRMs	Flood Insurance Rate Maps
FISs	Flood Insurance Studies
FMG	Factory Mutual Global

FMR	Factory Mutual Research
GAO	General Accounting Office
HSSA	Hospital Seismic Safety Act (California)
HVAC	Heating, Ventilating, and Air-Conditioning
IBC	International Building Code
ICBO	International Conference of Building Officials
ICC	International Code Council
ICU	Intensive Care Unit
IEE	Institute of Electrical and Electronics Engineers, Inc.
KCH	Kona Community Hospital
LACDHS	Los Angeles County, Department of Health Services
LPS	Lightning Protection System
M/E/P	Mechanical/Electrical/Plumbing
MEPS	Molded Expanded Polystyrene
MMI	Modified Mercalli Intensity
MOB	Medical Office Building
MWFRS	Main Wind-Force Resisting System
NBC	National Building Code
NEHRP	National Earthquake Hazard Reduction Program
NFIP	National Flood Insurance Program
NFPA	National Fire Protection Association
NIBS	National Institute of Building Sciences
NOAA	National Oceanic and Atmospheric Administration
NSC	Nonstructural Seismic Coordinator
OR	operating room
OSB	Oriented Strand Board
OSHDP	Office of Statewide Health Planning and Development (California)
PCI	Precast/Prestressed Concrete Institute
PGA	Peak Ground Acceleration
PMRs	Protected Membrane Roof

REACH	Rapid Evaluation and Assessment Checklist
SBC	Standard Building Code
SBCCI	Southern Building Code Congress International, Inc.
SDC	Seismic Design Category
SPF	Sprayed Polyurethane Foam
TIA	Telecommunications Industry Association
USACE	U.S. Army Corp of Engineers
UBC	Uniform Building Code
URM	Unreinforced Masonry
USGS	U. S. Geological Survey
VA	U.S. Department of Veterans Affairs
VSI	Vinyl Siding Institute

100-year flood. See “base flood.”

A

Astragal. The center member of a double door, which is attached to the fixed or inactive door panel.

B

Base flood. The flood having a 1 percent chance of being equaled or exceeded in any given year, commonly referred to as the “100-year flood.” The base flood is the national standard used by the NFIP and all Federal agencies for the purposes of requiring the purchase of flood insurance and regulating new development.

Base flood elevation (BFE). The height of the base (1 percent or 100-year) flood in relation to a specified datum, usually the National Geodetic Vertical Datum of 1929, or the North American Vertical Datum of 1988.

Base isolation. Also called seismic isolation. A design concept that reduces the earthquake motions in the building superstructure by isolating the building from ground motions.

Basic wind speed. A 3-second gust speed at 33 feet above the ground in Exposure C. (Exposure C is flat open terrain with scattered obstructions having heights generally less than 30 feet.) Note: Since 1995, ASCE 7 has used a 3-second peak gust measuring time. A 3-second peak gust is the maximum instantaneous speed with a duration of approximately 3 seconds. A 3-second peak gust speed could be associated with a given windstorm (e.g., a particular storm could have a 40-mph peak gust speed), or a 3-second peak gust speed could be associated with a design-level event (e.g., the basic wind speed prescribed in ASCE 7).

Building configuration. Size, shape, and proportions of the building; size, shape, and location of structural elements; and the type, size, and location of nonstructural elements.

Building, enclosed. A building that does not comply with the requirements for open or partially enclosed buildings.

Building, open. A building having each wall at least 80 percent open. This condition is expressed by an equation in ASCE 7.

Building, partially enclosed. A building that complies with both of the following conditions:

1. The total area of openings in a wall that receives positive external pressure exceeds the

sum of the areas of openings in the balance of the building envelope (walls and roof) by more than 10 percent.

2. The total area of openings in a wall that receives positive external pressure exceeds 4 square feet, or 1 percent of the area of that wall, whichever is smaller, and the percentage of openings in the balance of the building envelope does not exceed 20 percent.

These conditions are expressed by equations in ASCE 7.

Building, period. The rate at which a building will vibrate as a result of ground motion.

Building, regularly shaped. A building having no unusual geometrical irregularity in spatial form.

Building, simple diaphragm. An enclosed or partially enclosed building in which wind loads are transmitted through floor and roof diaphragms to the vertical main wind-force resisting system.

C

Coastal Flooding. The accumulation of water experienced along the Atlantic, Gulf, and Pacific coasts, and the Great Lakes due to storm surges, extratropical systems, tsunamis, and sometimes wind-driven waves.

Components and cladding (C&C). Elements of the building envelope that do not qualify as part of the main wind-force resisting system.

Coping. The cover piece on top of a wall exposed to the weather, usually made of metal, masonry, or stone, and sloped to carry off water.

D

Damping. The rate at which natural vibration decays as a result of the absorption of energy. In buildings it is an inherent nature to resonate inefficiently to vibration depending on structural connections, kinds of materials, and nonstructural elements used. “Damping” design measures can reduce the magnitude of seismic forces.

Design flood. The greater of the following two flood events: (1) the base flood, affecting those areas identified as special flood hazard areas on a community’s Flood Insurance Rate Map (FIRM); or (2) the flood corresponding to the area designated as a flood hazard area on a community’s flood hazard map or otherwise legally designated.

Design flood elevation (DFE). The elevation of the design flood, including wave height, relative to the datum specified on a community’s flood hazard map.

Downburst. Also known as a microburst. A powerful downdraft associated with a thunderstorm.

Down-slope wind. A wind blowing down the slope of mountains (frequently occurs in Alaska and Colorado).

Drift. The term used in seismic design to describe the horizontal deflection of structural members in response to seismic forces.

Dry floodproofing. An adjustment, modification, or addition of a feature, or any combination thereof, that eliminates or reduces the potential for flood damage by sealing walls and closing openings to keep water from entering a building.

Ductility. The characteristic of certain materials—steel in particular—to fail only after considerable distortion or deformation has occurred.

E

Escarpment. Also known as a scarp. With respect to topographic effects, a cliff or steep slope generally separating two levels or gently sloping areas.

Equivalent Lateral Force (ELF) Procedure. A procedure used in building design that allows adjustments of the design force for varying site seismicities, alternative soil types, different structural and nonstructural systems and materials, different building heights, and occupancies of varying importance.

Epicenter. The epicenter is the place on the surface of the earth under which an earthquake rupture originates, often given in degrees of latitude and longitude.

Exposure. The characteristics of the ground roughness and surface irregularities in the vicinity of a building. ASCE 7 defines three exposure categories—Exposures B, C, and D.

Extratropical storm. A cyclonic storm that forms outside of the tropical zone. Extratropical storms may be large, often 1,500 miles (2,400 kilometers) in diameter, and usually contain a cold front that extends toward the equator for hundreds of miles.

F

Fault. A fault is a fracture along which the blocks of earth's crust on either side have moved relative to one another parallel to the fracture.

Federal Emergency Management Agency (FEMA). The Federal Emergency Management Agency is the Federal agency which administers the National Flood Insurance Program (NFIP).

Flashing. Any piece of material, usually metal or plastic, installed to prevent water from penetrating a structure.

Flood Insurance Rate Map (FIRM). The official map of a community on which FEMA has delineated both the special hazard areas, and the risk premium zones applicable to the community.

Flood Insurance Study (FIS). An engineering study performed by FEMA to identify flood hazard areas, flood insurance risk zones, and other flood data in a community; used in the development of the FIRM.

Floodplain. Any land area, including the watercourse, that is susceptible to partial or complete inundation by water, from any source.

Floodplain management regulations. Zoning ordinances, subdivision regulations, building codes, or special-purpose ordinances that set flood-resistant standards for new construction, land use, and development.

Flood profile. A graph of computed flood elevations at points located along a riverine waterway. A flood profile typically is available for a waterway that has Base Flood Elevations (BFEs) shown on the Flood Insurance Rate Map (FIRM). Flood profiles are usually found in the Flood Insurance Study (FIS) report.

Floodway. The channel and that portion of the floodplain that is to be reserved to convey the base flood, without cumulatively increasing the water surface elevation more than a designated height.

Floodway fringe. The area of the floodplain outside of the floodway, where floodwaters may be shallower and slower.

Freeboard. A factor of safety, usually expressed in feet above a flood level, for purposes of floodplain management. Freeboard also compensates for the many unknown factors that could contribute to flood heights greater than the height calculated for a selected size flood and floodway conditions, such as wave action, constricting bridge openings, and the hydrological effect of urbanization of the watershed. A freeboard of from 1 to 3 feet is often applied to critical facilities.

G

Glazing. Glass or a transparent or translucent plastic sheet used in windows, doors, and skylights.

Glazing, impact-resistant. Glazing that has been shown, by an approved test method, to withstand the impact of wind-borne missiles likely to be generated in wind-borne debris regions during design winds.

Ground motion. The movement of the earth's surface from earthquakes or explosions. Ground motion is produced by waves that are generated by sudden slip on a fault or sudden pressure at the explosive source, and travel through the earth and along its surface.

H

Hurricane-prone regions. Areas vulnerable to hurricanes; in the United States and its territories defined as:

1. The U.S. Atlantic Ocean and Gulf of Mexico coasts, where the basic wind speed is greater than 90 miles per hour.

2. Hawaii, Puerto Rico, Guam, U.S. Virgin Islands, and American Samoa.

Human intervention. The presence and active involvement of people necessary to enact or implement floodproofing measures prior to the onset of flooding.

Hydrodynamic load. Loads imposed by water flowing against and around an object or structure, including the impacts of debris and waves.

Hydrostatic load. Load (pressure) imposed on an object or structure by a standing mass of water; the deeper the water, the greater the load or pressure against the object or structure.

Impact-resistant covering. A covering designed to protect glazing, which has been shown by an approved test method to withstand the impact of wind-borne missiles likely to be generated in wind-borne debris regions during design winds.

Importance factor, I . A factor that accounts for the degree of hazard to human life and damage to property. Importance factors are given in ASCE 7.

Landslides. The slipping of soil and rock on sloping ground triggered by earthquake ground motion.

Liquefaction. The temporary change of loose granular soils and sand in the presence of water from a solid to a liquid state when subjected to ground shaking.

Lowest floor. The lowest floor of the lowest enclosed area (including basement). An unfinished or flood-resistant enclosure, usable solely for parking of vehicles, building access, or storage, in an area other than a basement area, is not considered a building's lowest floor, provided that the enclosure is compliant with flood-resistant requirements.

Magnitude. The magnitude is a number that characterizes the relative size of an earthquake. Magnitude is based on measurement of the maximum motion recorded by a seismograph. Best known scales are "Richter magnitude," and "moment magnitude." The moment magnitude (M_w) scale, based on the concept of seismic moment, is uniformly applicable to all sizes of earthquakes.

Main wind-force resisting system. An assemblage of structural elements assigned to provide support and stability for the overall structure. The system generally receives wind loading from more than one surface.

Mean roof height, (h). The average of the roof eave height and the height to the highest point on the roof surface, except that, for roof angles of less than or equal to 10 degrees, the mean roof height shall be the roof eave height.

Missiles. Debris that could become propelled into the wind stream.

Modified Mercalli Intensity (MMI) scale. Intensity scale used to measure the level of earthquake damage.

Moment Frame. Frames in which structural members and joints resist lateral forces by bending. There are “ordinary,” “intermediate,” and “special” moment frames. The latter provide the most resistance.

N

National Flood Insurance Program (NFIP). A Federal program to identify flood-prone areas nationwide, and make flood insurance available for properties in communities that participate in the program.

NEHRP. The Federal National Earthquake Hazard Reduction Program, enacted in 1977, to reduce potential losses from earthquakes by funding research in earthquake prediction and hazards and to guide the implementation of earthquake loss-reduction programs.

Nor'easter. Nor'easters are non-tropical storms that typically occur in the eastern United States, any time between October and April, when moisture and cold air are plentiful. They are known for dumping heavy amounts of rain and snow, producing hurricane-force winds, and creating high surfs that cause severe beach erosion and coastal flooding. A nor'easter is named for the winds that blow in from the northeast and drive the storm along the east coast and the Gulf Stream, a band of warm water that lies off the Atlantic Coast.

O

Openings. Apertures or holes in the building envelope that allow air to flow through the building envelope. A door that is intended to be in the closed position during a windstorm would not be considered an opening. Glazed openings are also not typically considered openings. However, if the building is located in a wind-borne debris region and the glazing is not impact-resistant or protected with an impact-resistant covering, the glazing is considered an opening.

P

Passive Energy Dissipation. The reduction of earthquake forces in a building by the introduction of devices designed to dissipate the earthquake energy in a controlled manner using friction, hydraulics, or deformation of material specially placed for this purpose.

Peak Ground Acceleration. The largest acceleration that occurs during earthquake-induced ground motion.

R

Racking. Lateral deflection of a structure resulting from external forces, such as wind or lateral ground movement in an earthquake.

Resonance. The increase in vibrations and accelerations to a vibrating building from the transmission of ground motion.

Response spectrum. A characterization of ground motion (representing the suite of spectral ordinates) measuring the extent of shaking different structures will experience based on their natural period of vibration.

Richter magnitude scale. Developed in 1935 by Charles F. Richter of the California Institute of Technology. The magnitude of an earthquake is determined from the logarithm of the amplitude of waves recorded by seismographs. Adjustments are included for the variation in the distance between the various seismographs and the epicenter of the earthquakes. On the Richter Scale, magnitude is expressed in whole numbers and decimal fractions. For example, a magnitude 5.3 might be computed for a moderate earthquake, and a strong earthquake might be rated as magnitude 6.3. Because of the logarithmic basis of the scale, each whole number increase in magnitude represents a tenfold increase in measured amplitude; as an estimate of energy, each whole number step in the magnitude scale corresponds to the release of about 31 times more energy than the amount associated with the preceding whole number value.

Ridge. With respect to topographic effects, an elongated crest of a hill characterized by strong relief in two directions.

Riverine Flooding. The accumulation of runoff from rainfall or snowmelt, such that the volume of flow exceeds the capacity of waterway channels and spreads out over the adjacent land.

S

Seiche. A wave that oscillates in lakes, bays, or gulfs from a few minutes to a few hours as a result of seismic or atmospheric disturbances.

Seismic ground motion. The movement of ground surfaces in every direction simultaneously, back and forth, side to side, and up and down during an earthquake.

Seismograph. Also known as seismometer, is an instrument used to detect and record earthquakes. Generally, it consists of a mass attached to a fixed base. During an earthquake, the base moves and the mass does not. The motion of the base with respect to the mass is commonly transformed into an electrical voltage. The electrical voltage is recorded on paper, magnetic tape, or another recording medium. This record is proportional to the motion of the seismometer mass relative to the earth, but it can be mathematically converted to a record of the absolute motion of the ground.

Shear. A force that causes parts of a material to slide past one another in opposite directions

Shear wall. Solid wall that resists shear forces, used in buildings constructed in earthquake and high-wind zones.

Sheetflow. Rainfall runoff that flows over relatively flat land without concentrating into streams or channels.

Spectral Acceleration. The acceleration to be experienced by structures of different periods.

Stiffness. Rigidity, or resistance to deflection or drift. A measure of deflection or of staying in alignment within a certain stress.

Stillwater elevation. The elevation that the surface of coastal flood waters would assume in the absence of waves, referenced to a datum.

Straight-line wind. A wind blowing in a straight line with wind speeds ranging from very low to very high (the most common wind occurring throughout United States and its territories).

Substantial damage. Damage of any origin sustained by a structure, whereby the cost of restoring the structure to its predamage condition equals or exceeds 50 percent of the market value of the structure before the damage occurred (or smaller percentage if established by the authority having jurisdiction). Structures that are determined to be substantially damaged are considered to be substantial improvements, regardless of the actual repair work performed.

Substantial improvement. Any reconstruction, rehabilitation, addition, or other improvement of a structure, the cost of which equals or exceeds 50 percent of the market value of the structure (or smaller percentage if established by the authority having jurisdiction) before the start of the improvement.

T

Torsion. Twisting around an axis. The center of the mass does not coincide with the center of resultant force of the resisting building elements causing rotation or twisting action in plans and stress concentrations. Symmetry in general reduces torsion.

Tsunami. An unusually large sea wave produced by submarine earth movement or a volcanic eruption.

W

Wet floodproofing. Permanent or contingent measures and construction techniques, applied to a structure or its contents, that prevent or provide resistance to damage from flooding while allowing floodwaters to enter the structure. Generally, this includes properly anchoring the

structure, using flood-resistant materials below the BFE, protection of mechanical and utility equipment, and the use of openings or breakaway walls.

Wind-borne debris regions. Areas within hurricane-prone regions located:

1. Within 1 mile of the coastal mean high water line, where the basic wind speed is equal to or greater than 110 mph, and in Hawaii.
2. In areas where the basic wind speed is equal to or greater than 120 mph.